

NDA-8002-PLEN In-ceiling plenum rated kit



- ▶ Corrosion-resistant finish
- ▶ Easy installation

The plenum-rated mount kit is easy to install and has a corrosion-resistant finish. This mount kit comes with a microphone support. The plenum-rated mount kit is compatible with the FLEXIDOME 8100i cameras.

Regulatory information

Environmental

Vibration	IEC 60068-2-6
Shock	IEC60068-2-27
Impact	IK04
Fire test	UL 2043

Installation/configuration notes

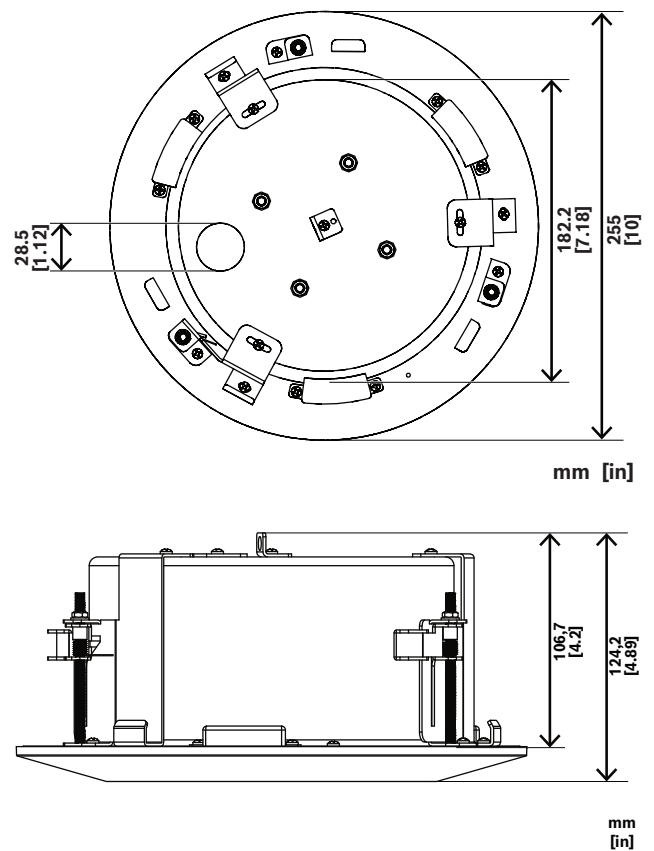

Fig. 1: NDA-8002-PLEN IR

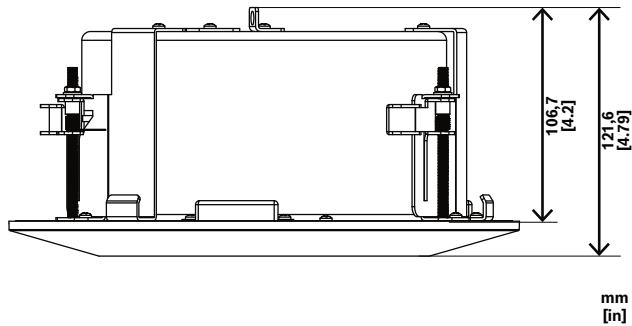

Fig. 2: NDA-8002-PLEN Non-IR
Dimensions in mm (inch)

Parts included

Quantity	Component
1	Mount kit
1	IR decoration plate
4	M6 x 10 mm T25 screw
4	M6 x 12 + 6 mm copper column screw
4	M6 x 30 + 6 mm copper column screw
1	Mounting template sticker
1	Quick installation guide

Technical specifications

Mechanical

Dimensions (Ø x H) (mm) IR	255 mm x 124.2 mm
Dimensions (Ø x H) (in) IR	10 in x 4.89 in
Dimensions (Ø x H) (mm) Non-IR	255 mm x 121.6 mm
Dimensions (Ø x H) (in) Non-IR	10 in x 4.79 in
Weight (kg)	1.600 kg
Weight (lb)	3.53 lb
Color (RAL)	RAL 9003 Signal white
Material	Steel; Polycarbonate
Mounting type	Ceiling-mounted

Ordering information

NDA-8002-PLEN In-ceiling plenum rated kit

Plenum-rated in-ceiling mount kit for FLEXIDOME IP 8000i and FLEXIDOME 8100i cameras.

Order number **NDA-8002-PLEN**



<https://www.boschsecurity.com>