



LB20 EVAC Cabinet Loudspeaker Models

LB20-PC60EW-5D | LB20-PC60EW-5L



BOSCH

en Installation manual

Table of contents

1	Safety	4
1.1	Suspension	4
1.2	Notices	4
2	Introduction	5
2.1	System features	5
2.2	Product information	5
2.3	Packing list	6
3	Installation and wiring	7
3.1	Installing the speaker	7
3.2	U-Bracket installation options	8
3.3	Wiring	9
3.4	Transformer taps	10
3.5	Replacing the logo	11
4	Troubleshooting	12
5	Technical data	13
5.1	Dimensions	14
5.2	Frequency response and impedance	14
6	U-Bracket dimensions	15

1 Safety

1.1 Suspension



Warning!

Suspending any object is potentially dangerous and should only be attempted by individuals who have thorough knowledge of the techniques and regulations of suspending objects overhead. Bosch strongly recommends all loudspeakers be suspended taking into account all current national, federal, state, and local laws and regulations. It is the responsibility of the installer to ensure all loudspeakers are safely installed in accordance with all such requirements. When loudspeakers are suspended, Bosch strongly recommends the system be inspected at least once per year or as laws and regulations require. If any sign of weakness or damage is detected, remedial action should be taken immediately. The user is responsible for making sure the wall, ceiling, or structure is capable of supporting all objects suspended overhead. Any hardware used to suspend a loudspeaker not associated with Bosch is the responsibility of others.

Safety point

As an added safety measure, it is suggested the user install an extra suspension point back to the building structural supports. This safety point should have as little slack as possible (less than 1-inch is preferable).

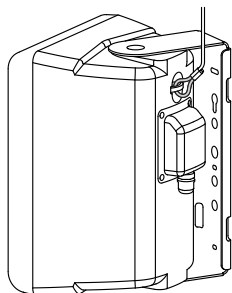
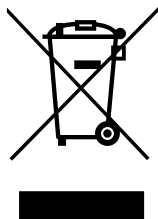

Figure 1.1: Redundant safety point

1.2



Notices

Old electrical and electronic appliances

Electrical or electronic devices that are no longer serviceable must be collected separately and sent for environmentally compatible recycling (in accordance with the European Waste Electrical and Electronic Equipment Directive).

To dispose of old electrical or electronic devices, you should use the return and collection systems put in place in the country concerned.

Copyright and disclaimer

All rights reserved. No part of this document may be reproduced or transmitted in any form by any means, electronic, mechanical, photocopying, recording, or otherwise, without the prior written permission of the publisher. For information on getting permission for reprints and excerpts, contact Bosch Security Systems, Inc.

The content and illustrations are subject to change without prior notice.

2 Introduction

The LB20 premium cabinet loudspeakers from Bosch Security Systems, Inc is a line of compact, high-performance, two-way, full-range surface mount loudspeakers with excellent wide and uniform coverage, and outstanding performance. Their design makes these practically invisible for use in background and foreground music, paging, and sound reinforcement applications, making them ideal for indoor and outdoor applications, such as restaurants, bars, patios, retail, fitness clubs, hospitality, theme parks, leisure venues, and others. With unparalleled ease-of-installation, sturdy weather resistance, modern and delicate look, and flexible mounting options, the LB20 premium cabinet loudspeakers are the perfect solution for a wide variety of surface mount applications.

The LB20-PC60EW-5 models are IP65 rated, designed to withstand the toughest weather conditions.

Read through this manual to familiarize yourself with the safety information, features, and applications before you use these products.

2.1 System features

- Carefully engineered for the toughest weather conditions (IP65)
- Long throw 5.25" (133 mm) woofer housed in a UL 94-5VB fire rated ABS plastic for extended LF performance down to 55 Hz
- 90 W power handling provides for 108 dB maximum SPL (114 dB Peak)
- 60 W transformer with 8 Ω pass-through

2.2 Product information

Item	Description
A	Grille
B	Safety cable loop
C	Weather input cover
D	Gland nut
E	U-Bracket

Tab. 2.1: Product information

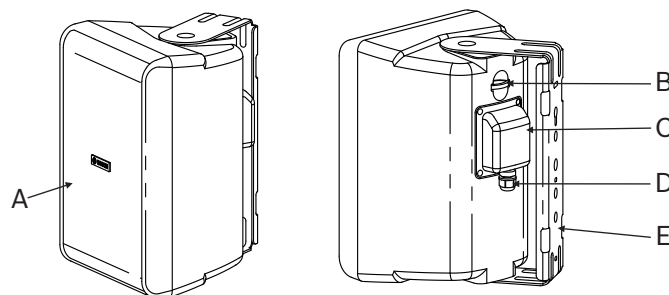

Figure 2.1: Product information

2.3

Packing list

Item	Quantity	Component
A	2	Speakers
B	1	Allen wrench
C	4	Safety screws for the U-Brackets
D	2	U-bracket
E	2	Weather covers
F	8	Weather cover screws
G	2	Grille logos (spares)
H	1	Installation manual

Tab. 2.2: Components list

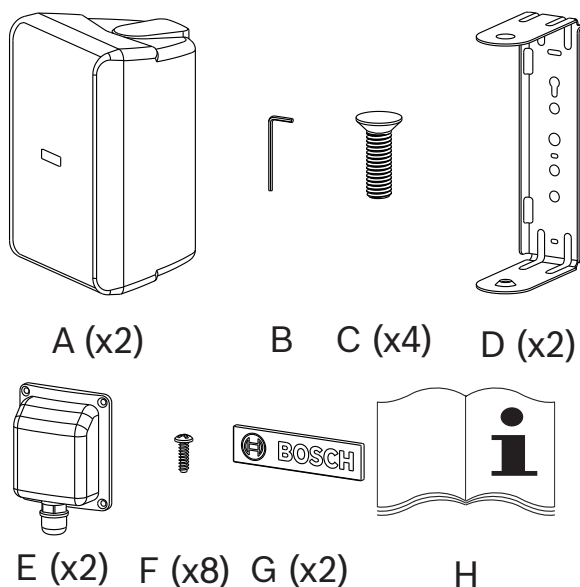

Figure 2.2: Components list

3 Installation and wiring

3.1 Installing the speaker

For safety, ensure the mounting surface supports more than the weight of the speaker. Use only industry-accepted fasteners and mounting methods when mounting the U-Bracket. Consult an expert if you are unsure.



Caution!

It is the installer's responsibility to determine and use the proper mounting hardware for the wall construction type.

Disregarding this caution could result in damage to the product and personal injuries may occur.

Installing the U-Bracket

To **install the U-bracket**, do the following:

1. Draw a **level line**.
2. Align **screw holes** on the level line.
3. Install **two mounting screws** to secure the U-Bracket to the wall.

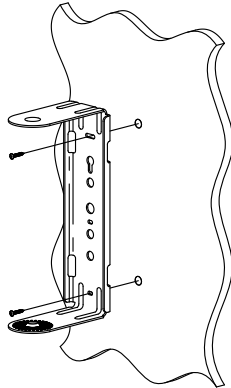

Installing the speaker

To **install the speaker**, do the following:

1. Wire the **speaker**, as shown in the wiring section.
2. Insert the **two screws** (provided) into the U-Bracket mounting points.
Loosely tighten the two screws using the Allen wrench (provided).

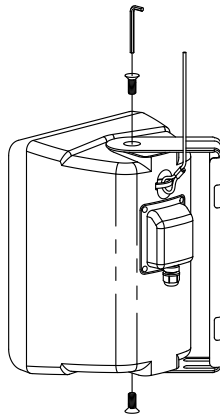

3. Aim the **speaker**.
4. Tighten the **two screws** to secure the U-Bracket to the speaker.
Ensure the speaker is secured to the U-Bracket.

Safety point

As an added safety measure, it is suggested the user install an extra suspension point back to the building structural supports. This safety point should have as little slack as possible (less than 1-inch is preferable).

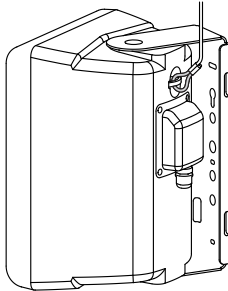

Figure 3.1: Redundant safety point

See also

- *U-Bracket installation options, page 8*
- *Wiring, page 9*

3.2**U-Bracket installation options****Using a U-Bolt**

The U-Bracket can be mounted using a standard 2-inch or 4-inch U-Bolt.

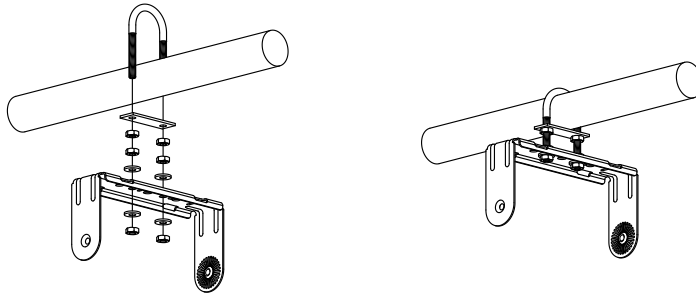

Figure 3.2: U-Bolt – 2-inch

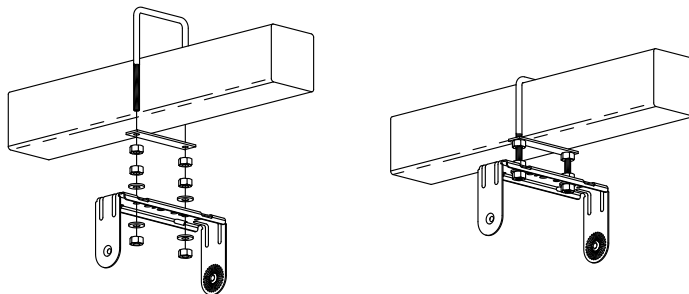

Figure 3.3: U-Bolt – 4-inch

Using a threaded rod

The U-Bracket can be installed to a threaded rod.

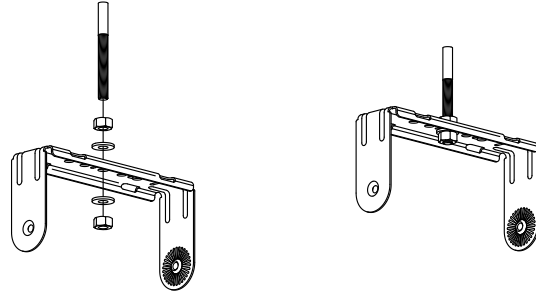

Figure 3.4: Threaded rod

Using a pole mount

The U-Bracket can be installed to a pole mount using steel band clamps.

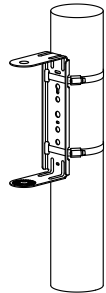

Figure 3.5: Pole mount

Using a junction box

The U-Bracket can be installed to a junction box using a 0.25" rubber grommet (not included) for wiring.

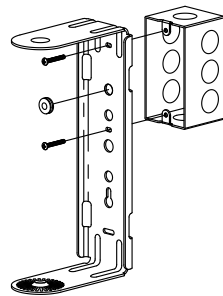

Figure 3.6: Junction box

See also

- *Installing the speaker, page 7*

3.3

Wiring

Wiring the speaker

The speaker can be wired using either 2-wires, for input only, or 4-wires, for input and parallel output. Reference the polarity markers on the Euroblock.

To **wire the speaker using the weather cover**, do the following:

1. Push the **wire** through the gland nut.

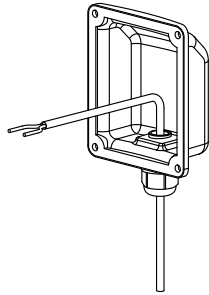

2. Wire the **Euroblock connector (A)**.

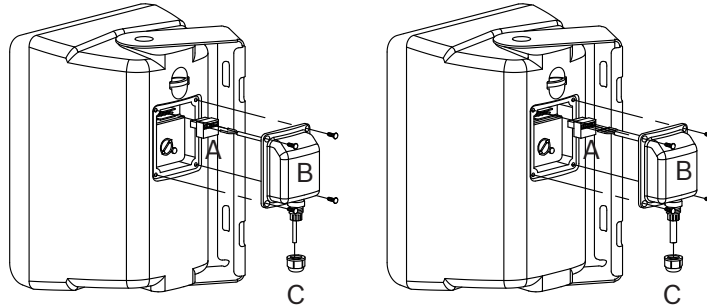

3. Adjust the **tap settings**, if needed.
4. Mount the **speaker**, as shown in the installation section.
5. Plug the **Euroblock connector** into the speaker.
6. Insert the **four screws** into the weather cover (B).
Loosely tighten the four screws to keep the weather cover in place.
7. Tighten all **four screws** to secure the weather cover.
Ensure the weather cover is secure.
8. Adjust the **wire** length.
9. Tighten the **gland nut (C)**.

See also

- *Installing the speaker, page 7*

3.4 Transformer taps

You can select the mode of operation (70 V/100 V/8 ohm) and power taps using the rotary switch on the input panel.

Configuring the transformer settings

To **configure the transformer settings**, do the following:

1. Select the desired **power tap** by using the rotary switch on the input panel.

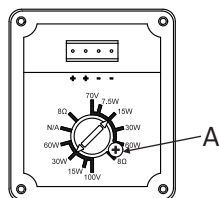

- If 8 ohm mode is desired, remove the **safety screw**.
Safety screw (A) is shown in the previous step.

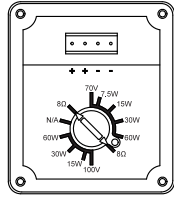

3.5 Replacing the logo

An additional logo is included, horizontal installation is shown.

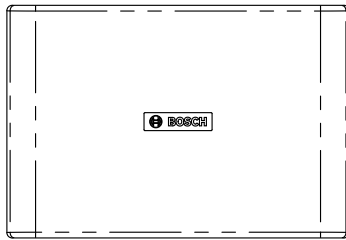

To **replace the logo**, do the following:

- Remove the existing **logo**.
- Clean the **surface** with alcohol.
- Align the **logo** with the square guide.

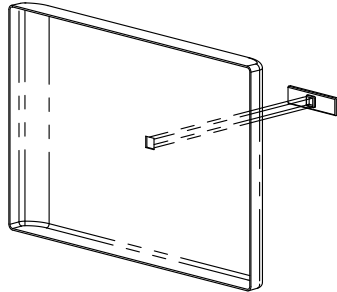

- Remove the **paper backing**.
- Insert the **logo**.
Press firmly to ensure the logo is applied.

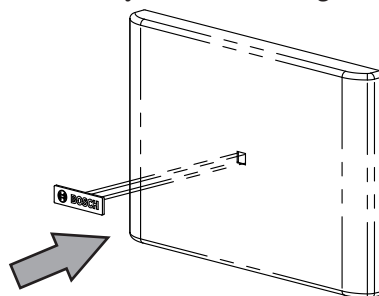

4 Troubleshooting

Problem	Possible Causes	Action
No Sound	Amplifier	Connect a known working test speaker to the amplifier outputs. If there is no sound, check all electronics are on, the signal routing is correct, the source is active; the volume is turned up, and so on. Correct/Repair/Replace as necessary. If there is sound, the problem is in the wiring.
	Wiring	Verify you have connected the correct wire pairs to the amplifier. Play something at low level through the amplifier (for example, from a CD player or tuner). Connect the test speaker in parallel with the malfunctioning line. If the sound has gone or is very weak, the line has a short in it (possibly a severe scrape, pinch, or staple puncture). If the sound level is normal the wire is open (possibly a cut wire or missed connection). Using the test speaker, move down the line and test each connection/junction until you find the problem and correct it. Observe proper polarity.
		Verify you have the inputs and outputs connected to the correct wires. If the subwoofer input panel is not correctly wired, there will be little or no sound. Observe proper polarity.
Poor Low-Frequency Response	Speakers Wired Out-of-Polarity	When two speakers are connected out of polarity (out of phase), the low frequencies will cancel each other acoustically. Carefully observe the wire markings or tracers on your speaker wires. Verify the amplifier (+) terminal is connected to the red speaker terminals and the amplifier (-) terminal is connected to the black speaker terminals.
	Improperly Wired Subwoofer Panel	Using a test speaker as described above, verify all amplifier and speaker wires are connected to their proper terminals with the correct polarity. Reversing just one set of amplifier wires can cut out all bass output from the subwoofer.
Intermittent Output such as, Crackling or Distortion	Faulty Connection	Check all connections at amplifier and speakers to ensure they are clean and tight. If the problem persists, it may be in the amplifier or wiring. See other actions above.
Constant Noise such as Buzzing, Hissing, Humming	Defective Amplifier or other Electronic Device	If the noise is present but no program material is playing, the likely cause is the signal chain in the electronics. Evaluate each component as necessary to isolate the problem.
	Poor System Grounding or Ground Loop	Check and correct the system grounding, as required.

5 Technical data

Frequency response (-3 dB):	90 Hz - 20 kHz ¹
Frequency response (-10 dB)	55 Hz - 20 kHz ¹
Sensitivity:	89 dB ²
Max SPL (calculated):	108 dB, 114 dB Peak
Coverage angle:	Horizontal 90°, Vertical 90°
Power handling:	75 W (300 W Peak) Continuous Pink Noise (100 hours)
Low Z:	Yes
Nominal impedance:	8 Ω
Minimum impedance:	6.5 Ω
Recommended high-pass:	60 Hz (24 dB/octave)
Input transformer (70 V/100 V):	60 W
Transformer taps:	70V: 60 W, 30 W, 15 W, 7.5 W, 8Ω 100V: 60 W, 30 W, 15 W, 8Ω
Low frequency transducer:	5.25 in (133 mm)
High frequency transducer:	0.75 in (20 mm)
Connectors:	Removable locking 4-pin connector (Euroblock) - (2) for connection to additional speakers in a distributed line. Max. wire size 12AWG (2.5 mm)
Environmental:	IP-65 (per IEC-60529)
Color:	Black (RAL 9004) or white (RAL 9003)
Dimensions (H x W x D):	255 mm x 180 mm x 150 mm (10.0 in x 7.1 in x 5.9 in) ³
Net weight:	3.2 kg (7.1 lb) ³
Shipping weight:	9.5 kg (21.0 lb)
Included hardware:	U-Bracket, 5-mm Allen wrench and input cover
Packaged quantity:	2

¹Half space (wall mounting).

²Half space (on wall) averaged 100 Hz – 10 kHz, 1 W.

³Without U-Bracket.

5.1 Dimensions

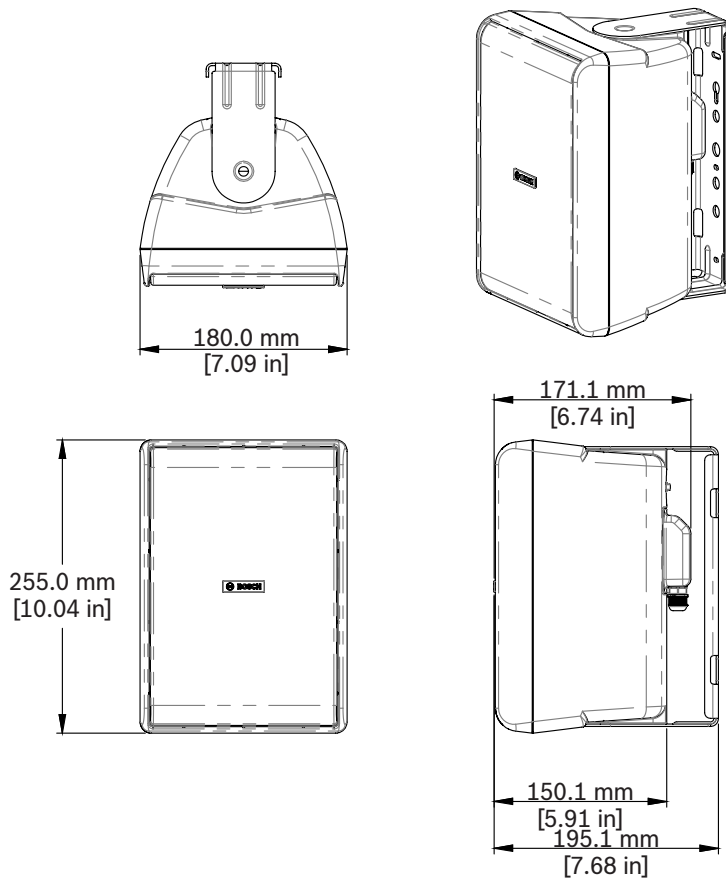

Figure 5.1: LB20-PC60EW-5 dimensions

5.2 Frequency response and impedance

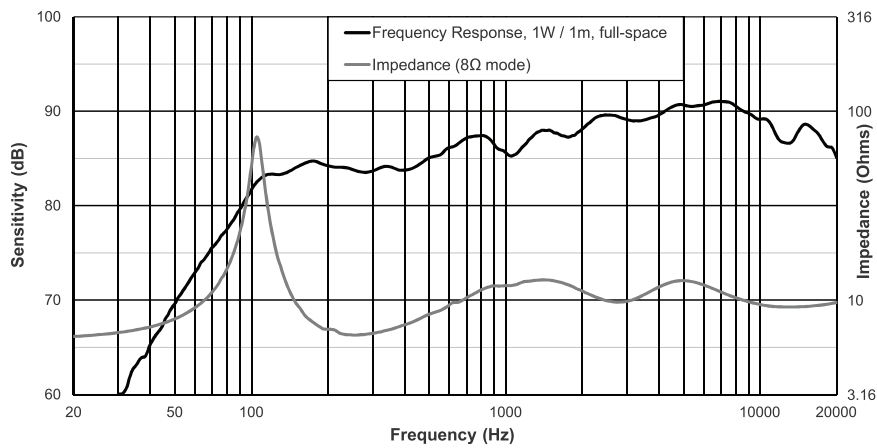
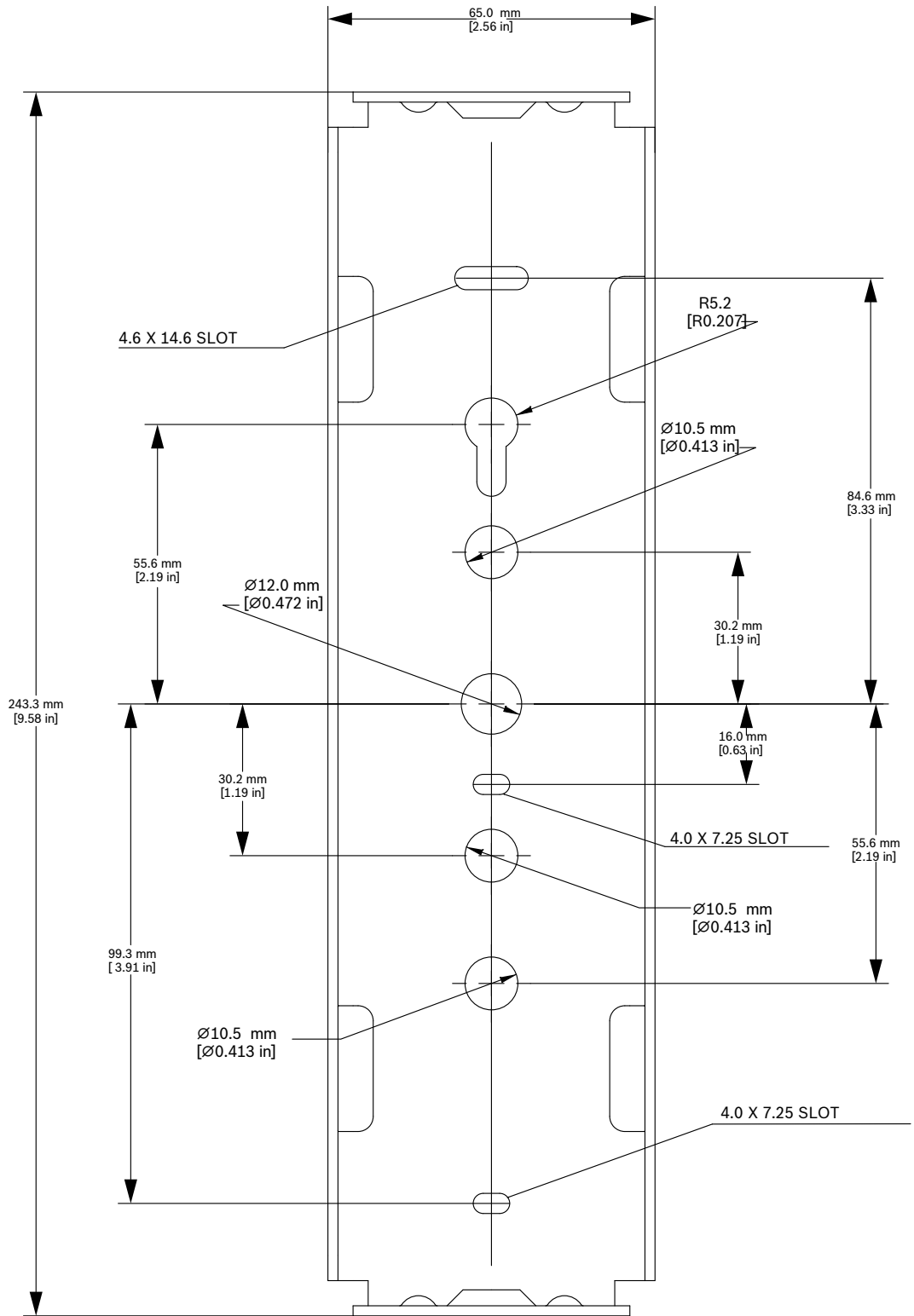

Figure 5.2: LB20-PC60EW-5 frequency response and impedance

6 U-Bracket dimensions

The U-Bracket dimensions are not to scale and are for reference only.



Bosch Security Systems B.V.

Torenallee 49

5617 BA Eindhoven

Netherlands

www.boschsecurity.com

© Bosch Security Systems B.V., 2017