

LA2-UM60-L-IN Column loudspeaker 60W, metal, white



- ▶ For applications where directivity is important
- ▶ Good speech intelligibility and background music reproduction
- ▶ Swivel wall-mounting bracket supplied as standard

The LA2-UM60-L-IN metal column loudspeaker delivers professional performance from a robust, yet aesthetically designed metal enclosure in a white finish.

It is an ideal column loudspeaker where sound beaming is required, for indoor use in passenger terminals, places of worship, conference venues, factories, exhibition areas.

A swivel wall mounting bracket is supplied as standard, allowing accurate positioning.

Installation/configuration notes

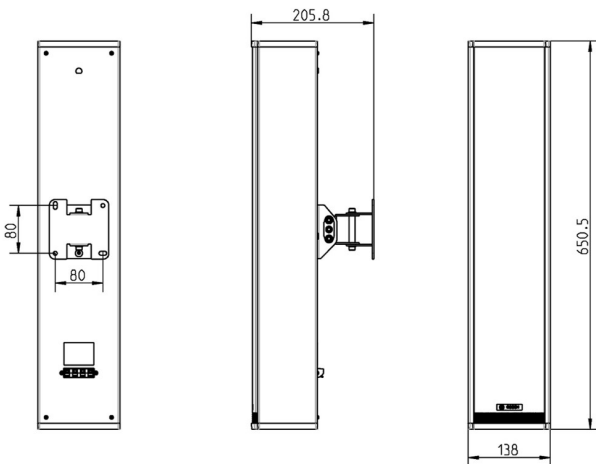

Fig. 1: Dimensions LA2-UM60-L-IN

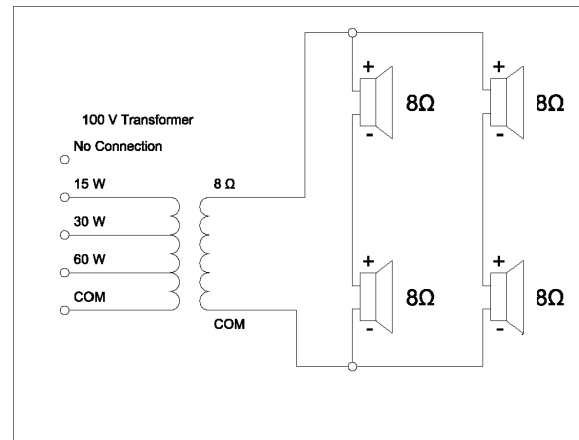

Fig. 2: Circuit diagram LA2-UM60-L-IN

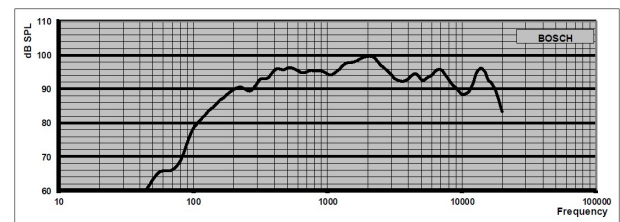

Fig. 3: Frequency response LA2-UM60-L-IN

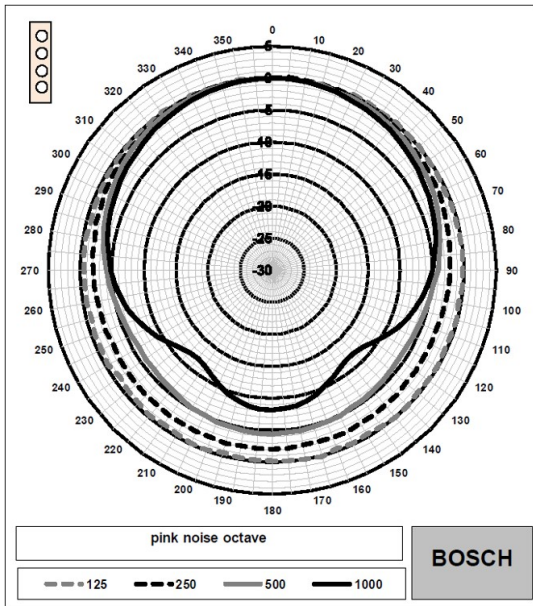

Fig. 4: Polar diagram LA2-UM60-L-IN (horizontal measured with pink noise)

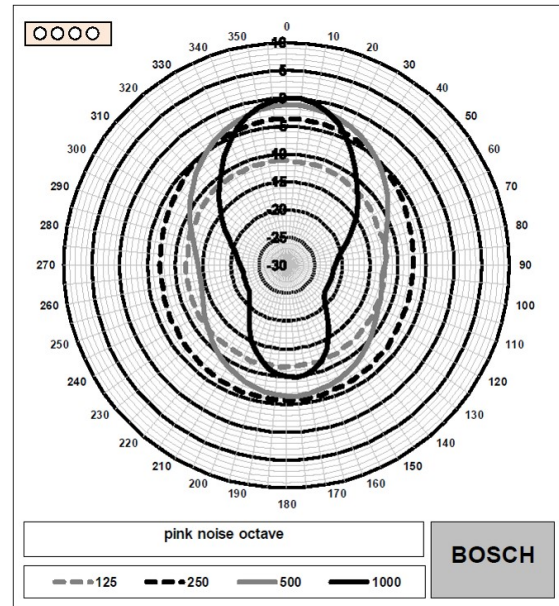

Fig. 6: Polar diagram LA2-UM60-L-IN (vertical measured with pink noise)

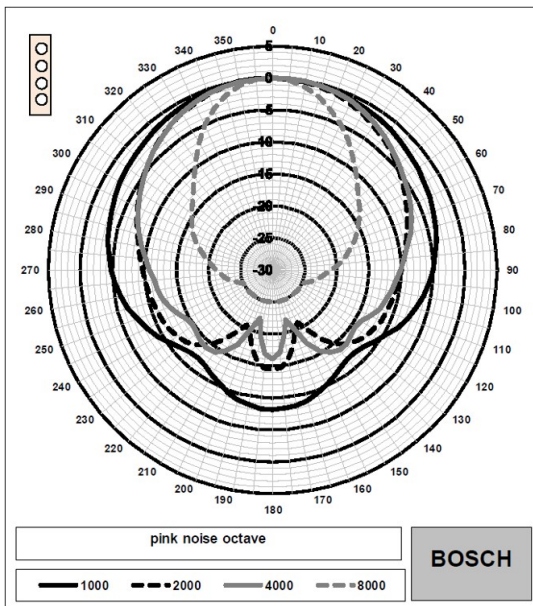

Fig. 5: Polar diagram LA2-UM60-L-IN (horizontal measured with pink noise)

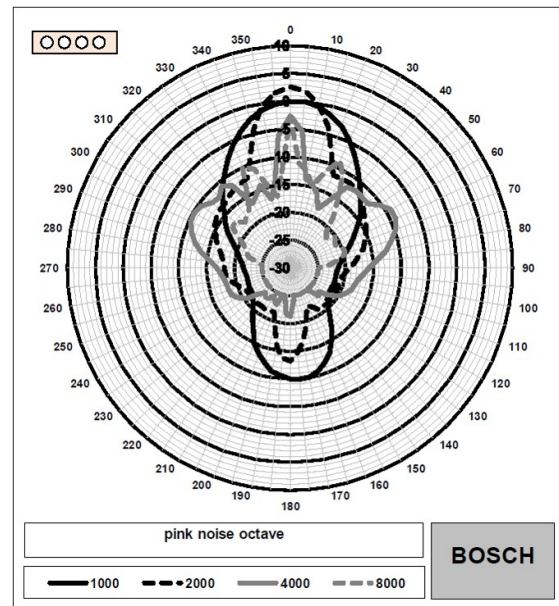

Fig. 7: Polar diagram LA2-UM60-L-IN (vertical measured with pink noise)

Parts included

Quantity	Component
1	LA2-UM60-L-IN Metal Column loudspeaker
1	Wall mounting bracket
1	Installation instruction

Technical specifications

Electrical

	LA2-UM60-L-IN
Maximum power	90 W
Rated power (PHC)	60 W
Sound pressure level at rated power / 1 W (1 kHz, 1 m)	107 / 95 dB (SPL)
Effective frequency range (-10 dB)	147 Hz to 17.4 kHz
Horizontal opening angle at 1 kHz / 4 kHz (-6 dB)	200°/ 129°
Vertical opening angle at 1 kHz / 4 kHz (-6 dB)	54°/ 14°
Rated input voltage	100 V
Rated impedance	
Full power	167 Ω
Half power	333 Ω
Quarter power	667 Ω

Mechanical

	LA2-UM60-L-IN
Dimensions (L x W x D)	651 x 140 x 110 mm (25.6 x 5.5 x 4.3 in)
Weight	8 kg (17.6 lb)
Color	Signal white RAL 9003
Material	Steel
Connection	Push terminal for speakers
Connector	1 x 4 Way Push Type

Environmental

	LA2-UM60-L-IN
Operating temperature	0 °C to +55 °C (32 °F to +131 °F)

Storage and transport temperature	-10 °C to +70 °C (-14 °F to +158 °F)
Relative humidity	≤95%

Ordering information

LA2-UM60-L-IN Column loudspeaker 60W, metal, white

Column loudspeaker 60W, metal enclosure, finished in white, supplied with a swivel wall mounting bracket. Order number **LA2-UM60-L-IN | F.01U.344.883**

Represented by:

Europe, Middle East, Africa:
 Bosch Security Systems B.V.
 P.O. Box 80002
 5600 JB Eindhoven, The Netherlands
www.boschsecurity.com/xc/en/contact/
www.boschsecurity.com

Germany:
 Bosch Sicherheitssysteme GmbH
 Robert-Bosch-Platz 1
 D-70839 Gerlingen
www.boschsecurity.com

North America:
 Bosch Security Systems, LLC
 130 Perinton Parkway
 Fairport, New York, 14450, USA
www.boschsecurity.com

Asia-Pacific:
 Robert Bosch (SEA) Pte Ltd, Security Systems
 11 Bishan Street 21
 Singapore 573943
www.boschsecurity.com/xc/en/contact/
www.boschsecurity.com