

# Radio gateway

FWI-270

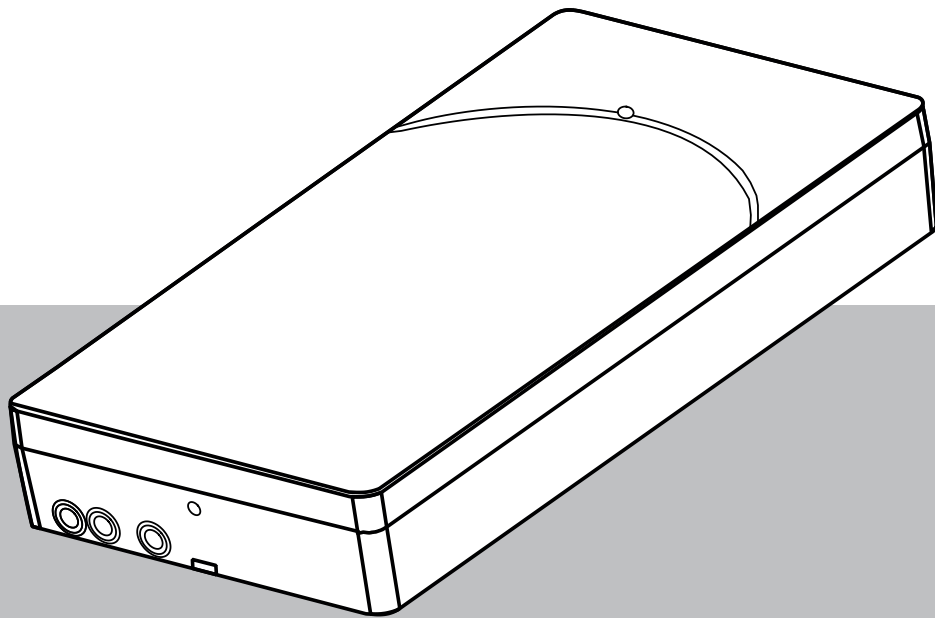



# Table of contents

<b>1</b>	<b>About this document</b>	<b>4</b>
1.1	Technical terms and abbreviations	4
<b>2</b>	<b>Safety</b>	<b>5</b>
2.1	Safety instructions	5
2.2	Safety regulations for the method of operation	6
2.3	General safety instructions	8
<b>3</b>	<b>Structure and function</b>	<b>9</b>
3.1	Setup	9
3.1.1	Radio cell	9
3.1.2	External view	10
3.1.3	Internal view	10
3.1.4	Scope of delivery	11
3.2	Function	12
3.2.1	Diagnosis levels	12
3.2.2	Status display on the radio gateway	12
3.3	Power supply	14
3.4	Accessories	14
3.4.1	Battery pack BAT3.6-10	14
3.4.2	MCL-USB (radio) adapter FDUZ227	15
<b>4</b>	<b>Planning</b>	<b>16</b>
4.1	Compatibility	16
4.2	Planning specifications	17
4.3	Planning a radio cell	19
<b>5</b>	<b>Mounting /Installation</b>	<b>27</b>
5.1	Connecting the radio gateway	29
<b>6</b>	<b>Commissioning</b>	<b>31</b>
6.1	Basic rules for commissioning	31
6.2	Commissioning the radio cell	32
<b>7</b>	<b>Maintenance / troubleshooting</b>	<b>35</b>
7.1	Establishing factory settings	35
7.2	Putting the radio cell into maintenance mode	36
7.3	Putting the radio cell into normal operation	37
7.4	Adding or removing radio devices	37
7.4.1	Adding radio devices	37
7.4.2	Removing radio devices temporarily	39
7.4.3	Removing radio devices permanently	40
7.4.4	Replacing a radio device with another of the same type	41
7.5	Replacing the radio gateway and transferring data	43
7.5.1	Replacing the radio gateway FWI-270	43
7.6	Basic principles for replacing the battery pack	44
7.7	Replacing the battery pack on the radio gateway	45
<b>8</b>	<b>Specifications</b>	<b>47</b>
8.1	Technical data	47
8.2	Dimensions	50
8.3	Master gauge for recesses	51
8.4	Environmental compatibility and disposal	51

# 1 About this document

## Goal and purpose

This document contains information on the radio gateway FWI-270. Following the instructions consistently will ensure that the product can be used safely and without any problems.

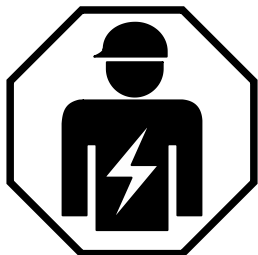

Specialist electrical engineering knowledge is required for installation.  
Only an expert is permitted to carry out installation work.  
Incorrect installation can take safety devices out of operation unbeknown to a layperson.

## Supplementary information and tips



The 'i' symbol identifies supplementary information and tips for an easier way of working.

## Intended use

The radio gateway and its specified radio devices form a wireless fire detection system. The radio gateway is intended for use with Bosch fire alarm detection systems. Other applications are not permitted.

## 1.1 Technical terms and abbreviations

Term	Explanation
LSN	Local SecurityNetwork
LSN AUX	Auxiliary power supply via AUX output of LSN 0300 A or LSN 1500 A module. Auxiliary power supply from the battery controller module (BCM-0000-B) is also possible.
MCL	Maintenance and commissioning link, interface on radio gateway to PC
LED	Light-emitting diode

## 2

## Safety

### 2.1

### Safety instructions

The safety notices must be observed in order to protect people and property.

The safety notices in this document contain the following elements:

- Symbol for danger
- Signal word
- Nature and origin of the danger
- Consequences if the danger occurs
- Measures or prohibitions for danger avoidance

#### Symbol for danger



This is the symbol for danger. It warns of **risks of injury**.  
Follow all measures identified by this symbol to avoid injury or death.

#### Additional danger symbols

These symbols indicate general dangers, the type of danger or possible consequences, measures and prohibitions, examples of which are shown in the following table:



General danger



Explosive atmosphere



Voltage/electric shock



Laser light



Battery



Heat



#### Signal word

The signal word classifies the danger as defined in the following table:

Signal word	Danger level
DANGER	DANGER identifies a dangerous situation, which <b>will result directly in death or serious injury</b> if you do not avoid this situation.
WARNING	WARNING identifies a dangerous situation, which <b>may result in death or serious injury</b> if you do not avoid this situation.
CAUTION	CAUTION identifies a dangerous situation, which could result in <b>slight to moderately serious injury</b> if you do not avoid this situation.
NOTICE	NOTICE identifies possible damage to property that may result from non-observance.

**How risk of injury is presented**

Information about the risk of injury is shown as follows:

	 WARNING
	Nature and origin of the danger Consequences if the danger occurs Measures / prohibitions for danger avoidance

**How possible damage to property is presented**

Information about possible damage to property is shown as follows:

	NOTICE
	Nature and origin of the danger Consequences if the danger occurs Measures / prohibitions for danger avoidance



**2.2**

**Safety regulations for the method of operation**

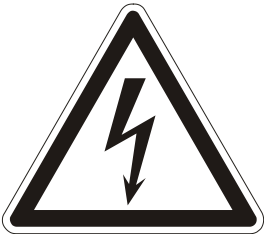

**National standards, regulations and legislation**

Bosch products are developed and produced in compliance with the relevant European and international safety standards. Should additional national or local safety standards or legislation concerning the planning, mounting, installation, operation or disposal of the product apply at the place of operation, then these must also be taken into account together with the safety regulations in the product documentation.

**Electrical installations**

	 WARNING
	Electrical voltage Electric shock Work on electrical installations may only be carried out by qualified electricians or by instructed persons working under the guidance and supervision of a qualified electrician, in accordance with the electrotechnical regulations.

Produce earthing as stated in local safety regulations.

	 CAUTION
	<p>Noncompliance with the following safety regulations            Risk of injury to persons and damage to property            Compliance with the following regulations is required.</p>

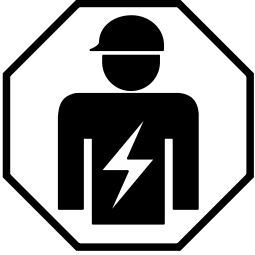
	<p>Specialist electrical engineering knowledge is required for installation.            Only an expert is permitted to carry out installation work.            Incorrect installation can take safety devices out of operation unbeknown to a layperson.</p>
---	--

### **Mounting, installation, commissioning and maintenance**

If you require tools such as a ladder, these must be safe and must be intended for the work in hand.

When starting the fire control panel ensure that unstable conditions cannot arise.

Ensure that all points listed in the 'Testing the product operability' section below are observed.

You may only set controls to normal function when the product operability has been completely tested and the system has been handed over to the customer.

### **Testing the product operability**

Prevent the remote transmission from triggering erroneously.

If testing building installations or activating devices from third-party companies, you must collaborate with the people appointed.

The activation of fire control installations for test purposes must not cause injury to anyone or damage to the building installations. The following instructions must be observed:

Use the correct potential for activation; this is generally the potential of the building installation.

Only check controls up to the interface (relay with blocking option).

Make sure that only the controls to be tested are activated.

Inform people before testing the alarm devices and allow for possible panic responses.

Inform people about any noise or mist which may be produced.

Before testing the remote transmission, inform the corresponding alarm and fault signal receiving stations.

### **Modifications to the system design and the products**

Modifications to the system and to individual products may lead to faults, malfunctioning and safety risks. Written confirmation must be obtained from Bosch and the corresponding safety bodies for modifications or additions.

### **Modules and spare parts**

Components and spare parts must comply with the technical specifications defined by Bosch. Only use products specified or recommended by Bosch

Wrong battery types and improper battery changing lead to a risk of explosion. Only use the same battery type or an equivalent battery type recommended by Bosch.

Batteries must be disposed of in an environmentally friendly manner. Observe national guidelines and regulations.

#### **Disregard of the safety regulations**

Before they are delivered, Bosch products are tested to ensure they function correctly when used properly. Bosch disclaims all liability for damage or injuries caused by the incorrect application of the instructions or the disregard of danger warnings contained in the documentation. This applies in particular to the following damage:

- Personal injuries or damage to property caused by improper use and incorrect application.
- Personal injuries or damage to property caused by disregarding safety instructions in the documentation or on the product.
- Personal injury or damage to property caused by poor maintenance or lack of maintenance.

## 2.3 General safety instructions



#### **Danger!**

Remove the auxiliary power supply if you want to connect FDUZ227 MCL-USB adapter radio to the gateway!



#### **Caution!**

Electrostatic discharge (ESD)! Electronic components could be damaged. Ground yourself using a wrist strap or take other suitable actions.



#### **Caution!**

Use only the lithium battery pack as specified in the accessories (order number **BAT3.6-10**).



#### **Notice!**

Batteries are not included in the scope of delivery. A battery pack is always needed to commission and operate the radio gateway.



#### **Notice!**

Electrical data for the built-in short circuit isolator according to EN 54-17:2005, you find in F.01U.003.287 FLM-I 420-S Installation Guide.



#### **Notice!**

Ensure that your operating system is up-to-date (updates, patches, firewall etc.) when using the FXS2061-O Wireless diagnostic tool.



## 3 Structure and function

### 3.1 Setup

#### 3.1.1 Radio cell

The radio gateway forms a radio cell together with the radio devices that are connected via radio.

The radio gateway is used to monitor signals from radio devices and transfer them to a fire control panel via the LSN line.

The radio gateway communicates with the control panel via the LSN line. Power is supplied via AUX power supply and via a battery pack. This ensures a permanent power supply for the radio gateway.

The areas that radio cells cover may overlap. The radio cell may occupy a maximum of 31 LSN addresses (30 addresses for radio devices and 1 address for the radio gateway).



Observe the country-specific regulations relating to the permitted number of devices. The radio gateway always occupies one address.

The radio gateway FWI-270 can communicate with the following devices:

- Radio fire detector FDOOT271-O
- Radio manual call point FDM273-O
- Radio manual call point FDM275-O

The following diagram shows possible ways of integrating the radio gateway into the fire detection system on a LSN line.

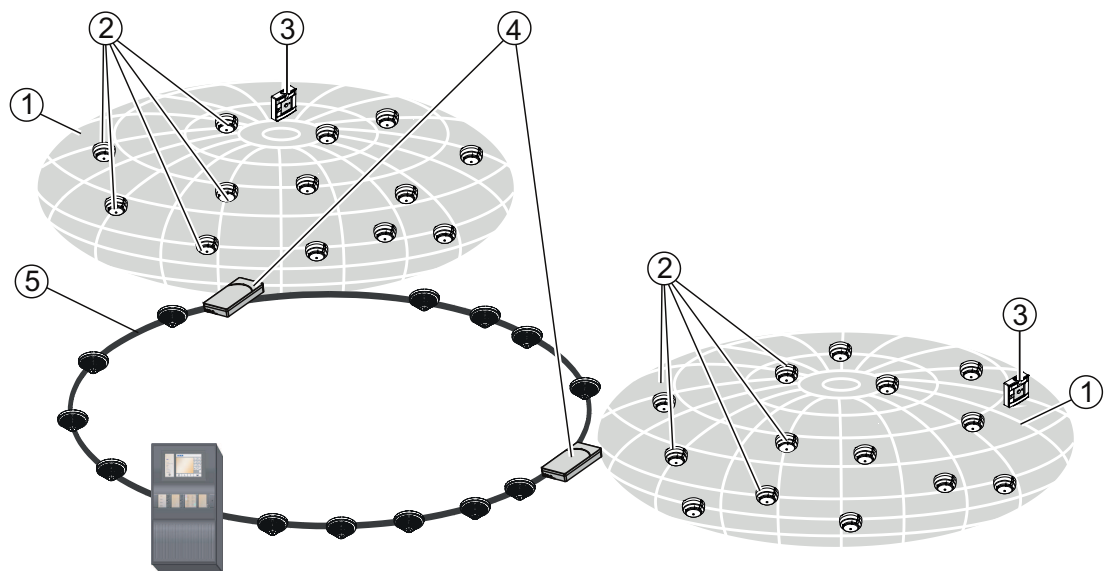

**Figure 3.1:** FWI-270 on a LSN loop

1	Radio cell	4	Radio gateway FWI-270
2	Radio fire detector FDOOT271-O	5	LSN line
3	Radio manual call point FDM273-O, FDM275-O		

### 3.1.2 External view

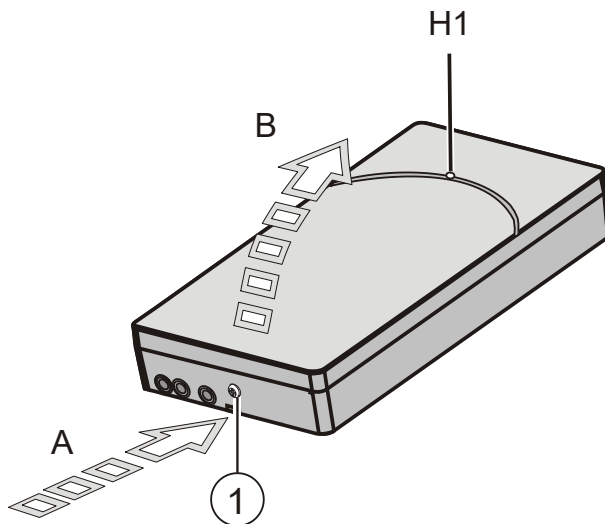
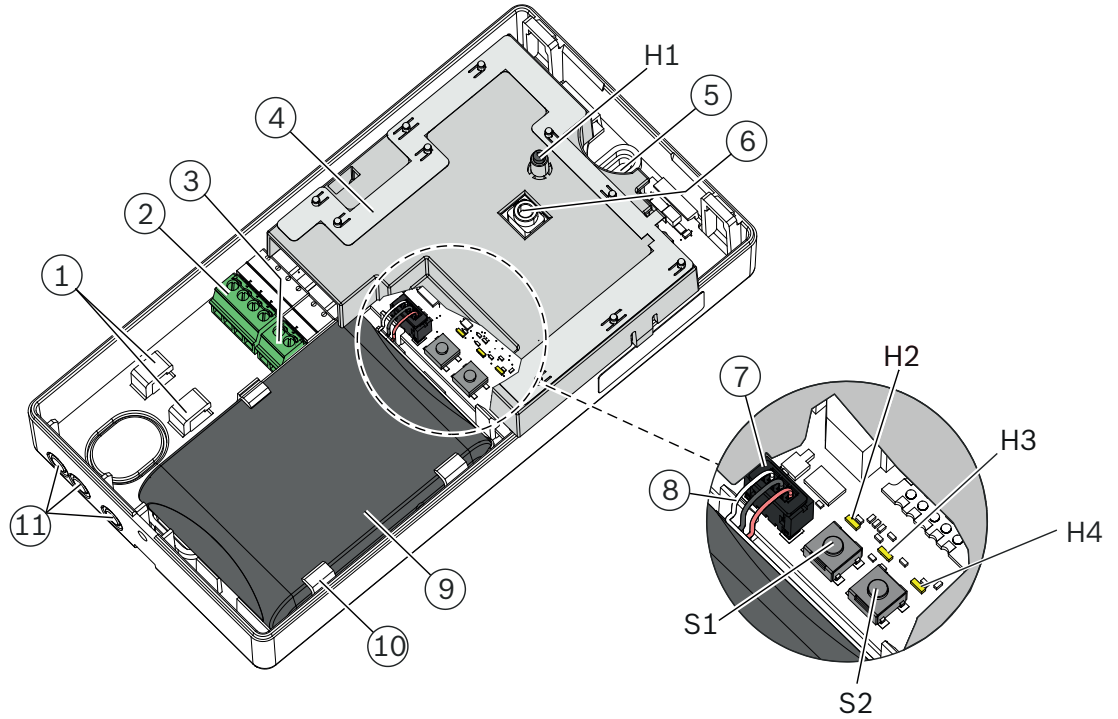

Figure 3.2: External view of FWI-270

1	Screw (Torx T7)
A	Unlocking for housing cover
B	Opening direction
H1	LED (green) for status

### 3.1.3 Internal view



**Figure 3.3:** Internal view of FWI-270

1	Fastening tabs for strain relief	11	Cable entries
2	Terminal block (LSN line and Shield)	H1	LED (green) for status
3	Terminal block (LSN AUX power supply)	H2	LED (yellow) for maintenance mode (MC-State)
4	Aerial	H3	LED (yellow) for trouble indication (Fault/Bat)
5	Opening for screw fastening	H4	LED (yellow) for radio network (Network)
6	Socket for FDUZ227	S1	Button for maintenance mode
7	Battery connector (3-pin)	S2	Reset button
8	Battery cable		
9	Battery pack		
10	Holder for battery pack		

### 3.1.4

#### Scope of delivery

- 1x radio gateway FWI-270
- 1x screw for cover (Torx T7)
- 2x terminal block



Batteries are not included in the scope of delivery. A battery pack is always needed to commission and operate the radio gateway.

## 3.2

### Function

#### 3.2.1

##### Diagnosis levels

The radio gateway monitors its operation autonomously. If a radio gateway fails, a fault is signaled and displayed on the fire panel controller.

The following diagnosis levels are derived from the various control measurements in the radio cell:

- Battery low (notification)
- Battery critical (trouble)
- Battery missing (trouble)

Diagnosis level	Meaning	Measures
Battery low	The battery voltage is too low. Battery pack replacement recommended during the next 30 days.	Connect a new battery pack.
Battery critical	The battery is in a critical state and almost empty. Battery pack replacement needed in the next 30 hours*.	
Battery missing	The radio gateway is only being supplied with power via the auxiliary power supply. The battery is completely discharged or missing. Battery pack replacement necessary.	

\*= up to 5 years of functional integrity at standard climate. This value may vary, depending on the actual climate and the actual conditions. If the system is operated regularly or continuously at temperatures within the limit range (<15°C or >35°C), a maintenance interval of 3 years is recommended.

#### 3.2.2

##### Status display on the radio gateway

The status is displayed directly on the radio gateway by means of LEDs.

External indicator, green (H1)

Three indicators in the housing (H2, H3 , H4). You can see these if you open the housing cover.

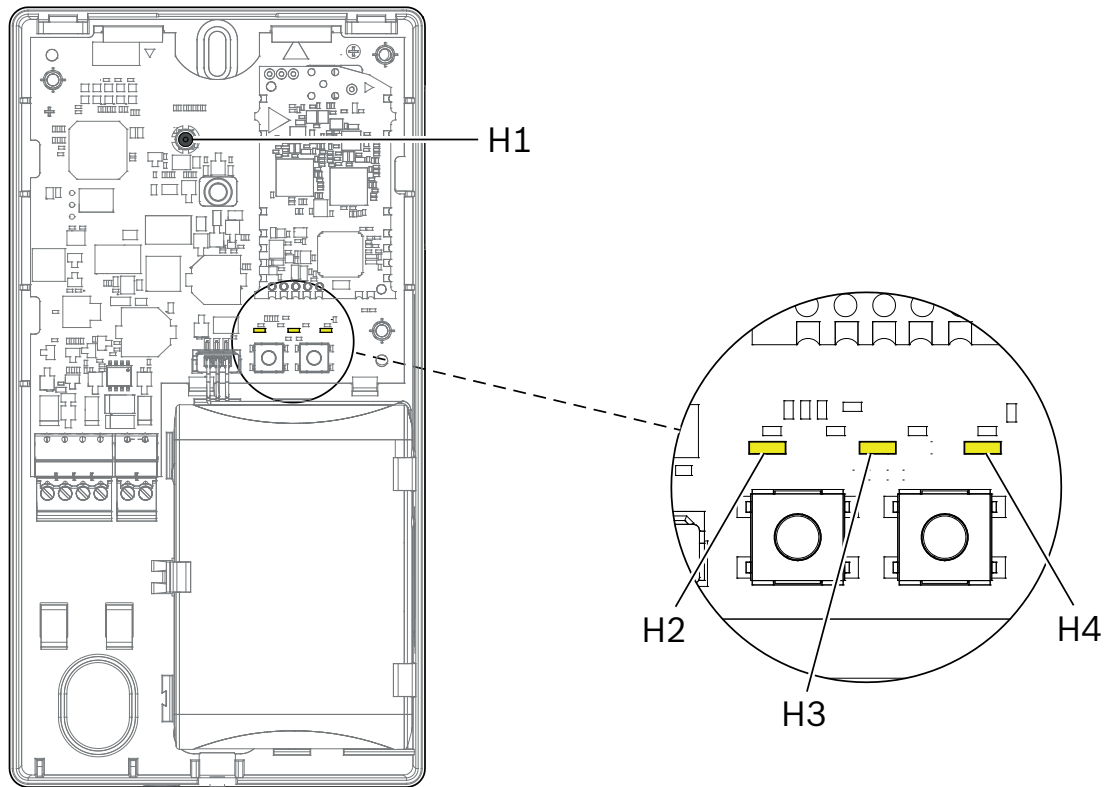

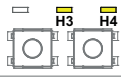
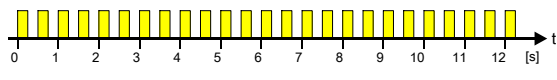
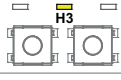
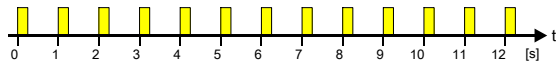
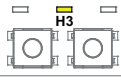

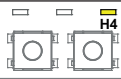

Figure 3.4: Radio gateway FWI-270

H1	LED (green) for status
H2	LED (yellow) for maintenance mode (MC-State)
H3	LED (yellow) for trouble indication (Fault/Bat)
H4	LED (yellow) for the radio network (Network)

**Radio gateway status**

The table below describes the flashing behavior of the LEDs H1...H4 for gateway FWI-270.

Indication		Meaning	Graphic
H1, H2, H3, H4	Off	When a power supply is present, the radio gateway operates without any problems.	
	H1 flashes green twice a second	Diagnostic Tool sets the localization bit.	
	H2 flashes yellow once a second	The radio cell is in maintenance mode.	

Indication	Meaning	Graphic
 <p>H3 or H3 and H4 flash yellow twice every second</p>	<p>Hardware trouble</p> <p>The radio module has failed. There is no connection to the radio devices.</p>	
 <p>H3 flashes yellow every second</p>	<p>Battery trouble (critical or missing) Battery notification (low)</p> <p>The battery pack needs to be replaced.</p>	
 <p>H3 flashes yellow every two seconds</p>	<p>Configuration trouble</p>	
 <p>H4 flashes yellow every two seconds</p>	<p>The radio cell is not yet ready for operation.</p> <p>Not all the radio devices are being monitored yet, or not all of them have been read in by the radio gateway yet.</p>	

### 3.3 Power supply

#### Power supply via the AUX supply voltage

In normal operation the gateway is powered via the LSN AUX supply voltage. Auxiliary power supply from the battery controller module (BCM-0000-B) is also possible.

#### Power supply from battery pack BAT3.6-10

	<p>When the battery pack is supplying power, the radio network remains active even if the auxiliary power supply is switched off.</p>
---	---

- For commissioning the radio cell for the first time
- If the power supply via the LSN AUX line is interrupted
- If the LSN AUX line is temporarily switched off

When the battery is full, the operating life is around one week if no power is supplied via the LSN AUX line.

### 3.4 Accessories

#### 3.4.1 Battery pack BAT3.6-10

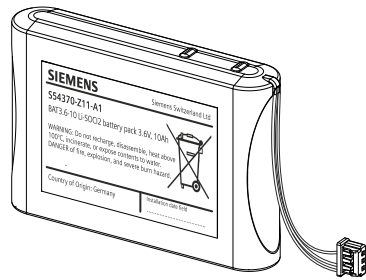

- For supplying radio devices and the radio gateway with power
- Lithium batteries
- BAT3.6-10 LI-SOCI2 battery pack 3.6 V, 10 Ah
- Batteries with battery cable
- Connector system with protection against polarity reversal
- Inscription field for commissioning date
- Compatible with:
  - Radio gateway FWI-270
  - Radio manual call point FDM273-O
  - Radio manual call point FDM275-O
  - Radio fire detector FDOOT271-O
- Order number: BAT3.6-10

### 3.4.2 MCL-USB (radio) adapter FDUZ227

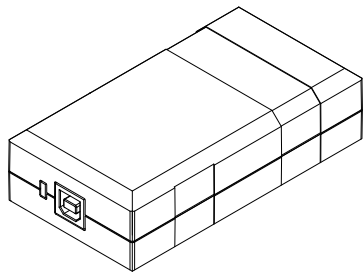

- Signals can be transmitted to radio devices via radio
- Interface converter for USB on MC link
- Compatible with:
  - Radio gateway FWI-270
  - Radio manual call point FDM273-O, FDM275-O
  - Radio fire detector FDOOT271-O
- Order number: FDUZ227

## 4 Planning

The radio connection means that there is no need to wire the radio devices, such as the radio fire detector, radio manual call point, etc., in the usual way. Together with the radio gateway, the radio devices form a radio cell.



**Notice!**

Follow the relevant national planning guidelines. If these provide that due to an error (interruption, short circuit or error having equivalent effect) occurring in a transmission path, no more than one reporting range may fail, then more than one reporting area may be assigned to a radio gateway only if it is ensured that the radio gateway is operated in a temperature range between 15°C and 25°C.

Alternatively, a radio gateway, to which more than one reporting area is assigned, can be operated with a power supply according to EN54-4, which is mounted directly next to the radio gateway. The temperature range then corresponds to the information in Chapter 8.

### 4.1 Compatibility

Compatible with fire alarm control panels that support the Local SecurityNetwork . Consider that the different LSN fire panel controller may have varying performance features, e.g. maximum number of supported LSN elements.

You will find a compatibility overview of the in the following table:

	Fire alarm panel (LSN improved)	BZ 500 LSN UGM 2020 UEZ 2000 LSN
Automatic addressing (LSN improved), T-Tap not possible	yes	no
Compatible with manual addressing	no	no
LSN classic operation, T-Tap not possible, do not use FWI-270 as first element	yes	no

Overview of the radio gateway and radio devices shown in the table below:

Radio device	
FWI-270 Radio Gateway Order number: FWI-270	

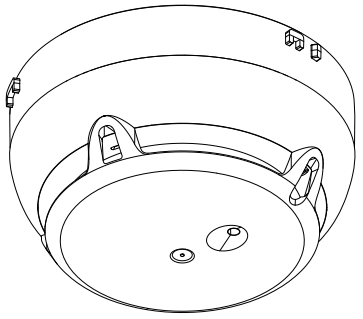
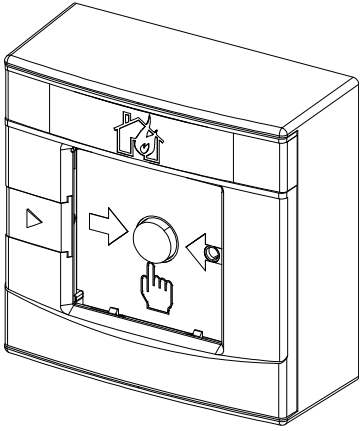
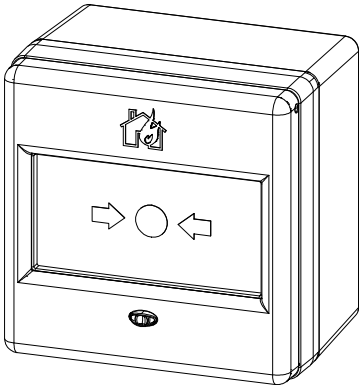

<p>FDOOT271-O Radio fire detector Order number: FDOOT271-O</p>	
<p>FDM273-O Radio manual call point Order numbers: – FDMH-273-R (housing) – FDME273-O (switching unit)</p>	
<p>FDM275-O Radio manual call point (ROW) Order number: FDM275-O</p>	

### Limitations

Maximum 10 FWI-270 radio gateways per LSN line.

Max. 30 radio devices per radio gateway. Observe national guidelines and regulations.

## 4.2 Planning specifications

The installation must be dimensioned so that the expected fire characteristics can be detected reliably.

The following planning specifications must be taken into account during planning:

- Network size
- Ranges
- Network density

	<p>The planning specifications of your system manufacturer remain unchanged. Please observe the documentation from your system manufacturer.</p>
---	--

**Network size**

Up to 30 radio devices may be connected to each radio gateway.

	<p>The maximum number of devices permitted depends on your fire control panel, national guidelines and regulations.</p>
---	---

**Range**

Range criteria:

- In buildings with small rooms and several walls, such as hotels and offices, a radio cell may be distributed over a maximum distance of 120 m.

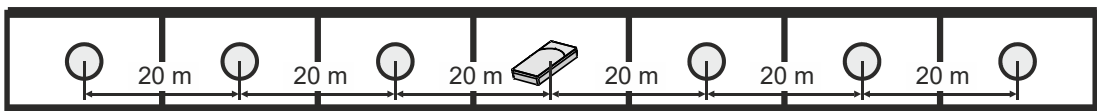

**Figure 4.1:** Radio gateways and radio devices in a multi-story building with intermediate walls

A radio link may not exceed 20 m in length. The connection to other radio devices in the same radio cell should not penetrate more than one wall.

- A radio cell may be operated over a maximum of 5 stories, with the radio gateway positioned at the middle story.

Maximum permissible distribution for cross-story planning:

		●	●	●			Floor +2	40 m
	●	●	●	●	●		Floor +1	80 m
●	●	●		●	●	●	Floor 0	120 m
	●	●	●	●	●		Floor -1	80 m
		●	●	●			Floor -2	40 m

**Figure 4.2:** Radio gateways and radio devices over five stories with intermediate walls

- In buildings without obstructions, such as large halls, a radio cell may be distributed over a maximum distance of 180 m.

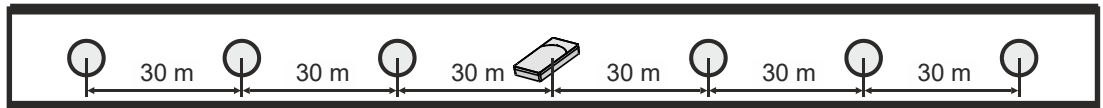

**Figure 4.3:** Radio gateways and radio devices in a multi-story building without intermediate walls

#### Network density

Each radio device can have multiple connections to its surrounding neighbors. The distance to the surrounding neighbors must be at least 1.5 m.

## 4.3

### Planning a radio cell

A floorplan must be available in order to plan a radio cell.



It is possible to plan multiple radio cells in such a way that they overlap.

#### Prerequisite

The locations of the radio devices must be selected in accordance with country-specific regulations governing automatic and non-automatic detectors.

The radio fire detection system is based on the following technological principles:

- Mesh network
- Multihop
- Multichannel operation

The combination of these three technologies makes the radio system both unique and extremely reliable.

#### Mesh network

A mesh network is a radio network linking two or more radio devices to an intermeshed network.

Characteristics:

- At least two paths between a radio device and the radio gateway
- Completely different routes; i.e., different radio links and different radio devices
- Radio devices connect to one another and configure themselves of their own accord. The network continuously modifies itself during operation

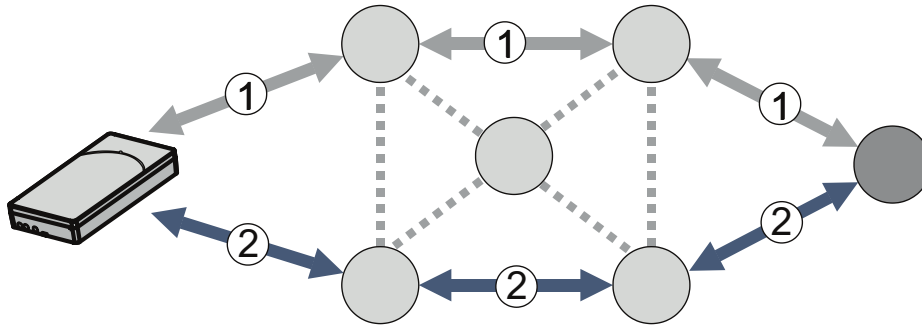

Figure 4.4: Different paths

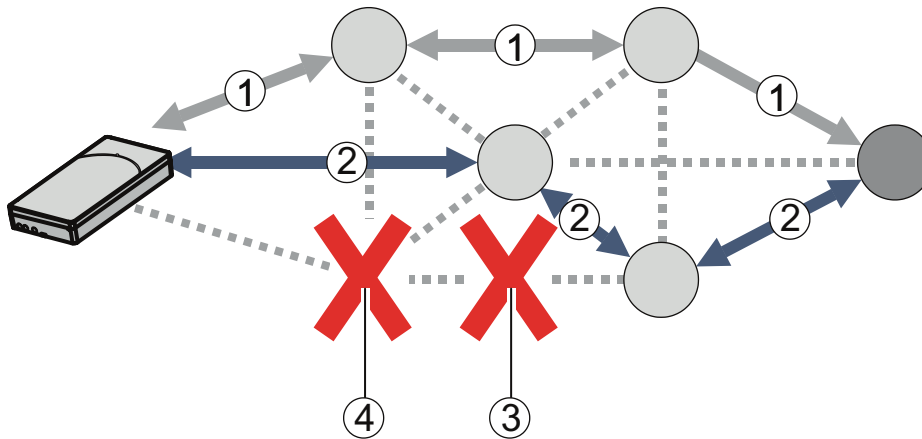

Figure 4.5: Fault

	Radio device	1	First path
	Radio gateway	2	Second path
	Radio link	3	Interruption in radio link
		4	Radio device failure

**Multihop**

Multihop technology makes it possible to extend the range in line with the number of hops. The radio link between one radio device and the next is referred to as a hop.

Characteristics:

- Each radio device has hop characteristics.
- A radio connection between a radio gateway and a radio device must take place over a maximum of three hops.

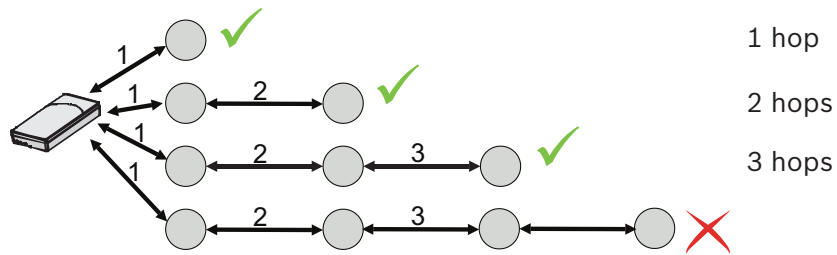

	Radio device (hop)
	Radio gateway
	Radio link

**Multichannel operation**



If a radio link repeatedly fails to work or has difficulty working, either the channel for this radio link or the frequency is changed.

Characteristics:

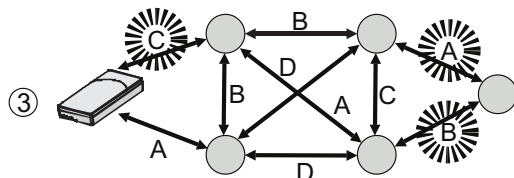
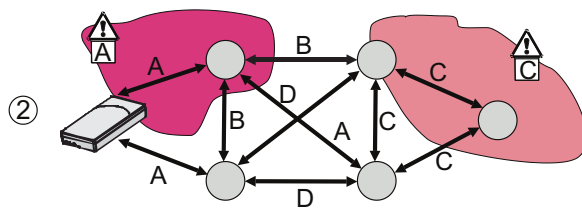
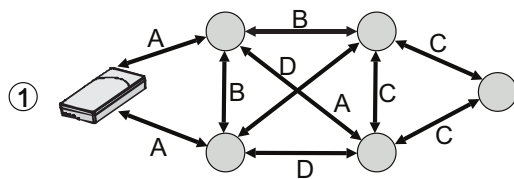
- Dual-band system with two frequency ranges
- 868...870 MHz (SRD band) with 27 channels (A, B, C, etc.)
- 433...435 MHz with 20 channels (A, B, C, etc.)
- Each radio link selects its own, independent receiving frequency.
- The two bands are given equal status.



	Radio gateway		Fault on channel 'A'
--	---------------	--	----------------------

	Radio device		Radio link
1	Radio cell without fault	2	Radio cell with faults
3	The radio cell becomes faultfree again when automatic switching to other channels takes place.		

**Positioning radio devices**

Planning must only take radio devices into consideration. If planning is being carried out for areas with wired fire detectors, these areas must be viewed as exclusion zones. For planning purposes, the following areas must be marked as exclusion zones on the floorplan:

- Areas without fire detectors, e.g., elevator shafts, wet rooms

Areas with wired fire detectors

- Walls made out of metal, extremely solid concrete walls, or damp masonry

Planning example:

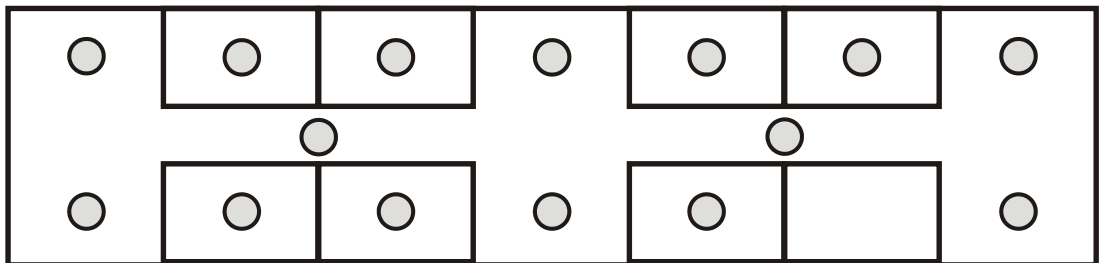

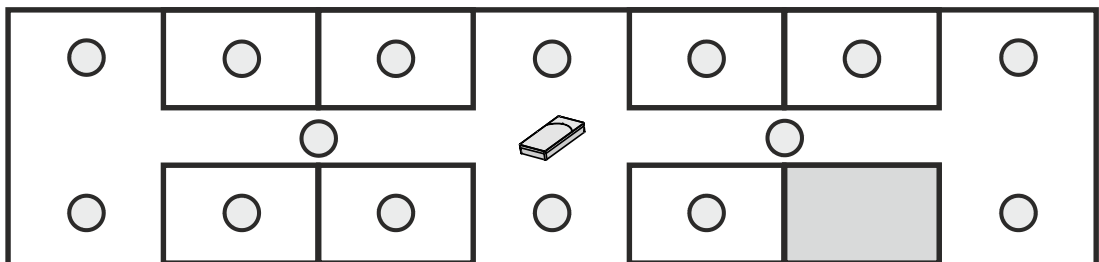

Figure 4.6: Floorplan

	For the radio fire detection system to work as well as possible, radio devices must be placed in central areas such as corridors. Include 1-2 spare radio devices in the plan for any modification work that may need to be carried out after commissioning.
---	--

**Positioning the radio gateway**

The radio gateway should be installed in a central location within the radio cell. Make sure that there are no large metal objects in the immediate vicinity of the radio gateway. These may have a negative effect on radio links.



**Checking the range**

Check the radio device ranges as indicated in the planning specifications.

1. Mark all the radio devices that are directly within the radio gateway range.

2. Using a different color, mark all the radio devices that are within the ranges of those radio devices you have already marked.
3. Using a different color again, mark all the radio devices that are within the ranges of those radio devices you have already marked.

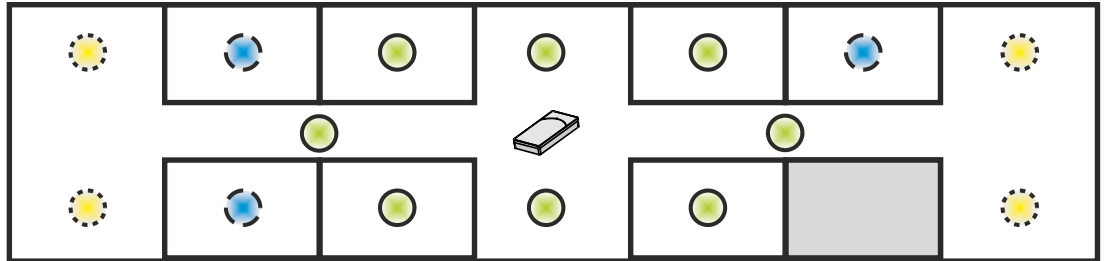

4. If a radio link passes through two walls (exclusion zone), an additional radio device must be included in the range plans.

**Checking the network density**

A network is deemed to be dense enough if each radio device is linked to at least two neighboring devices.

Steps for improving network density:

- Install additional radio devices.
- Exchange a wired fire detector for a radio fire detector.
- Move existing radio devices (taking country-specific planning guidelines into account).

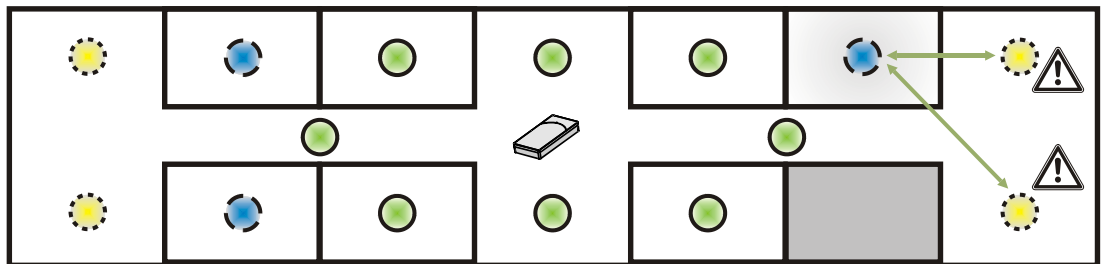

Compared with the example above, all the radio devices now have at least two neighbors.

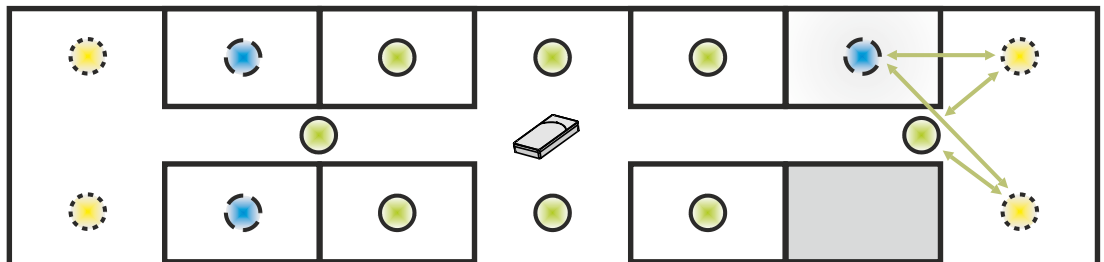

If planning is being carried out for another story, the network density can be improved using radio devices on the adjacent story.

**Multiple stories**

Proceed as follows if you are carrying out planning across stories:

- Start by planning the story on which the radio gateway is located.
- Then plan the adjacent story.
- Now mark the radio devices in accordance with the permissible ranges. You must look at the individual radio links from a cross-story perspective.

							Floor +2	40 m
							Floor +1	80 m
							Floor 0	120 m

You can use the following measures to make modifications:

- Move existing radio devices (taking country-specific planning guidelines into account).
- Install additional radio devices.
- Exchange a wired fire detector for a radio fire detector.
- Divide the radio cell into two radio cells and repeat the entire planning process from the beginning for both radio cells.

	<p>Positioning radio devices across stories improves the network density.</p>
---	---

**Topology**

- Always plan the position of the radio gateway as close to the center of the radio cell as possible. The central position allows the radio gateway to establish a connection with as many radio devices as possible.
- Avoid narrow, oblong-shaped radio cells.
- If a radio cell extends across several rooms that are separated by a corridor, then the corridor must also be fitted with radio fire detectors. This is often required in hotels and nursing homes. If the corridor cannot be fitted with radio fire detectors, adapt the radio cell according to the topology of the rooms.



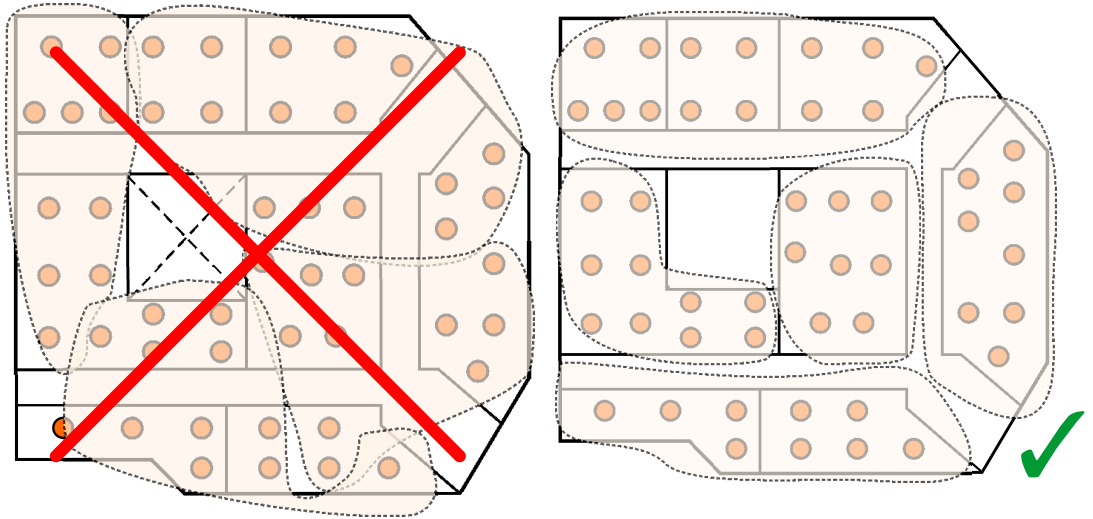

- Do not combine existing wired point detectors in the corridor with radio cells in rooms. The distances between the radio devices are otherwise increased and additional walls make communication difficult in the radio cell.

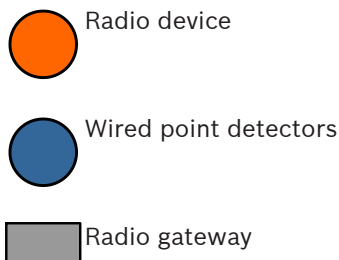
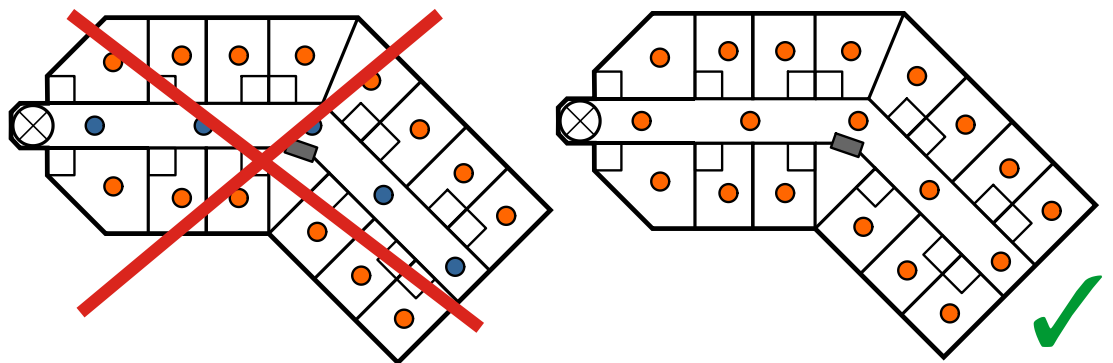

Note the following points when planning the topology. If necessary, fit the radio cell with additional radio devices, change the position of the existing radio devices or split the radio cell.

- When planning the radio cell, consider the fire safety doors and girders in the ceilings as well as the walls. Fire safety doors and girders in the ceilings can otherwise have a negative effect on the function of the radio cell.
- Carry out a critical check to ensure that the radio cells in wet rooms adhere to the regulations and conditions described in the 'Planning a radio cell' chapter.

- When planning the radio cell, always consider the elevators in the position where they could make communication difficult within the radio cell. Elevators can have a negative effect on the function of the radio cell if they are located on the same floor as the radio cell.

## 5 Mounting /Installation

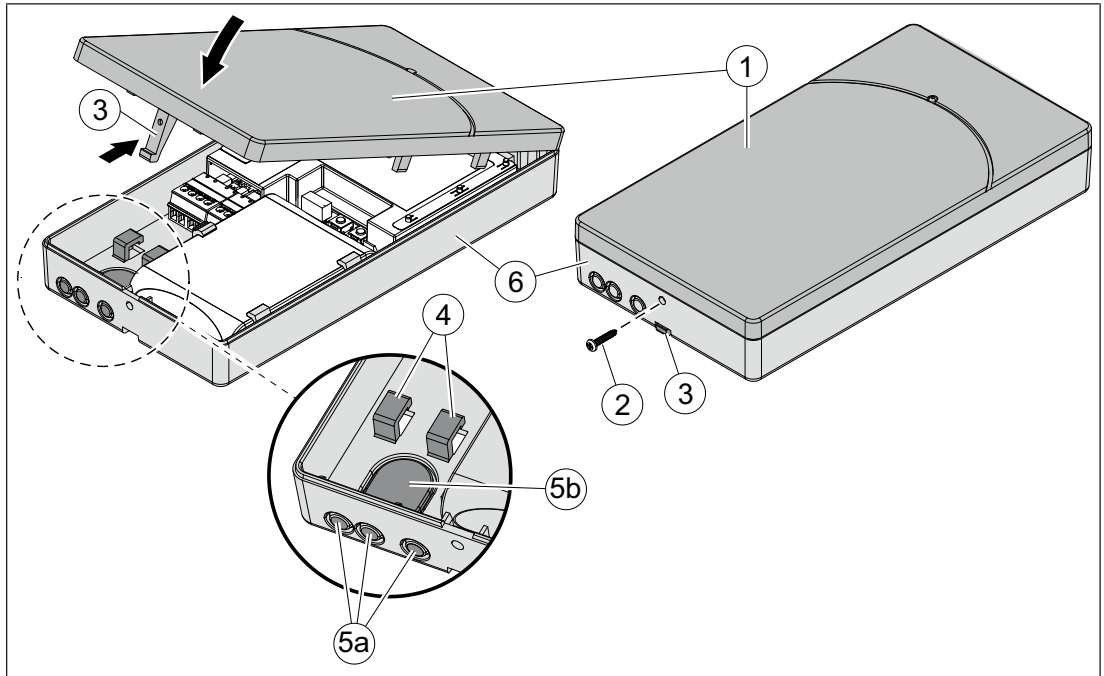

1	Housing cover
2	Screw (Torx T7)
3	Lock
4	Strain relief fastenings
5	Cable entries
6	Back box

### Mounting the radio gateway

- ▷ Radio gateway, battery pack, fixing screws, and cable tie are at hand.
  - ▷ You have the device location plan at hand.
  - ▷ The connection cable has a conductor cross-section of 0.2...1.5 mm<sup>2</sup>.
  - ▷ The lines to the installation location are installed.
  - ▷ Two fixing screws (Ø max. 3.6 mm) are at hand.
1. Determine the installation location:
    - The housing must be positioned in accordance with the planning specifications (make sure there is a wide radio range and that the housing can be accessed easily).
    - Make sure there is enough space for you to open the housing cover easily.
    - The housing may be installed in any appropriate position.
  2. Take the adhesive label bearing the serial number from the accessory bag and use it to mark the installation location on the device location plan.
  3. In the back box (6), break out the plastic for the cable entry:
    - Openings in the supporting surface for flush-mounted cables (5a)
    - Openings in the narrow side for surface-mounted cables (5b)
  4. Insert the cables into the back box (6).

- Mount the back box (6), without the battery pack, on a flat surface using two screws ( $\emptyset$  max. 3.6 mm) at the mounting points. One screw at the mounting point is sufficient for fixing in housing.

### Wiring the radio gateway

The radio gateway is mounted.

The lines to the installation location are installed.

Two cable ties (width max. 4.6 mm) are at hand.

A 2.5 mm slotted screwdriver is at hand.

- Strip each connection cable by around 40 mm and each wire by around 7 mm.
- Insert the connection cables into the back box.
- Connect the connection cables to the terminal blocks with the slotted screwdriver.
- Connect the terminal blocks to the radio gateway.
- Fasten the connection cables using the cable ties as strain relief (4).
- Label the battery pack with the date.
- Insert the battery pack and align the position of the battery cable to the battery connector.



### Notice!

Do not connect the battery pack until you are ready to commission the radio cell.

To close the housing:

- Position the housing cover (1) on the top edge of the back box (6).
  - Using a screwdriver to press the lock (3) into the housing and close the housing cover (1).
  - Tighten the screw (2) with a Torx T7 screwdriver.
- ✓ The gateway is closed.

For opening the housing, the above steps are carried out in reverse order.

### Terminal connection

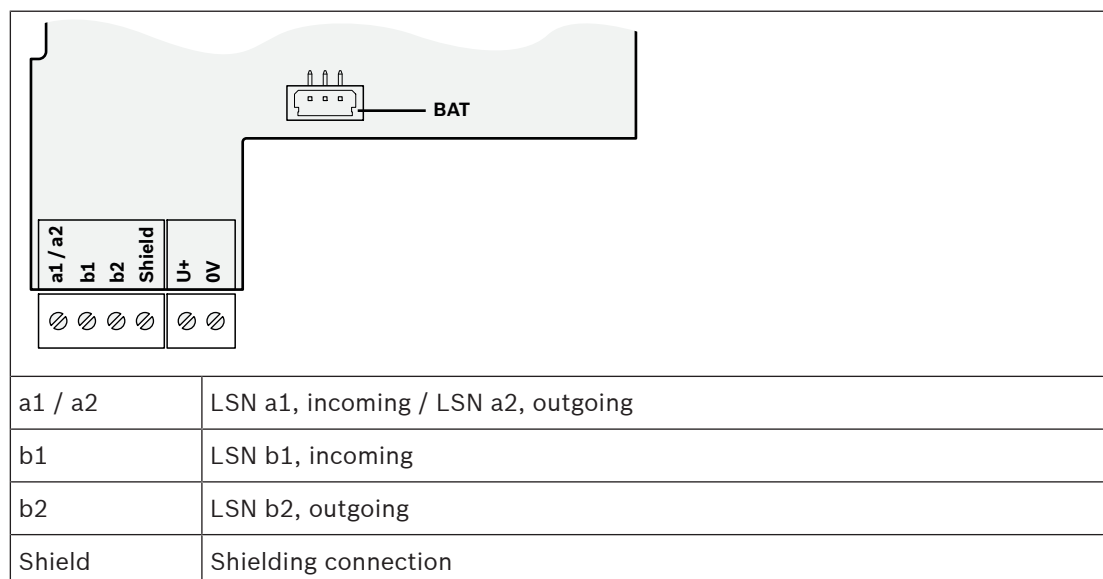



U+, 0V	Auxiliary power supply
BAT	Battery connector

**Refer to**

- *Master gauge for recesses, page 51*
- *Connecting the radio gateway, page 29*

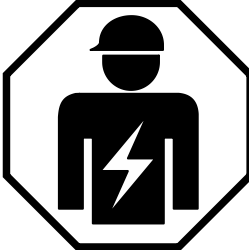
**5.1****Connecting the radio gateway**

	<p>Specialist electrical engineering knowledge is required for installation.</p> <p>Only an expert is permitted to carry out installation work. Incorrect installation can take safety devices out of operation unbeknown to a layperson.</p>
---	---

	<p>NOTICE</p> <p>Failure of the electrical connection</p> <p>Damage to the screw terminals or contact problems may lead to faults in the electrical connection. If the conductor cross-sections you want to connect to the radio gateway are larger than 1.5 mm<sup>2</sup>, the screw terminals may become damaged or contact problems may arise.</p>
--	--

Once all the radio devices of a radio cell have been logged on to the radio gateway (B) in battery mode (A), the radio gateway can be connected to the LSN line and auxiliary power supply (C).

The radio cell can be setup in the battery mode as shown in following graphic or can be set up by using the auxiliary power (LSN AUX) or BCM (24V).

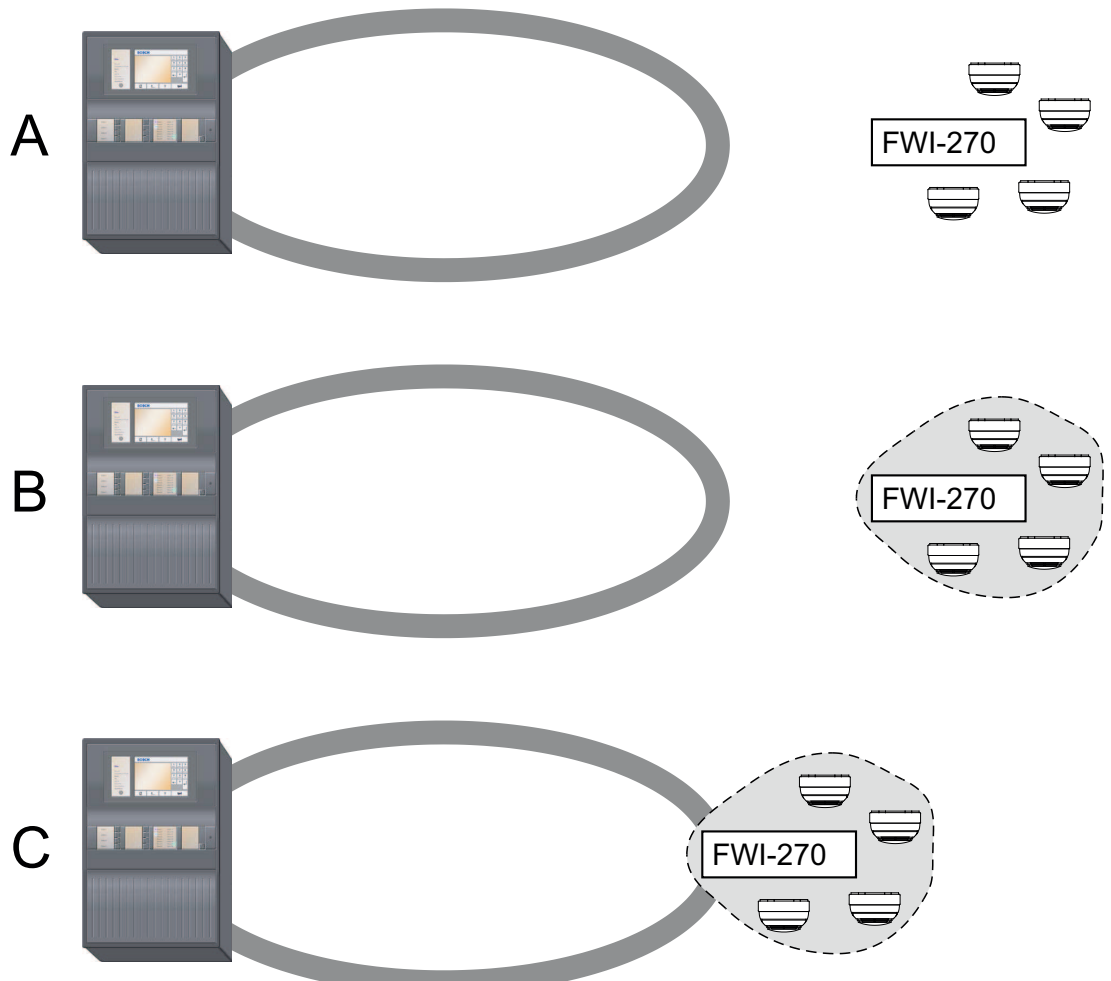

**Figure 5.1:** Connecting the radio cell to the LSN line and auxiliary power supply

## 6 Commissioning

There are two operating conditions for radio cells.

### Normal operation

The radio cell is active and ready for use. Information is transmitted to the LSN line via the radio gateway.

### Maintenance mode

The radio cell is active but not ready for use. Information is not transmitted to the LSN line via the radio gateway. The radio cell can be modified.

### 6.1 Basic rules for commissioning

Requirements for reliable radio device connections:

- Radio cells whose areas of coverage overlap must not be in maintenance mode at the same time. This means that you should only ever switch one radio cell at a time to maintenance mode.

#### Sequence for commissioning radio devices

Working outwards from the radio gateway, commission the individual radio devices one after the other. The graphic below serves as an example of the correct sequence for commissioning radio devices.

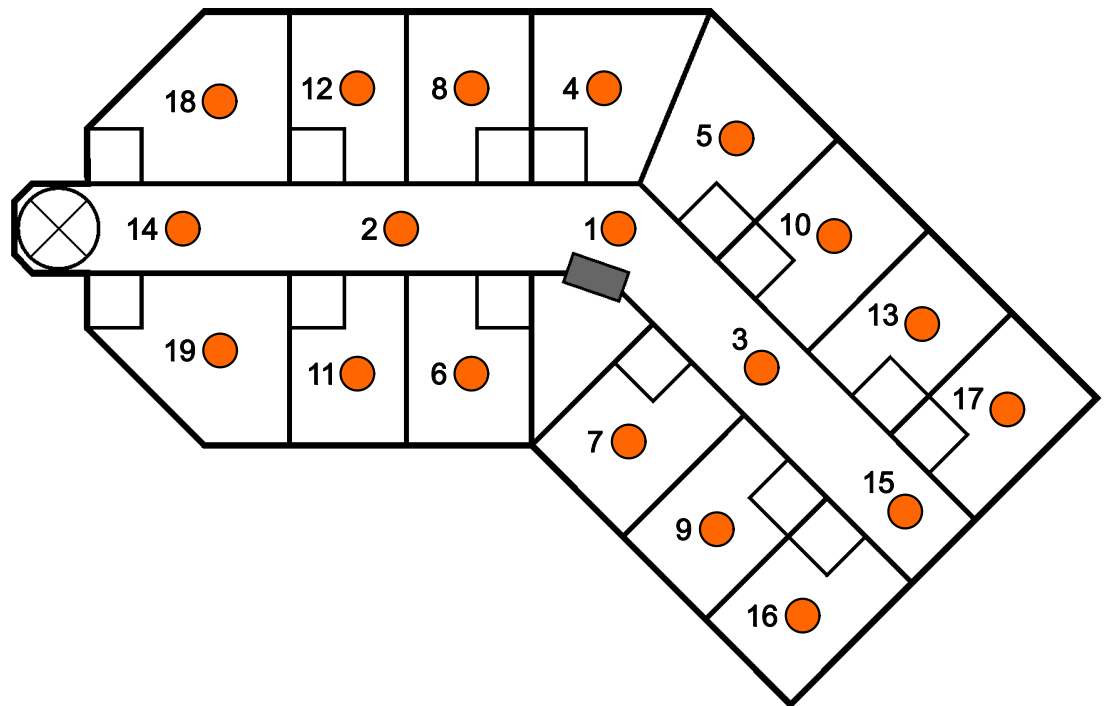
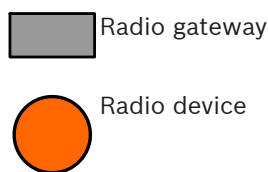

Figure 6.1: Example: Correct sequence for commissioning radio devices



	<p>Commission the radio devices that are close to the radio gateway first. Commission the radio devices that are furthest away from the radio gateway last.</p>
--	---

	<p>Only commission the radio cell at the installation location.</p>
--	---

## 6.2 Commissioning the radio cell

The radio gateway forms a radio cell with the radio devices that are connected. The radio cell is switched to maintenance mode along with the radio gateway. To ensure that radio devices are integrated into the correct radio gateway, only one radio gateway may be in maintenance mode at any given time.

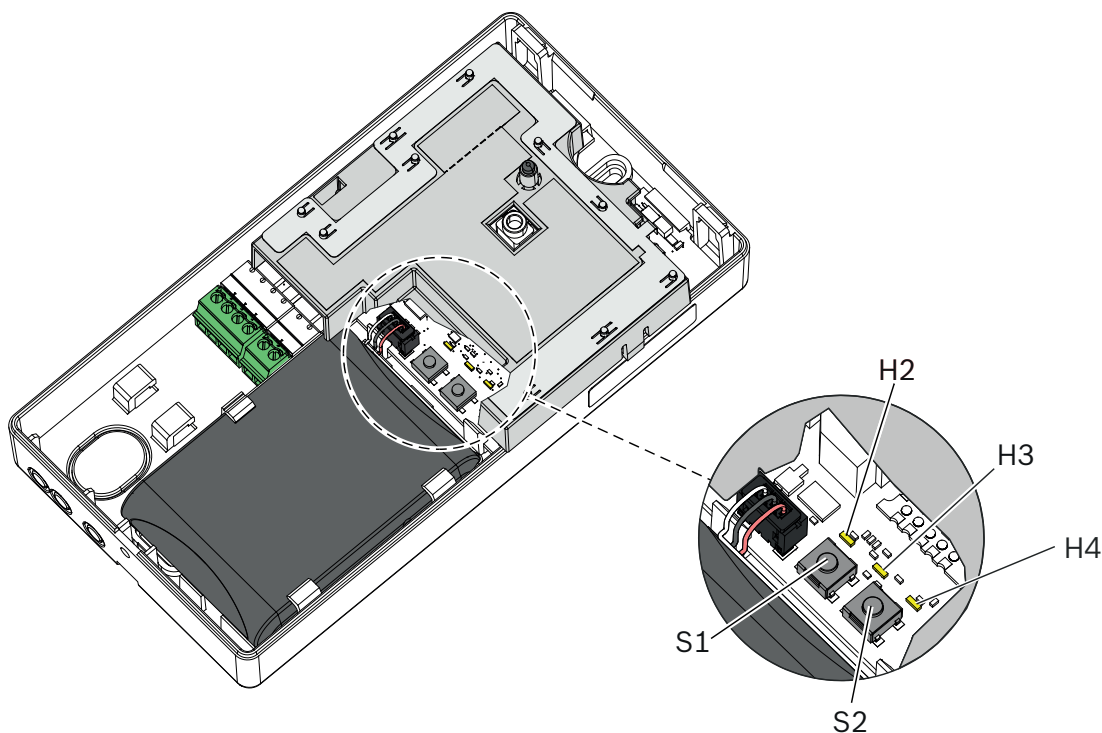

Figure 6.2: Radio gateway FWI-270



H2	LED (yellow) for maintenance mode (MC-State)	S1	Button for maintenance mode
H3	LED (yellow) for trouble indication (Fault/Bat)	S2	Reset button
H4	LED (yellow) for radio network (Network)		

### Set up the radio cell

The radio gateway is at hand or installed.

The radio detector bases and the radio manual call point housings are mounted.

The radio devices are at hand.

The device location plan is at hand.

Fresh battery packs of type BAT3.6-10 for the radio gateway and the radio devices are at hand.

A permanent marker is at hand

The technical manuals for the radio devices are at hand.

1. Open the radio gateway housing.
2. Use the permanent marker to label the new battery pack with the current date.
3. Insert the battery pack and connect it to the radio gateway.
4. Press button (S2) for at least 2 seconds and, at the same time, connect the battery connector.

The radio gateway performs a reset.

The radio gateway is now ready for operation.

5. Press and hold button (S1) for at least 2 seconds until LED (H2) flashes.

The radio gateway and its radio cell are in maintenance mode.

LED (H2) flashes at 1-second intervals.

The radio devices can now be logged on.

6. Working outwards from the radio gateway, commission the individual radio devices one after the other.

Remove the adhesive label from the radio device and use it to mark the installation location on the device location plan.

1. Connect the power supply for the radio device.  
The internal alarm indicator of the radio device flashes.  
If it flashes red, this indicates the factory settings.  
Green flashing indicates that the radio device has already been logged on to a radio gateway and needs to be set to the factory settings.
2. To set a radio device to the factory settings, press the 'new' button on the radio device until the internal alarm indicator flashes red.  
The radio device is set to the factory settings.
3. Mount the radio device in the appropriate base (FDOOT271-O) or in the appropriate housing (FDM273) or back box (FDM275-O).  
The search for the radio network starts. During the search, the internal alarm indicator briefly flashes green twice, at an interval of 2 seconds.  
Once the radio device has successfully been logged on to the radio gateway, the network search stops and the internal alarm indicator goes out.
4. If the logon process has not been successful after a long period of time has passed, briefly remove the radio device from the base/housing and then re-insert it.  
The search for the radio network starts again.

5. Follow the same steps to log on the next radio device.  
All the radio devices are now logged on and form a radio cell.
  6. Wait until LED (H4) on the radio gateway goes out.
  7. Check that the number of logged-on radio devices in the radio cell is complete.  
Check that the internal alarm indicators of all the radio devices are off.
1. To switch the radio cell to normal operation, press and hold button (S1) for at least 2 seconds.
  2. Wait until the LED (H2) goes out.  
The radio cell is in normal operation.
  3. If the radio gateway is not yet connected to the fire panel disconnect the battery of the radio gateway.
- ✓ All the radio devices have now been read in at the fire control panel.
  - ▶ Use the FXS2061 to back up the network file. The procedure for backing up the network file is described in more detail in the User Guide FXS2061.

### Commissioning the radio gateway

The radio gateway is installed.

The radio gateway is connected to the fire panel.

A computer with FSP-5000-RPS installation is at hand and connected to the fire panel.

The user is familiar with the corresponding fire panel documentation.

1. Start RPS on your computer.
  2. Open a configuration file and configure the radio gateway:
    - Automatically by auto-detection from the node or LSN module context menu
    - Manually by adding it to the LSN module at its correct physical position
1. Download the configuration to the fire panel.
  2. Wait for the fire panel to restart.
- ✓ The radio gateway is commissioned

### Commissioning the radio cell

The radio gateway is commissioned.

The radio gateway battery is connected.

The radio cell is set up.

A computer with the latest FSP-5000-RPS programming software installation is at hand and connected to the fire panel.

The user is familiar with the corresponding fire panel documentation.

1. Start FSP-5000-RPS on your computer.
  2. Open a configuration file and configure the radio cell:
    - Automatically: by auto-detect radio devices from the radio gateway context menu
    - Manually: by adding the radio devices to the radio gateway and entering their correct ID numbers
  3. Download the configuration to the fire panel.
  4. Wait for the fire panel to restart.
- ✓ The radio cell is commissioned

### Refer to

- *Basic rules for commissioning, page 31*
- *Replacing the battery pack on the radio gateway, page 45*

# 7 Maintenance / troubleshooting

Maintenance work on a radio cell covers:

- Adding radio devices
- Removing radio devices
- Replacing the battery pack

Requirements for performing maintenance on a radio cell:

- The radio gateway has been switched to 'maintenance mode'
- The relevant zone has been switched off at the control panel

You will find more information in the corresponding document of the control panel.

## 7.1 Establishing factory settings

	<p>All settings are deleted and reset to the factory settings!</p>
---	--

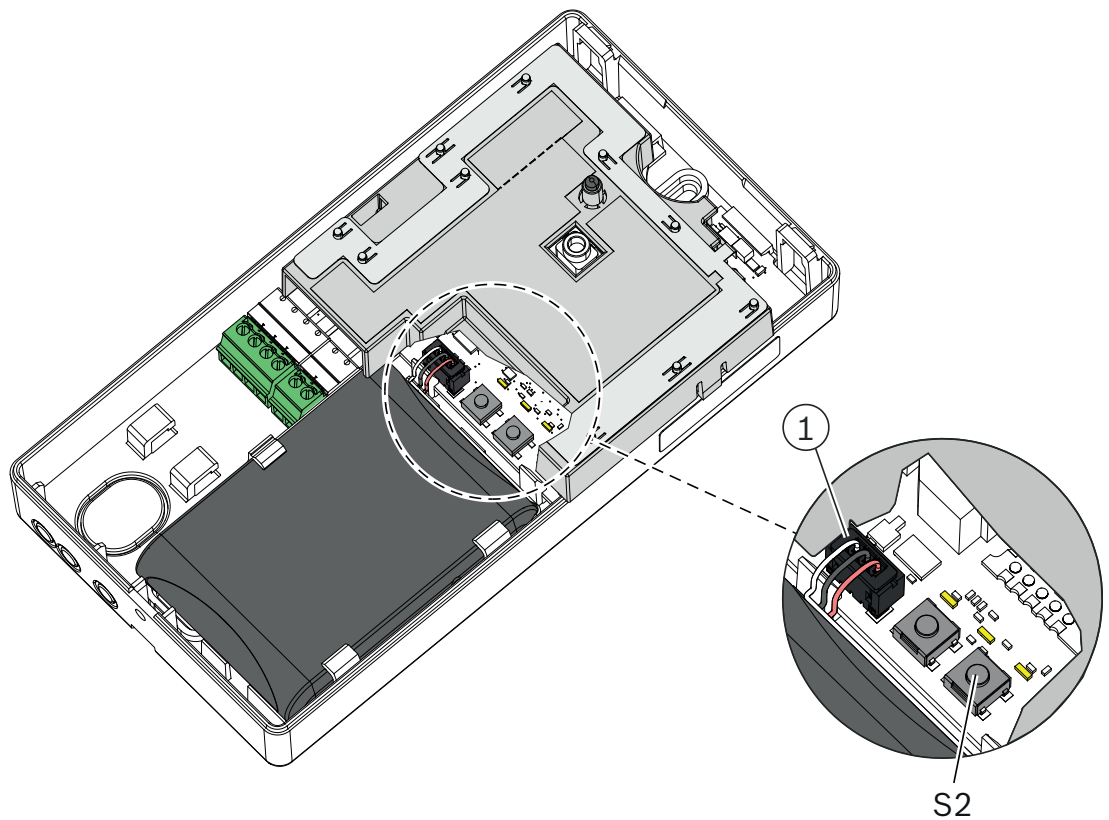

**Figure 7.1:** Radio gateway FWI-270

1	Battery connector	S2	Reset button
---	-------------------	----	--------------

Proceed as follows to restore the radio gateway to the factory settings:

The radio gateway must not be connected to the LSN line and AUX power supply.

1. Release the battery connector (1) to interrupt the power supply.
  2. Wait approx. 10 seconds.  
Any residual voltage that was present is dissipated.
  3. Press and hold button (S2).
  4. Connect the battery connector (1) to establish the power supply.
  5. Hold the button for at least 2 seconds.
  6. Release button (S2).  
After this, the radio gateway is set to the factory settings.
  7. Re-establish the other connections that have been released.
- ✓ The factory settings have been established.

## 7.2 Putting the radio cell into maintenance mode

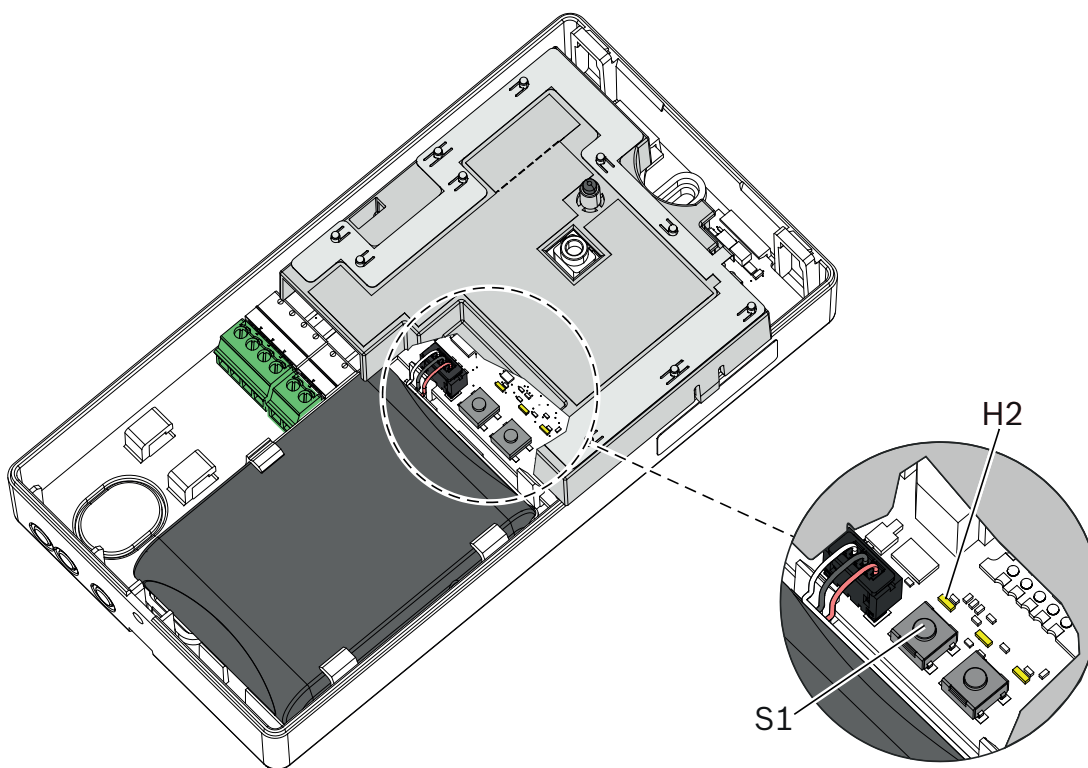

Figure 7.2: Radio gateway FWI-270

H2	LED (yellow) for maintenance mode (MC-State)
S1	Button for maintenance mode

The housing for the radio gateway is open.

The radio gateway is in normal operation.

1. Switch off the relevant zone on the fire panel controller.  
LED (H2) is not flashing.
  2. Press and hold button (S1) for at least 2 seconds until LED (H2) flashes.
- ✓ The radio gateway and its radio cell are in maintenance mode.  
 ✓ LED (H2) flashes at 1-second intervals.  
 ✓ The radio devices can now be logged on.

## 7.3 Putting the radio cell into normal operation

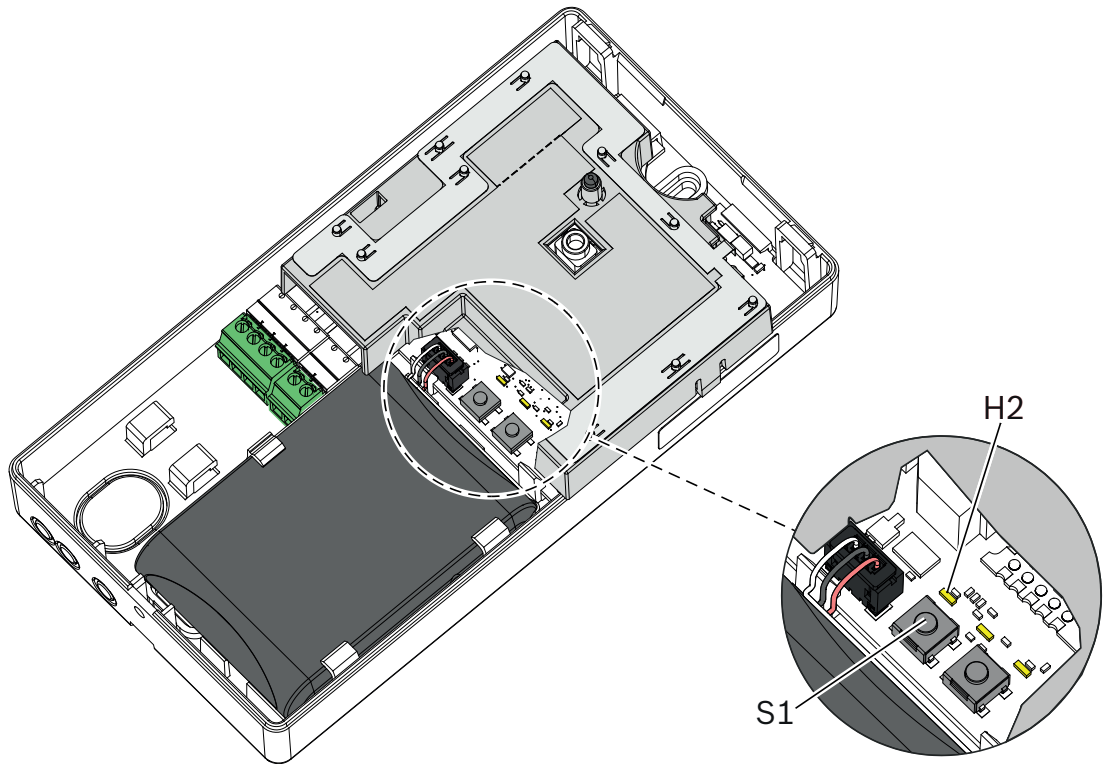

Figure 7.3: Radio gateway FWI-270

H2	LED (yellow) for maintenance mode (MC-State)
S1	Button for maintenance mode

The housing for the radio gateway is open.  
 The process of logging radio devices on to the radio gateway is complete.

1. Check LED (H2).  
 In 'maintenance mode', LED (H2) flashes.
  2. Press and hold button (S1) for at least 2 seconds.
- ✓ LED (H2) goes out.
  - ✓ The radio cell is in normal operation.

If necessary, check the panel controller settings.

## 7.4 Adding or removing radio devices

### 7.4.1 Adding radio devices

	<p>Wait until one radio device has been successfully logged on before attempting to add the next radio device. The internal alarm indicator for the radio device is off.</p>
---	--

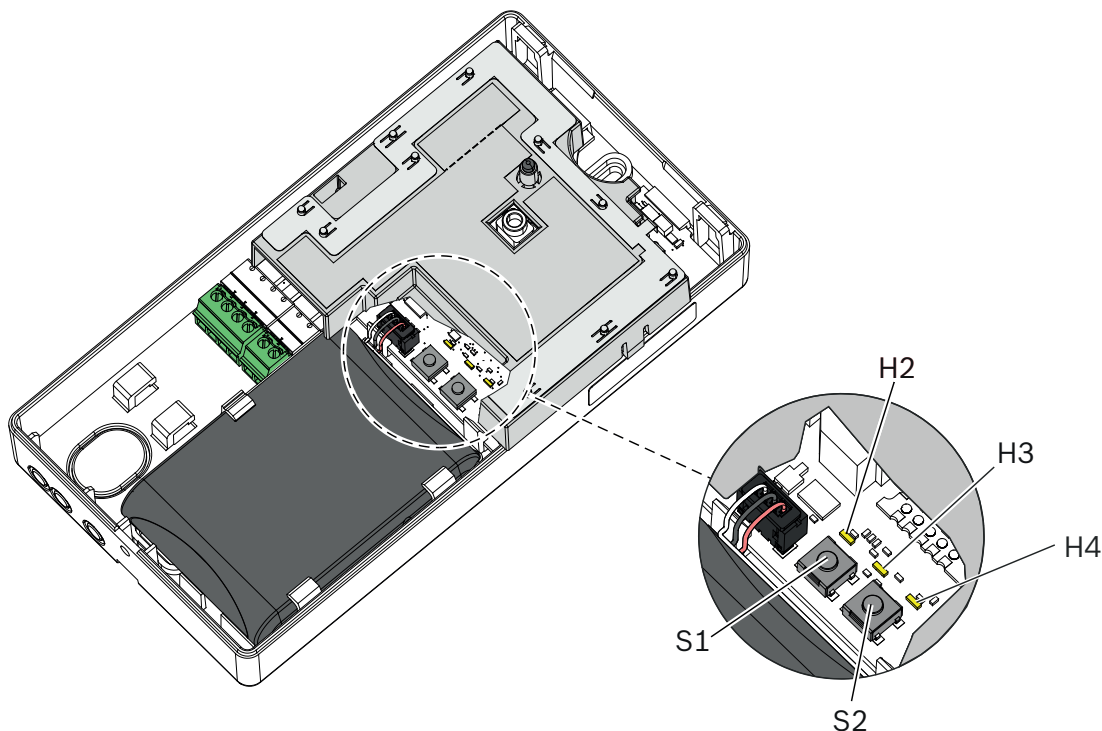

**Figure 7.4:** Radio gateway FWI-270

H2	LED (yellow) for maintenance mode (MC-State)	S1	Button for maintenance mode
H3	LED (yellow) for trouble indication (Fault/Bat)	S2	Reset button
H4	LED (yellow) for radio network (Network)		

You have the new radio device and its battery pack to hand.  
 You have a device location plan showing the locations of the radio devices in the radio cell.  
 It is possible to access the gateway and the radio devices.  
 Consider the corresponding panel controller documentation.

1. Set the radio gateway to maintenance mode.
2. Press and hold button (S1) for at least 2 seconds until LED (H2) flashes.
3. The radio gateway and its radio cell are in maintenance mode.  
 LED (H2) flashes at 1-second intervals.
4. Remove the adhesive label from the radio device and use it to mark the installation location on the device location plan.
5. Connect the power supply for the radio device.  
 The internal alarm indicator of the radio device flashes.  
 If it flashes red, this indicates the factory settings.  
 If it flashes green, this indicates that the radio device has already been logged on to a radio gateway and needs to be set to the factory settings.
6. To set a radio device to the factory settings, press the 'new' button on the radio device until the internal alarm indicator flashes red.  
 The radio device is set to the factory settings.
7. Mount the radio device in the appropriate base (FDOOT271-O) or in the appropriate housing (FDMH-273-R) or back box (FDM275-O).

The search for the radio network starts. During the search, the internal alarm indicator briefly flashes green twice, at an interval of 2 seconds.

Once the radio device has successfully been logged on to the radio gateway, the network search stops and the internal alarm indicator goes out.

8. If the logon process has not been successful after a long period of time has passed, briefly remove the radio device from the base/housing and then re-insert it. The search for the radio network starts again.
9. Finish the process of logging the radio devices on to the radio gateway.
10. Check that the process of logging on to the radio gateway is complete.

Wait until the LED (H4) on the radio gateway goes out.

1. Check that the number of logged-on radio devices in the radio cell is complete.
2. Check the internal alarm indicator for the new radio device. It must not flash. The radio cell is complete and the radio devices are logged on.

3. Switch the radio gateway to normal operation.

4. Press and hold button (S1) for at least 2 seconds.

LED indicator (H2) goes out.

The radio gateway is in normal operation.

5. Close the radio gateway housing.
6. Activate the LSN line on the panel controller and read in the new radio device in accordance with the fire control panel documentation.
7. Make a note of the change in your documents.
- ✓ The new radio device has now been added.



#### Refer to

- *Replacing the battery pack on the radio gateway, page 45*

## 7.4.2

### Removing radio devices temporarily

An individual radio device may be removed temporarily, for example, if renovation work is being carried out.

	 <b>WARNING</b>
	<p>Risk of injury due to undetected fire</p> <p>When parts of the system are switched off, they are not monitored and no fire alarm signals are issued for them.</p> <p>Keep the amount of time during which parts are switched off to a minimum.</p> <p>Put the intended safety measures in place.</p>

	<b>NOTICE</b>
	<p>Do not remove multiple radio devices at the same time</p> <p>This may cause other radio devices to lose their connection to the radio gateway and be displayed as missing devices.</p> <p>When the devices are switched back on, faults may be reported at the station.</p>

Proceed as follows to remove a radio device temporarily:



The radio cell is in normal operation.

1. Remove the radio device by releasing it from the base or housing.
2. Perform the necessary activities.
3. Once the activities are complete, install the radio device in the same base or the same housing.

The internal alarm indicator flashes.

Wait until it has stopped flashing.

- ✓ The radio device has now been successfully logged on. You can temporarily remove the next radio device.

### 7.4.3 Removing radio devices permanently

When radio devices are removed permanently, the radio cell changes. The planning specifications must be adhered to. If you are removing multiple radio devices, you must finish removing one before you start removing the next one.

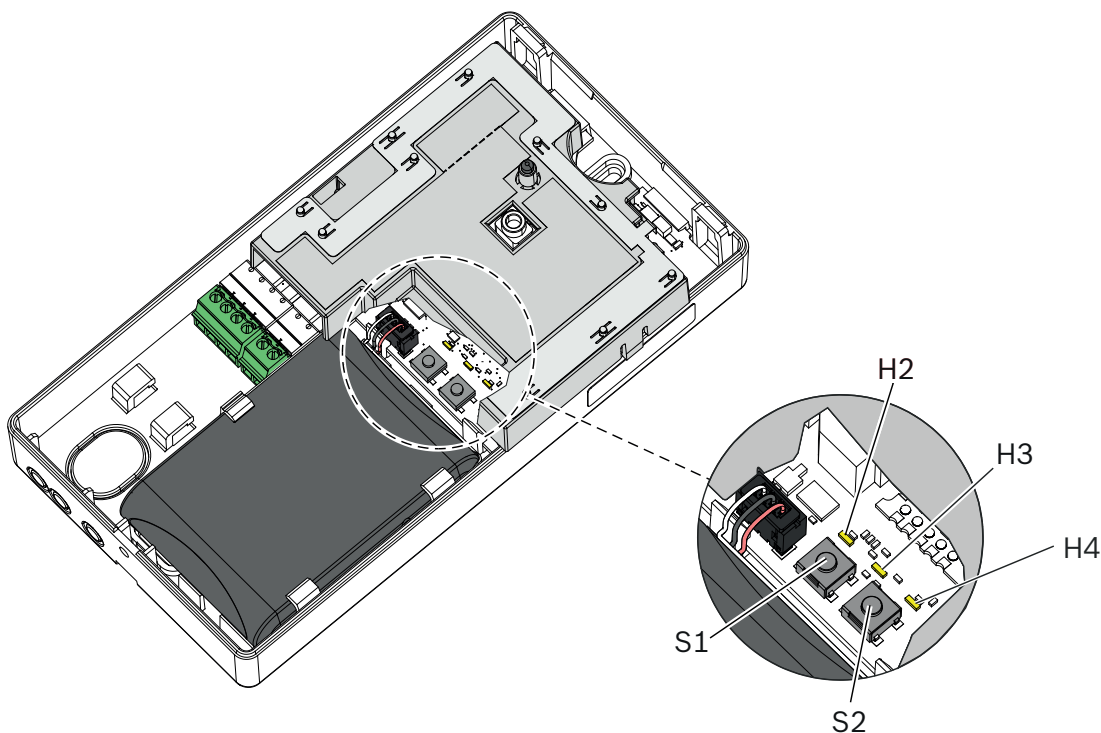

Figure 7.5: Radio gateway FWI-270

H2	LED (yellow) for maintenance mode (MC-State)	S1	Button for maintenance mode
H3	LED (yellow) for trouble indication (Fault/Bat)	S2	Reset button
H4	LED (yellow) for radio network (Network)		

Proceed as follows to remove a radio device:

You have a device location plan showing the locations of the radio devices in the radio cell.

It is possible to access the station.

1. Identify the location of the radio device.
2. Press and hold button (S1) for at least 2 seconds until LED (H2) flashes.  
The radio gateway is in maintenance mode.  
LED (H2) flashes at 1-second intervals.



- The radio devices can now be logged on.
3. Remove the radio device from the base or housing.  
The internal alarm indicator flashes briefly at 2-second intervals.
  4. Remove the base or housing.
  5. Remove the battery pack from the radio device.
  6. Store, transport, and dispose of the battery pack in accordance with local regulations and laws.  
The radio gateway registers the radio device as missing after a maximum of 5 minutes.  
LED (H4) flashes.
  7. When LED (H4) flashes, press and hold button (S1) for at least 2 seconds.  
The radio cell switches to normal operation.  
The radio gateway deletes the missing radio device from its memory.
  8. Follow the same steps to remove the next radio device. Start with step 2.
  9. Complete the work as instructed by the fire detection system documentation.
  10. Make a note of the change in your documents.
- ✓ The radio devices have now been removed.

#### 7.4.4

#### Replacing a radio device with another of the same type

If you replace a radio device with another device of the same type, the ID of the new radio device needs to be updated in the FSP-5000-RPS configuration.



If you want to replace multiple radio devices, you must finish replacing one device before you start replacing the next one. The site configuration needs to be updated.

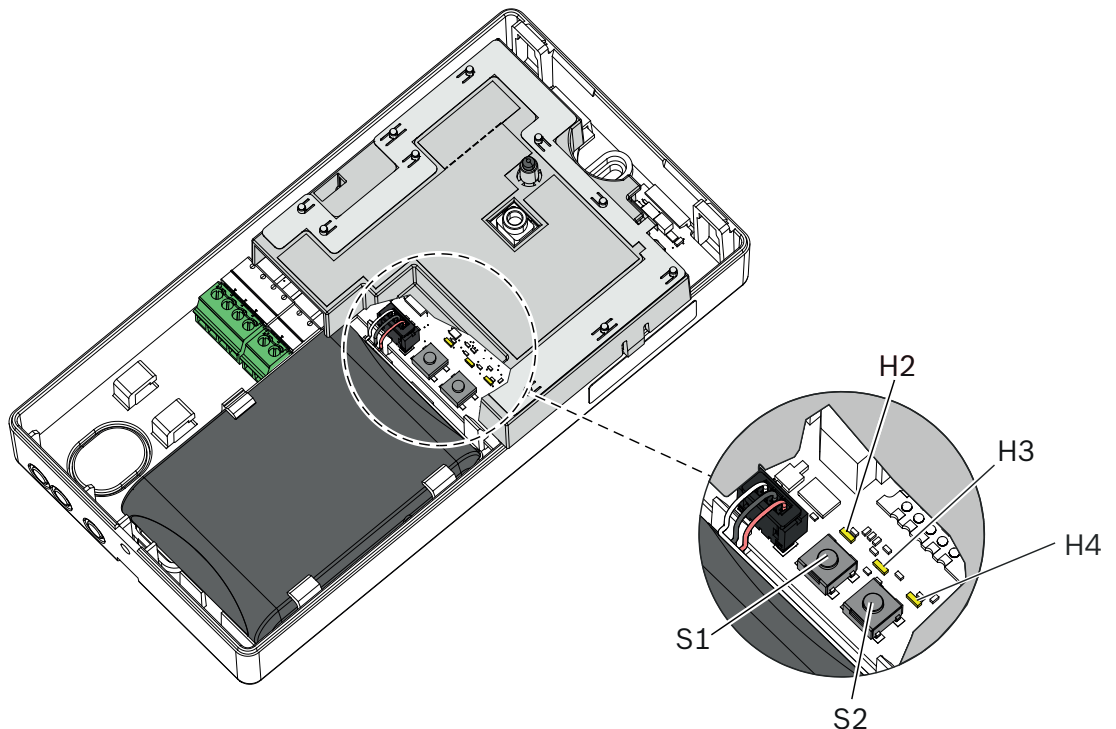

**Figure 7.6:** Figure 19: Radio gateway FWI-270

H2	LED (yellow) for maintenance mode (MC-State)	S1	Button for maintenance mode
H3	LED (yellow) for trouble indication (Fault/Bat)	S2	Reset button
H4	LED (yellow) for radio network (Network)		

Proceed as follows to replace the radio device:

The housing for the radio gateway is open.

Observe the corresponding chapter according changing and expanding the LSN line in the fire detection system documentation.

1. Set the radio gateway to maintenance mode.
2. Press and hold button (S1) for at least 2 seconds until LED (H2) flashes.  
The radio gateway and its radio cell are in maintenance mode.  
LED (H2) flashes at 1-second intervals.  
The radio devices can now be logged off and on.
3. Remove the old radio device from the base or housing.  
The internal alarm indicator flashes briefly at 2-second intervals.
4. Remove the battery pack from the radio device.
5. Store, transport, and dispose of the battery pack in accordance with local regulations and laws.  
The radio gateway registers the old radio device as missing after a maximum of 5 minutes.  
LED (H4) flashes.
6. Remove the adhesive label from the radio device and use it to mark the installation location on the device location plan.
7. Connect a new battery to the radio device.  
The internal alarm indicator of the radio device flashes.  
If it flashes red, this indicates the factory settings.  
If it flashes green, this indicates that the radio device has already been logged on to a radio gateway and needs to be set to the factory settings.
8. To set a radio device to the factory settings, press the 'new' button on the radio device until the internal alarm indicator flashes red.  
The radio device is set to the factory settings.
9. Install the radio device in the appropriate base (FDOOT271-O) or the appropriate housing (FDM273-O).  
The search for the radio network starts. During the search, the internal alarm indicator briefly flashes green twice, at an interval of 2 seconds.  
Once the radio device has successfully been logged on to the radio gateway, the network search stops and the internal alarm indicator goes out.
10. If the logon process has not been successful after a long period of time has passed, briefly remove the radio device from the base/housing and then re-insert it.  
The search for the radio network starts again.
11. Finish the process of logging the radio devices on to the radio gateway.  
Check that the process of logging on to the radio gateway is complete.  
Wait until the LED (H4) on the radio gateway goes out.
1. Press and hold button (S1) for at least 2 seconds.  
The radio cell is in normal operation.

- The radio gateway deletes the old radio device from its memory.
2. Close the radio gateway housing.
  3. Switch the LSN line on at the station and read in the new radio device in accordance with the documents for the fire control panel.
  4. Update the FSP-5000-RPS configuration.
  5. Make a note of the change in your documents.
- ✓ The radio device has now been replaced.

## 7.5 Replacing the radio gateway and transferring data

If an existing radio gateway is to be replaced with a new radio gateway in the same position, all data from the old radio gateway can be transferred to the new radio gateway.

The 'FXS2061 Diagnostic Tool' software needs to be used in order to transfer the data.

### 7.5.1 Replacing the radio gateway FWI-270



#### **Danger!**

Remove the auxiliary power supply if you want to connect FDUZ227 MCL-USB adapter radio to the gateway!

When the radio gateway is replaced, the saved radio gateway data can be transferred to the new radio gateway.



The new radio gateway takes over the identity of the old radio gateway.

The old radio gateway must no longer be used in the same fire detection installation, as the old radio gateway uses the same net ID as the new radio gateway.

After it has been reset to the factory settings, the old radio gateway can be used again.

The new radio gateway with a new, connected battery pack is available.

The old radio gateway is logged onto a fire control panel.

The MCL-USB adapter (radio) FDUZ227 is connected to the old radio gateway using a cable.

1. Proceed according to chapter 'Removing or replacing non-stationary devices' in the fire detection system documentation.
  2. Remove the cable connection to the LSN line on the radio gateway.
  3. Select the relevant radio gateway in the task card 'Network'.
  4. Select the 'Update' command from the 'Exchange Gateway' menu bar.
  5. Enter your password. The initial password is '12345678'.
  6. Follow the instructions exactly as they are shown in the window.  
If you have carried out all the steps, then confirm this with 'OK'.  
The data is loaded from the old gateway.
- ✓ The window with the command for changing the gateway appears.

	<p>Only confirm with 'OK' once you have switched gateways.</p>
---	--

Now switch gateways by connecting the 3.5 mm jack cable to the new gateway.

1. Confirm the successful data transfer with 'OK'.
2. The new radio gateway automatically has the net ID of the old radio gateway.
3. Check whether the LED (H4) is flashing.
4. Overwrite the net ID of the new radio gateway with the net ID of the old radio gateway on the type plate.
5. Wait until LED (H4) stops flashing. This can take up to 30 minutes depending on the size of the radio cell.
6. Install the new radio gateway at the location of the old radio gateway.
7. Establish a cable connection to the LSN line.
8. Switch the LSN line on.
9. Dispose of the old, unusable radio gateway in an environmentally friendly manner.

**NOTICE! If you want to reuse the radio gateway, note the information at the beginning of this chapter.**

- ✓ The radio gateway is replaced.

## 7.6

### Basic principles for replacing the battery pack

	<p><b>! WARNING</b></p> <p><b>Risk of explosion due to fire or short-circuit, even with a discharged battery pack</b></p> <p>Injury due to flying parts</p> <ul style="list-style-type: none"> <li>- Isolate the connections and attach the battery cable to the battery pack to avoid a short-circuit of the connection wires.</li> <li>- Prevent the battery pack from coming into contact with water.</li> <li>- Do not extinguish a burning battery pack with water.</li> <li>- Do not recharge the battery pack.</li> <li>- Do not damage or disassemble the battery pack.</li> <li>- Do not heat the battery pack to over 100°C.</li> </ul>
---	---

	<p><b>! WARNING</b></p> <p><b>Disposal of damaged or leaking battery pack</b></p> <p>Lithium can cause skin burns and create toxic vapors.</p> <ul style="list-style-type: none"> <li>- Avoid direct skin contact.</li> <li>- Wear protective clothing, such as protective gloves and goggles.</li> <li>- Avoid breathing in the vapors. Ensure good ventilation.</li> <li>- Use a suitable means of transport to transport damaged batteries.</li> </ul>
---	---

Always observe the following information:

When the control panel issues the message 'Battery low', replace the battery pack. The message 'Battery critical' is issued as a fault.

Use the control panel to identify the location of the radio device.

Only use battery pack BAT3.6-10.

The battery pack must be new and free from damage. The battery cable is attached to the battery pack with an adhesive label.

Store, transport, and dispose of the battery pack in accordance with local regulations, guidelines, and laws.

Label the battery pack with the commissioning date.

**Refer to**

– *Environmental compatibility and disposal, page 51*

## 7.7

### Replacing the battery pack on the radio gateway



**Warning!**

Only new battery packs may be used for replacement.

---



**Warning!**

The battery packs must be replaced after 5 years at the latest.

---

Indications that the battery pack needs to be replaced:

The control panel signals a battery fault for the radio gateway.

LED (H3) flashes once a second.

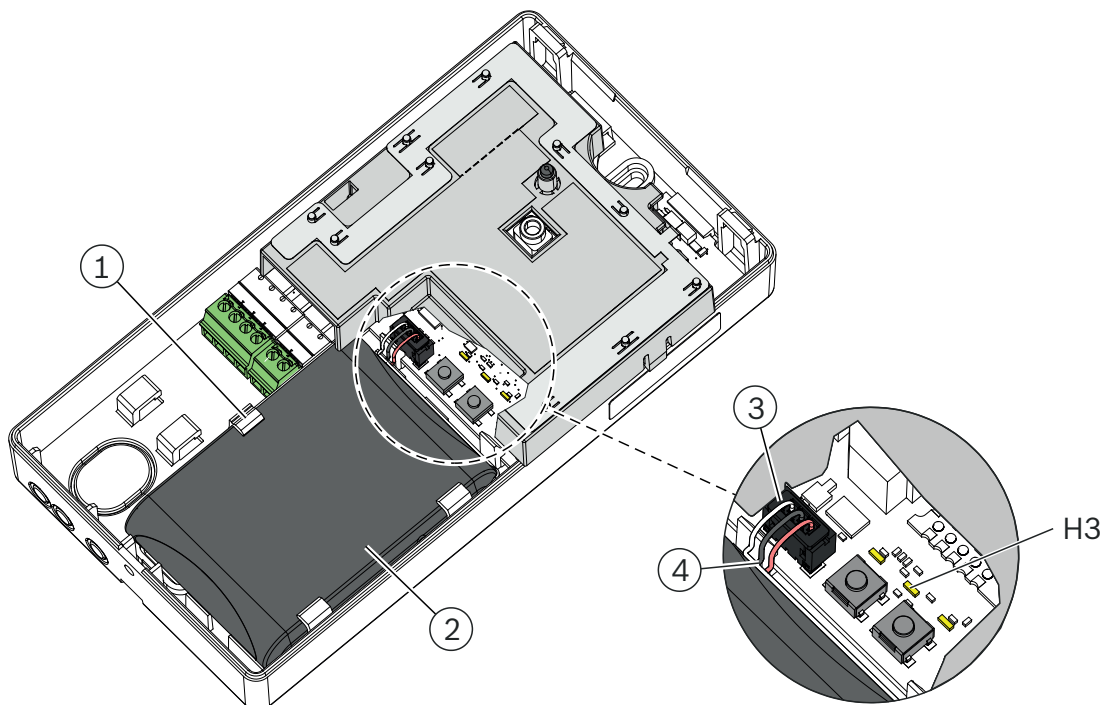

**Figure 7.7:** Radio gateway with battery pack inserted

1	Holder for battery pack	4	Battery cable
2	Battery pack	H3	LED (yellow) for trouble indication
3	Battery connector (3-pin)		

The radio gateway is connected to the LSN line and is being supplied with auxiliary power supply. This connection must not be interrupted while the battery is being replaced. You have a new, undamaged battery pack BAT3.6-10 to hand.

1. Open the housing cover.
  2. Release the battery connector (3).
  3. Push the holder (1) to the side.
  4. Remove the old battery pack (2) and dispose of it.
  5. Label the new battery pack with the current date (on the inscription field).
  6. Wait until the control panel shows 'BATTERY MISSING' after 5...10 seconds.
  7. Insert the new battery pack (2).
  8. Make sure that it latches into the holders correctly.
  9. Install the battery cable (4) as indicated by the drawing.
  10. Connect the battery connector (3).
  11. Close the housing cover.
- ✓ The battery pack has now been replaced.

The radio gateway is ready for operation immediately. There will be a delay before the fault message is cleared from the fire alarm control panel.

## 8 Specifications

Unless otherwise mentioned, the following data applies:

Temperature	= 25 °C
Air pressure	= 1000 hPa (750 Torr)

You will find information on approvals on the data sheet for the device.

### 8.1 Technical data

<b>Battery pack BAT3.6-10</b>	Lithium battery pack	BAT3.6-10 LI-SOCI2 battery pack 3.6 V, 10 Ah
	Service life	5 years in normal operation*
	Battery voltage monitored	Yes
	Weight	0.093 kg

#### Connections

Design	Screw terminals on plug
Cable cross section	0.2...1.5 mm <sup>2</sup>
MC link:	3.5 mm jack socket

#### Standards

European standards	EN 54-17 EN 54-18 EN 54-25 EN 300220-2
--------------------	---

\*= up to 5 years at standard climate. This value may vary, depending on the actual climate and the actual conditions. If the system is operated regularly or continuously at temperatures within the limit range (<15°C or >35°C), a maintenance interval of 3 years is recommended.

#### Radio transmission

Frequency range	433.05...434.79 MHz in band 44b and 45b <sup>1</sup> 868...870 MHz in band 48, 49, 50, 55, and 56b <sup>1</sup>
Channel grid	50 kHz
Number of channels	27 in 868-MHz band 20 in 433-MHz band
Transmitting power	≤10 mW ERP in band 44b, 45b, and 49 <sup>1</sup> Type 10 (max. ≤25) mW ERP in band 48, 50, 55, and 56b <sup>1</sup>

<sup>1</sup> 2013/752/EU: according Official Journal of the European Union, COMMISSION IMPLEMENTING DECISION of 11 December 2013 amending Decision 2006/771/EC on harmonization of the radio spectrum for use by short-range devices and repealing Decision 2005/928/EC (notified under document C(2013) 8776) (Text with EEA relevance)

<b>Top band</b>			<b>Bottom band</b>	
Channel	Frequency (MHz)		Channel	Frequency (MHz)
12	868.325		144	433.425
14	868.375		146	433.475
16	868.425		148	433.525
18	868.475		150	433.575
20	868.525		152	433.625
22	868.575		154	433.675
26	868.675		156	433.725
30	868.775		158	433.775
32	868.825		160	433.825
34	868.875		162	433.875
36	868.925		164	433.925
38	868.975		166	433.975
40	869.025		168	434.025
42	869.075		170	434.075
44	869.125		172	434.125
46	869.175		174	434.175
56	869.425		176	434.225
58	869.475		178	434.275
60	869.525		180	434.325
62	869.575		182	434.375
64	869.625			
68	869.725			
70	869.775			
72	869.825			
74	869.875			
76	869.925			
78	869.975			

**Electrical**

Operating voltage LSN (VDC)	15 to 33
Operating voltage AUX (VDC)	15 to 30
Max. LSN current consumption (mA)	3.45



Average auxilliary current consumption (mA)	10
Max. auxilliary current consumption (mA)	30
Battery service life	5 years in normal operation*
* = up to 5 years at standard climate. This value may vary, depending on the actual climate and the actual conditions. If the system is operated regularly or continuously at temperatures within the limit range (<15°C or >35°C), a maintenance interval of 3 years is recommended.	

#### Environmental

Protection class as per EN 60529	IP40
Permissible operating temperature (°C)	-10 to +55
Permissible storage temperature (°C)	-20 to +70
Relative humidity (%)	<96 (non-condensing)

#### Mechanical

Housing material	Acrylonitrile-butadiene-styrene (ABS)
Color	Pure white, ~RAL 9010
Weight (without/with packaging) (g)	Approx. 155/327
Dimensions H x W x D (mm)	Approx. 167 x 89 x 28

## 8.2 Dimensions

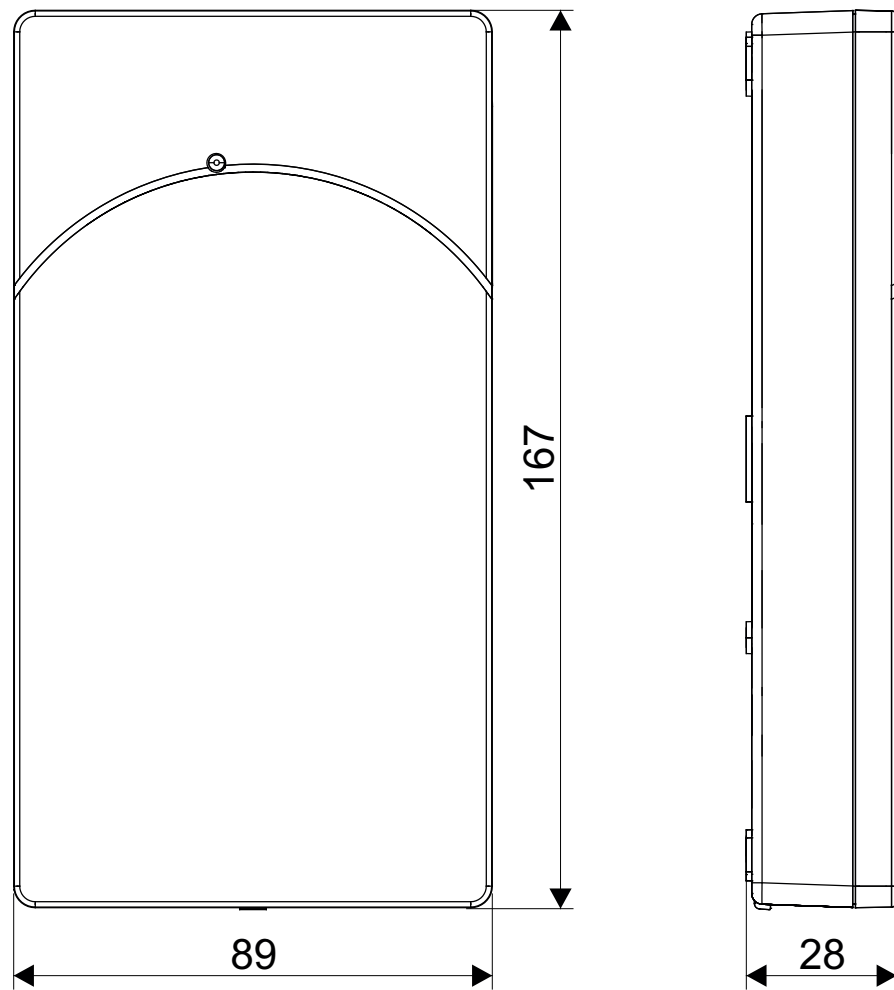

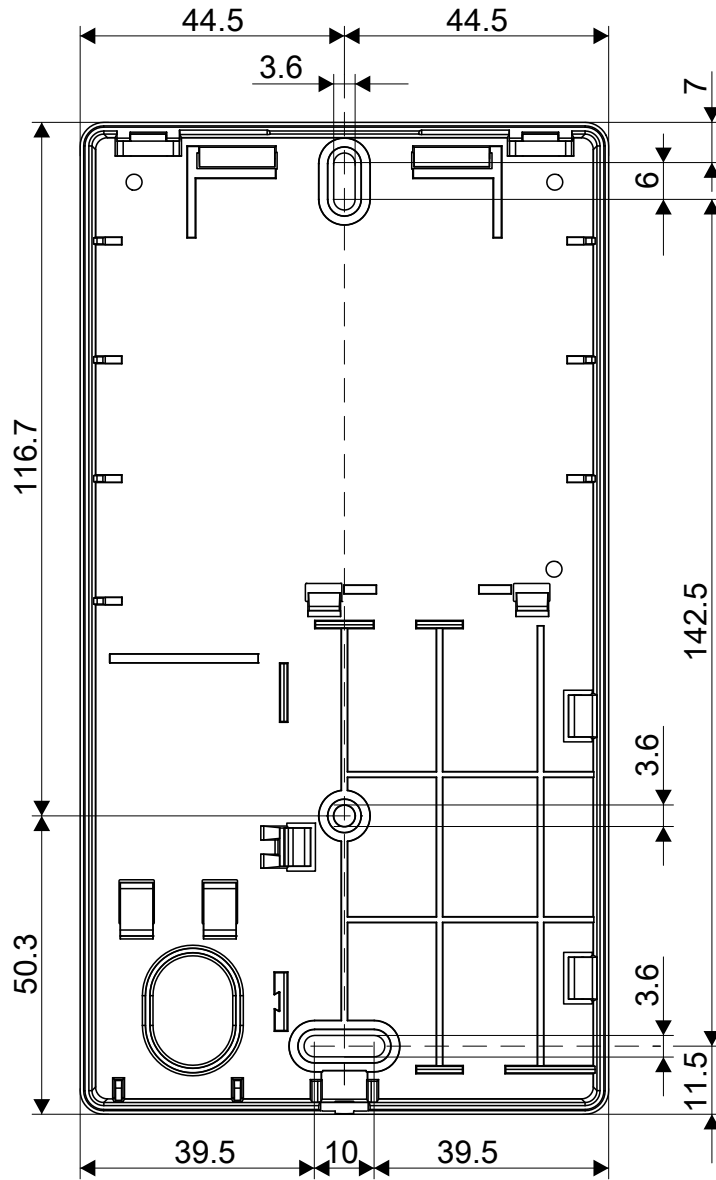

### 8.3 Master gauge for recesses

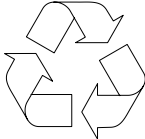

### 8.4 Environmental compatibility and disposal

	<p>This equipment is manufactured using materials and procedures which comply with current environmental protection standards as best as possible. More specifically, the following measures have been undertaken:</p> <ul style="list-style-type: none"> <li>Use of reusable materials</li> <li>Use of halogen-free plastics</li> <li>Electronic parts and synthetic materials can be separated</li> <li>Larger plastic parts are labeled according to ISO 11469 and ISO 1043. The plastics can be separated and recycled on this basis.</li> </ul>
---	--

 	<p>The device is considered an electronic device for disposal in accordance with the European Guidelines and may not be disposed of as domestic garbage.</p> <p>Dispose of the device through channels provided for this purpose.</p> <p>Comply with all local and currently applicable laws and regulations.</p>
--	---







**Bosch Sicherheitssysteme GmbH**

Robert-Bosch-Ring 5

85630 Grasbrunn

Germany

**[www.boschsecurity.com](http://www.boschsecurity.com)**

© Bosch Sicherheitssysteme GmbH, 2022

**Building solutions for a better life.**

202201270702