



BOSCH

Conventional fire panel

FPC-500



en

Installation manual

Table of contents

1	Safety Instructions	6
2	System Overview	7
2.1	Operating Levels	11
3	Installation	11
3.1	Scope of Delivery	11
3.2	Installation	12
3.2.1	Inserting the Cable	12
3.2.2	Opening the Housing	13
3.2.3	Installing the Housing	13
3.2.4	Mains Supply	14
3.2.5	Batteries, 24 V Emergency Power Supply	15
3.2.6	Extensions	17
3.3	Wiring	18
3.3.1	Inputs	19
3.3.2	Zones	20
3.3.3	Aux power	21
3.3.4	Notification Appliances	23
3.3.5	Relay Outputs	24
3.3.6	Extensions	25
3.4	Initial Start-Up	25
3.4.1	Setting the Language	25
3.4.2	Setting the Time and Date	25
4	System Configuration	26
4.1	System Configuration	29
4.1.1	Setting the Date/Time	29
4.1.2	Buzzer Beep	29
4.1.3	EOL Elements	30
4.1.4	Resetting Zones	31
4.1.5	Aux Power	32
4.1.6	Faults	32
4.1.7	Level Code	33
4.1.8	Test Log	34
4.2	Configuring Delays	34
4.2.1	Deactivating Day Mode	34

4.2.2	Alarm Verification	35
4.2.3	Intermediate Alarm Storage	37
4.2.4	Delay for Mains Fault	39
4.3	Zone Configuration	39
4.4	Configuring Inputs	42
4.4.1	Input 1	43
4.4.2	Input 2 (FPC-500-8 only)	43
4.5	Configuring Outputs	44
4.5.1	Notification Appliances	44
4.5.2	Alarm Relay	46
4.5.3	OC/Relay Extensions	47
4.6	Displaying the Configuration	48
4.7	Controlling Outputs	48
4.7.1	Notification appliance 1	48
4.7.2	Notification appliance 2	49
4.7.3	Alarm Relay	49
4.7.4	Fault Relay	49
4.7.5	OC/Relay Extension	50
4.7.6	Control all outputs	50
4.8	Resetting To Delivery State	51
5	Fault Diagnosis	51
6	Technical Data	52
6.1	Electrical Data	52
6.1.1	Communication parameters	54
6.2	Mechanical	55
6.3	Environmental Conditions	55
6.4	Information as per EN 54-4, chapter 7.1	56
6.5	Options with requirements as per EN 54-2:1997/A1:2006	57
7	Appendix	58
7.1	Brief Overview, Operating Level 1 and 2	58
7.2	Test menu	59
7.3	Brief Overview, Operating Level 3	60
7.4	Default Settings	70
7.5	Event Memory	72
7.6	Test Memory Messages	73

1 Safety Instructions

**Danger!**

The fire panel may only be operated with the housing closed because of the danger of an electric shock.

**Danger!**

Connect the panel to a mains supply line protected by a double pole fuse with a double pole manual circuit breaker. Only perform installation work when the mains supply line has been interrupted by the circuit breaker.

**Caution!**

Installation may only be performed by authorized qualified personnel in order to ensure that the system is not damaged and operates properly.

**Notice!**

Note local regulations when connecting to 230 V power supplies.

**Notice!**

Please observe the country-specific regulations and guidelines during planning, installation and programming of the fire panel.

**Notice!**

In line with EN 54-13 (BOSEC certificate TCC 2 - 977), each conventional line must be terminated with EOL modules for the operation of fire detection systems.

The AUX power supply must also be terminated with EOL modules when using four-wire detectors.



Notice!

The fire panel has been designed for operation in closed rooms. Please note the permissible environmental conditions in the technical specifications.

2 System Overview

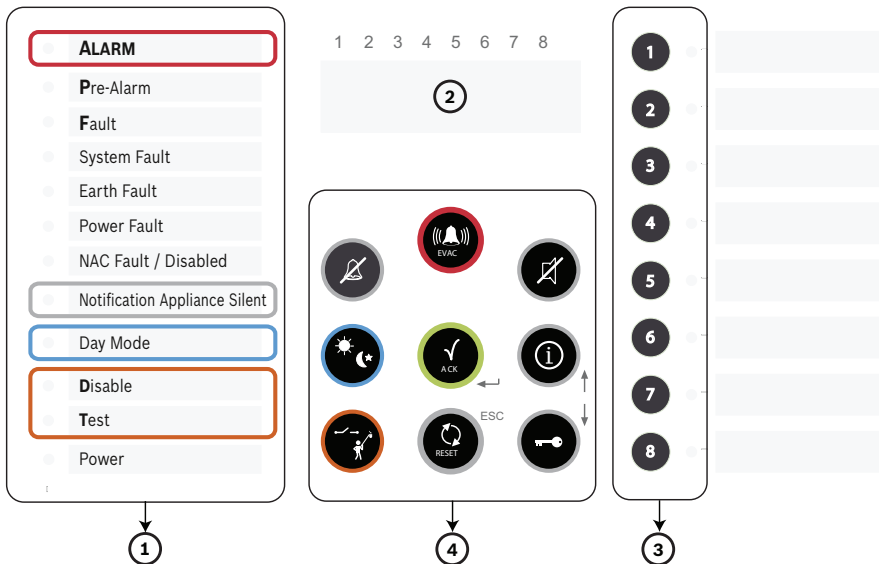



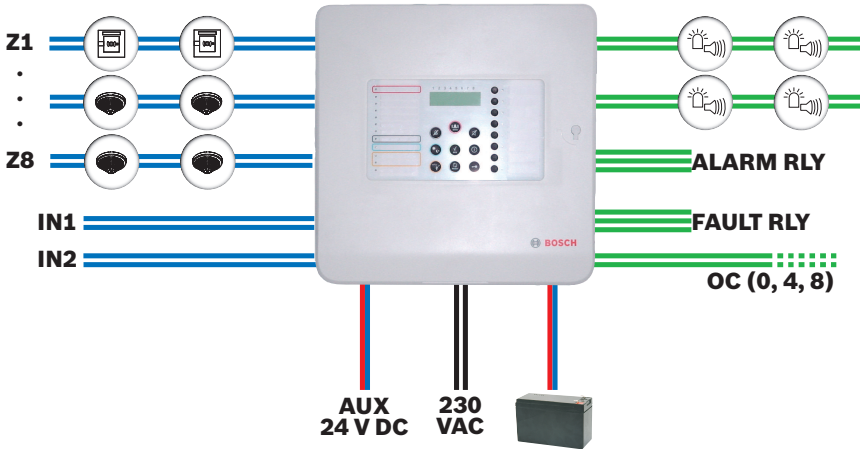

1	LED display
2	LCD display with zone numbers
3	Zone keys and zone status LEDs
4	Operating panel

	FPC-500-2	FPC-500-4	FPC-500-8
Inputs			
– Zones	2	4	8
– Prog. inputs	1	1	2
Outputs			
– Prog. AUX (500 mA)		1	

	FPC-500-2	FPC-500-4	FPC-500-8
<ul style="list-style-type: none"> - Alarm device, 500 mA each - Relay 		2 2	
Extensions <ul style="list-style-type: none"> - Open collector (20 mA) - Relay (via OC) 	no	1 x 4	2 x 4
LCD, 2 x 16 characters	Yes		



	Conventional detectors
	Conventional manual call point
	Visual or audible notification appliances

 Z1 ... Z8	Conventional zones 1 to 8 (max. 2 on FPC-500-2, max. 4 on FPC-500-4)
 IN	Inputs (max. 1 on FPC-500-2 and FPC-500-4, max. 2 on FPC-500-8)
 ALARM RLY	Alarm relay
 FAULT RLY	Fault relay
 OC	Transistor output for extension cards (0 on FPC-500-2, 4 on FPC-500-4, 8 on FPC-500-8)
AUX 24 VDC	AUX power supply

Features

- Alarm verification: The user is prompted to verify the alarm.
- Intermediate alarm storage: an alarm triggered by an automatic detector is reset automatically after 20 seconds (adjustable) by the panel. If there is an additional alarm within 10 minutes in this zone, the notification appliances are enabled. Otherwise the pre-alarm is reset automatically.
- Dual-zone dependency on neighboring zones.
- Dual-detector dependency for detectors in a zone.
- Alarm counter for 999 alarms.
- Event memory for 1000 entries.
- Three operating levels, two of them protected with freely selected code.
- Up to 8 monitored detector zones depending on panel version.
- Up to 2 monitored inputs available depending on panel version.
- One alarm and one fault relay.
- Up to 8 additional transistor or relay outputs, freely programmable, depending on panel version.

- Quick and easy programming using the keypad and LCD display.
- Easy operation for the end user.
- Two monitored notification appliance outputs.
- EN 54-13 (BOSEC certificate TCC 2 - 977) compliant system by using EOL modules.
- Power supply via power supply unit with thermal fuse.
- Emergency power supply using batteries, up to 7.2 Ah, reverse polarity protected.
- Removable quick guide for the user on the panel.

2.1 Operating Levels

This fire panel has three operating levels. You can only perform certain actions depending on operating level.

- Level 1
 - Display information
 - Read out event memory
 - Display faults and deactivations
 - Perform display test
- Level 2
 - Change language and time/date
 - Switch key tones on/off
 - Put zones in test mode and take zones out of test mode
 - Switch off/on zones, notification appliances, relay and transistor outputs
 - Trigger evacuations
 - Reset panel
 - Switch between day/night mode
 - All actions of level 1
- Level 3
 - All settings for installing and programming the system.

Code inputs are necessary for accessing level 2 and 3.

3 Installation

3.1 Scope of Delivery

The fire panel packaging contains the following components:

- Fire panel FPC-500-2/FPC-500-4/FPC-500-8
- EOL resistors for zones and inputs
- Battery cable set
- Cable ties for strain relief on power supply feeder
- Labeling strips for zones and LEDs
- Quick Installation Guide
- Quick Operation Guide
- CD

- Two plastic foam blocks for securing the batteries

3.2 Installation



Notice!

Install the fire panel in a location easily accessible to emergency response teams (e.g. fire department).

Note permissible environmental conditions.

Install the fire panel at a height between 0,80 m and 1,80 m above the ground that permits convenient operation by the user and easy reading of the LCD display.

3.2.1 Inserting the Cable

Route the necessary cables for zones, inputs and outputs, as well as the power supply, etc., and carefully punch out the cable entries needed for this.



Warning!

Electrostatic discharge (ESD)! Electronic components could become damaged. Ground yourself using a wrist strap or take other suitable measures.

Remove the PC board if necessary. This is secured in the housing with a grounding screw and snap-fit hook.

For cable entry on the upper side of the housing, use the pre-formed round holes. For a stable and safe insertion, use cable glands with M 20 x 1,5 screw joints (PG13,5)

The cable entries on the rear are intended for direct cable entry of flush mounted cables.

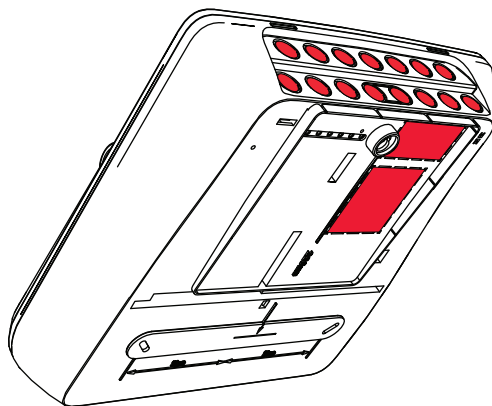

3.2.2 Opening the Housing

Remove the cover of the fire panel. Loosen both screws on the underside of the housing, lift up the cover approx. 20° and remove it.

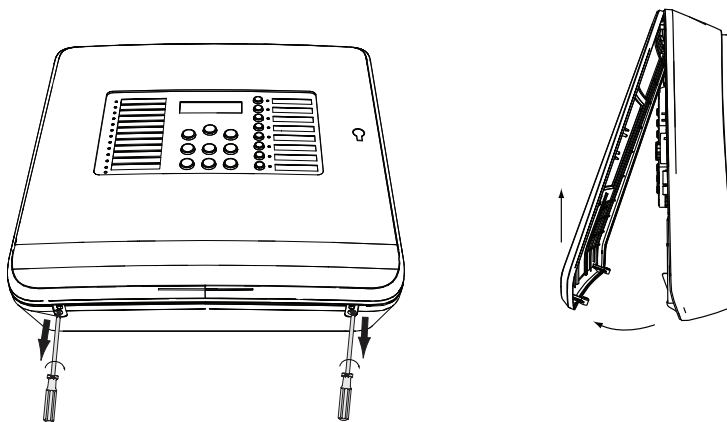

3.2.3 Installing the Housing

Use the panel housing to draw drill holes at the desired location on the wall (arrows in figure below). As an option, you can use the mounting dimensions indicated on the back of the housing. Ensure that the housing is aligned horizontally and draw on the

holes using the built-in spirit level in the upper left corner. The dimensions can be taken from the drilling jib on the rear of the housing. Drill the holes.

Guide the cables routed under plaster through the punched out cable ducts on the rear of the housing into the housing. Mount the housing to the wall using screws. Make sure that cables are not pinched.

Then guide the cables routed on plaster through the cable entries to the upper side of the housing.

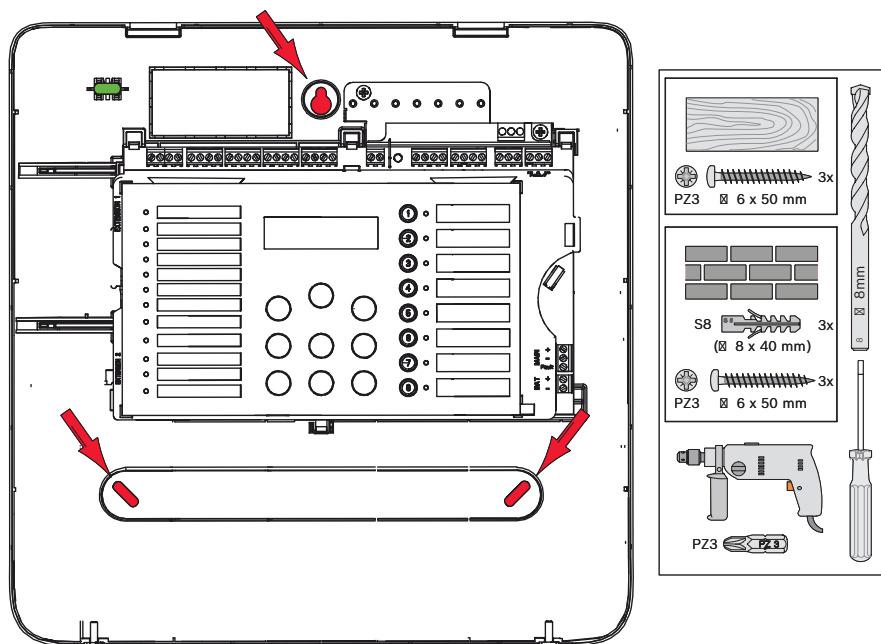

3.2.4 Mains Supply

The fire panel requires a 230 V mains supply for the power supply. Route the power supply so that the line does not cross or touch the signal line.

Use the left M 20 x 1.5 screw joint (PG13.5) on the upper side of the panel for the 230 V mains supply.

**Notice!**

Note local regulations when connecting to 230 V power supplies.

Wire up the 230 V power supply to the screw clamp provided on the power supply unit board. Use a cable tie to ensure strain relief of the power supply feeder in the housing above the power supply unit.

**Danger!**

Connect the panel to a mains supply line protected by a double pole fuse with a double pole manual circuit breaker. Only perform installation work when the mains supply line has been interrupted by the circuit breaker. There is a danger of an electric shock.

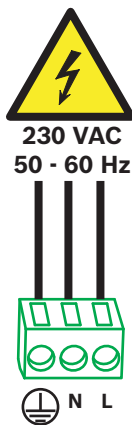
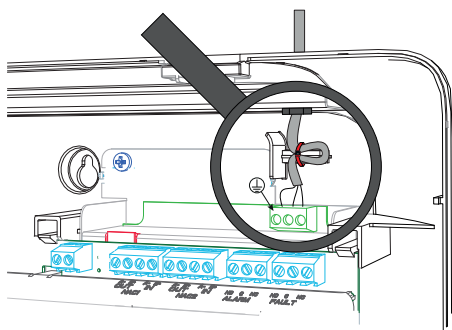

3.2.5 Batteries, 24 V Emergency Power Supply

You can use two 12 V batteries with maximum 7.2 Ah each in the housing as emergency power supply.

The batteries are connected in series. If the mains power fails, they are used to ensure interruption-free power supply of the fire panel and the components fed by them.

**Notice!**

The fire panel can also only be started with the batteries if the power supply is disconnected.

After you have placed the batteries in the housing, secure them using the plastic foam blocks provided.

Position the plastic foam blocks in between the top of the batteries and the housing.

There are different emergency current back-up times depending on the battery capacity used and the current consumption of the components connected to the panel. You can calculate this using the battery calculator included on the CD.

After troubleshooting a mains fault and operating the fire panel via emergency current, the power supply unit switches back to mains operation automatically. The batteries are charged again automatically.

**Notice!**

Note the polarity of the batteries.

If the batteries are connected with the polarity reversed, the thermal fuse on the main board of the fire panel reacts.

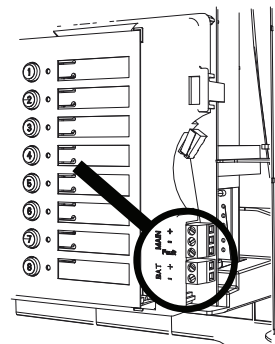
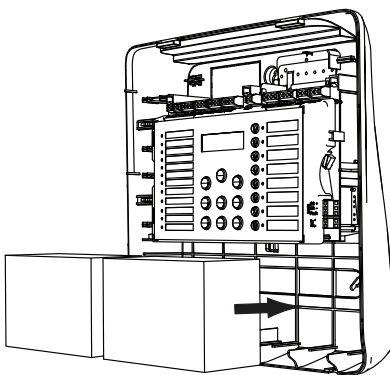

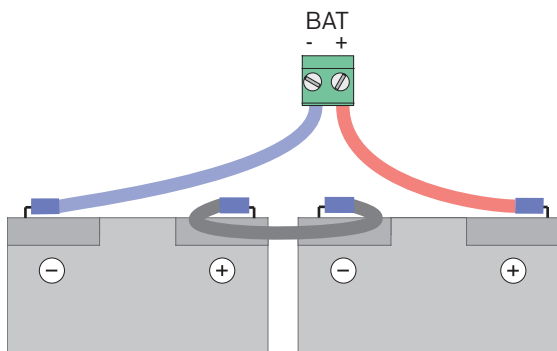

Secure the batteries with the plastic foam blocks provided so that they cannot move.

3.2.6 Extensions

**Notice!**

Note that the maximum line resistance for transistor outputs is 22.5 Ohm.

The extensions are connected to the left side of the main board. Simply connect the board to the plugs. Make sure that the plug engages correctly.

There is a groove on the top of the extensions. Make sure that the board has been correctly installed.

**Notice!**

A maximum of two extensions can be connected:

FPC-500-2: No extension can be connected

FPC-500-4: One extension can be connected

FPC-500-8: Two extensions can be connected

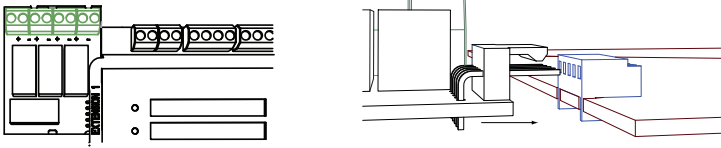

3.3 Wiring

External components such as zones, notification appliances, inputs, etc. are wired to screw terminals attached to the upper side of the board.

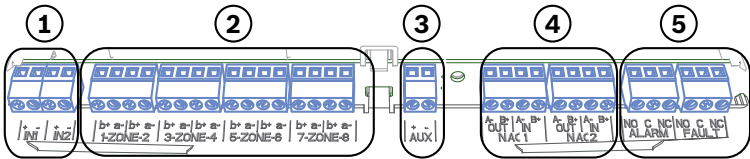

No.	Meaning	FPC-500-2	FPC-500-4	FPC-500-8
1	Inputs	1	1	2
2	Zones	2	4	8
3	Aux power supply		1	
4	Notification appliance		2	
5	Alarm and fault relay		1/1	

Notice!



The screw terminals are designed for a cable diameter of 0.8 mm and for cable cross sections of up to 1.5 mm².

The fire panel is designed for unshielded cable. If you do use shielded cable, only connect the cable shielding to the earth bar on one side above the power supply unit.

Terminal resistances

The zones of the fire panels must be terminated. Use either resistors or in case of EN 54-13 (BOSEC certificate TCC 2 - 977) the EOL modules.



Notice!

Only use resistors with a maximum 1% tolerance.
The 3.9 kOhm resistors are supplied.

3.3.1 Inputs

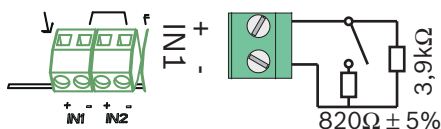

The fire panel offers two control inputs. You can assign different functions to these depending on programming (see *Configuring Inputs, page 42*).

The connection terminals IN1 and IN2 are available.



Notice!

Note that the maximum line resistance for inputs is 22.5 ohm.
Use 820 Ohm $\pm 5\%$ resistors for the alarm resistance (not included in scope of delivery).



Notice!

Only use buttons (no locking element) if you have programmed inputs as **Drill/Evacuate**, **Silence**, or **Reset Panel**.
Access levels as per EN 54-2 must be observed.

3.3.2 Zones

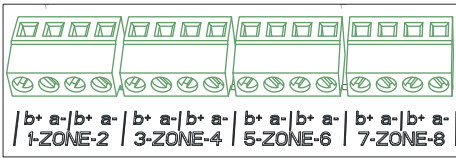

Notice!

Do not connect the zone- with any power+ like for example: AUX power, external power supply or batteries for emergency power supply.

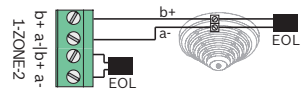
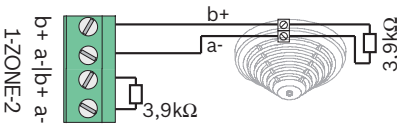

EN 54-13 (BOSEC
certificate TCC 2 - 977)

Each zone must be completed with a terminal element.
You can either use a $3.9\text{ k}\Omega \pm 1\%$ resistor or EOL modules for an EN 54-13 (BOSEC certificate TCC 2 - 977) compliant termination.
Unused zones must also be terminated with a terminal element.
Mixing different terminal elements is not allowed.



Notice!

Note that the maximum line resistance for conventional zones is 22.5 Ohm .

The voltage of the zones is $20\text{ VDC} \pm 1\text{ V}$.

The maximum current of the zones is $100\text{ mA} \pm 5\text{ mA}$.



Notice!

Observe local regulations for the maximum number of detectors in a zone.

When using the FLM-320-EOL4W Module, use the battery calculator included on the CD.



Notice!

The last zone of the fire panel supports the use of 4-wire detectors.

The fire panel does not support dual-detector dependency with 4-wire detectors.

Please use permissible external power supply units depending on power consumption.



Notice!

Activating a manual call point in a zone programmed as "**No Delay**" triggers an immediate alarm.



Notice!

Only use manual call points in zones which are programmed as **No Delay**.

3.3.3 Aux power

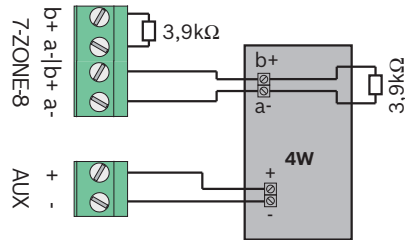

Non-EN54-13

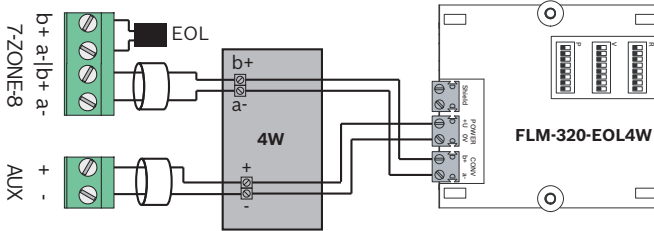

EN54-13 (BOSEC certificate TCC 2 - 977)

The fire panel allows you to use 4-wire (4W) elements on the last zone. These must be supplied with power by the auxiliary power supply or an external power source. Both the zone and the auxiliary power must be terminated by a terminal element. For EN 54-13 (BOSEC certificate TCC 2 - 977) compliant connection of 4-wire elements, the AUX and zone lines must be routed in separate cables.

You can either use a 3.9 kΩ ±1% resistor or EOL modules for EN 54-13 (BOSEC certificate TCC 2 - 977) compliant termination.

Program the reset behavior of the auxiliary power as described in *Aux Power*, page 32.



Notice!

Note that the maximum line resistance for the auxiliary power is 22.5 Ohm.

3.3.4 Notification Appliances

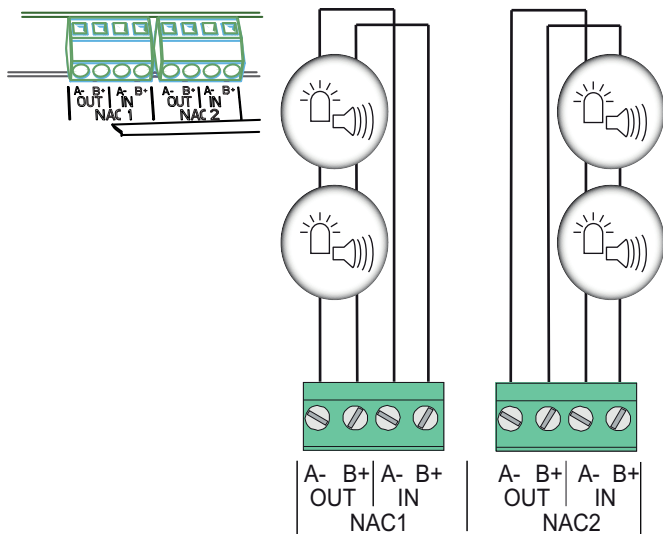

Notice!



Each notification appliance output provides connected notification appliances with a maximum current of 500 mA at 24 VDC. The permissible voltage range of the output is 21–29 VDC.

Notice!



Note that the maximum line resistance for notification appliances is 22.5 Ohm.

The fire panel offers you two notification appliance circuit lines that can be used to activate the audible notification appliances and visual notification appliances. When there is a fire alarm, the notification appliance circuit lines are activated depending on programming.

**Notice!**

Connect the notification appliances to the terminals NAC1 and/ or NAC2. This connection is EN 54-13 (BOSEC certificate TCC 2 - 977) compliant.

3.3.5 Relay Outputs

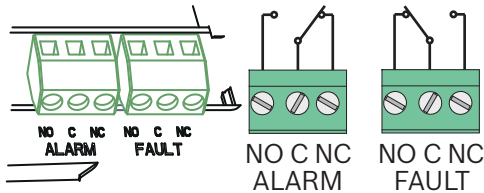
**Notice!**

The fault relay is activated in a normal state. It is opened in the event of a fault.

The fire panel has two relay outputs. The relays work as potential-free change-over contacts. The alarm relay is activated by every fire alarm.

Notice!

A transmission device must be installed in the immediate vicinity (without a space) of the FPC-500-x. The connecting line between the fire panel and the transmission device must not be exposed, as it is not monitored.

**Notice!**

Both relay outputs "ALARM" and "FAULT" can switch a maximum of 1 A @ 30 VDC each.

**Notice!**

Note that the maximum line resistance for the relay outputs is 22.5 Ohm.

3.3.6 Extensions

The extension modules offer four connections activated by transistors or relay.

**Notice!**

The relay outputs can switch a maximum of 1 A @ 30 VDC each. The transistor outputs switch a maximum of 20 mA @ 24 VDC each. Inductive loads are not permitted.

3.4 Initial Start-Up

As soon as the fire panel is connected to the power for the first time, an LED and buzzer test begins. This is completed the first time a key is pressed.

In the initial start-up, you must make the following basic settings:

- Set the language
- Set the time and date

3.4.1 Setting the Language

To set the language, proceed as follows:



	Use the arrow keys to set the desired language.
	Confirm your selection in the menu with the ACK key.

3.4.2 Setting the Time and Date

Set the current time and date. The current time and date are important for functions such as

- Event memory and

- Automatic switching to night mode.

 	Use the arrow keys to set the current day.
	Confirm your selection in the menu with the ACK key.

Repeat this procedure to set the correct values for the month, year and time.

Notice!



Summer and winter time settings are not made automatically. Make these settings manually.

If there is a total power failure, you must make the settings for the date and time again.

4 System Configuration

To be able to perform the actions in operating level 3, you will need a code you can enter with the zone keys.

Notice!





The following codes are programmed in delivery status:

Operating level 2: 1234

Operating level 3: 3333

The basic settings can be found in *Default Settings, page 70*.

Calling up operating level 3

	Press the "Code input" key. You will be prompted to enter a code.
	Enter the code with zone keys 1 to 8.

You are in the programming menu of the system.



Caution!

In operating level 3, the fire panel is not operational. None of the inputs and outputs are monitored.

Automatic exit of level 3

If you are in level 3 and no key has been pressed for 10 minutes, the system will exit level 3 automatically.

One minute before exiting level 3, a pulse tone of the internal buzzer indicates the time. The time up to the automatic exit of level 3 is displayed in the LCD display.



Exiting operating level 3



Notice!

When you exit operating level 3, the fire panel automatically switches to night mode.

If you are in operating level 3, proceed as follows.

	<p>Press the RESET key.</p> <p>You exit operating level 3 when you are at the top level of the menu. The configuration is stored and the inputs and outputs are activated.</p>
	<ul style="list-style-type: none"> - Press the ACK key to exit operating level 3. - If you do not want to exit operating level 3, press the RESET key.

Menu

Operating level 3 of the fire panel offers you the following setting options:

- **1-System Config**
- **2-Delay Config**
- **3-Zone Config**
- **4-Input Config**
- **5-Output Config**
- **6-View Config**

- **7-Output Control**
- **8-Config Reset**

**Notice!**

The structure and description of menus of operating levels 1 and 2 can be found in the operating instructions.

**Notice!**

The menus are described in these instructions as follows:

A hyphen between the number and the menu description "- " shows you that it is a menu item with a submenu.

An equals sign between the number and the menu description "= " represents a set value.

A space between the number and the menu description " " is a value that can be set.

Preset values are always shown in bold.

Operation

You have different options for navigating in the menu of the fire panel.



Using autoscrolling

The menus scroll automatically every 2.5 seconds to the next menu item. If you would like to select the menu item currently shown, simply confirm with the ACK key.

Navigating with the zone keys

In the menu, each menu item has a number from 1 to 8 preceding it. Use the zone keys to select the desired menu item in the menu. The desired menu item does not have to be shown in the display.

Navigating with the arrow keys

 	<p>Use the arrow keys to navigate in the menu. Using the arrow keys stops autoscrolling in the menus.</p>
	<p>Confirm your selection in the menu with the ACK key.</p>



Exiting submenus

	<p>In the menu and in the submenu, you can jump to a higher level or cancel the setting using the RESET (ESC) key. Hold the RESET (ESC) key down for 2 seconds to jump to the uppermost level.</p>
---	--

4.1 System Configuration

In the **System Config** menu, you can specify basic settings for your fire panel.



4.1.1 Setting the Date/Time

	<p>Press zone key 1. This takes you to the System Config menu.</p>
	<p>Press zone key 1. You can now set the date and time.</p>
	<p>To save the currently displayed value, press the ACK key.</p>

Repeat the steps to set the month, year, hour, and minute.



4.1.2 Buzzer Beep

	<p>Press zone key 1. This takes you to the System Config menu.</p>
---	---

	Press zone key 2. This takes you to the Keypad Tone submenu.
	Press zone keys 1 or 2: <ul style="list-style-type: none"> - 1=On (default setting) - 2 Off

4.1.3 EOL Elements

You can use **EOL Devices** to specify whether you want to use resistors or EOL modules for zone termination.

	Press zone key 1. This takes you to the System Config menu.
	Press zone key 3. This takes you to the EOL Devices submenu.
	Press zone keys 1 to 3: <ul style="list-style-type: none"> - 1=Resistor (default setting, not EN 54-13 compliant) - 2 Only 2W Module - 3 With 4W Module

1 2 3 4 5 6 7 8

CS TH: mA





If you select **With 4W Module**, you must specify the threshold for the creeping short-circuit.

You can calculate this using the battery calculator included on the CD.





4.1.4 Resetting Zones

In this menu, you can specify the delay times for resetting zones. You can specify how long the zones can be disconnected from the power and how long the stabilization time of the detector should last. This setting is used for the zone test, restarting the fire panel and intermediate alarm storage.

Cut For

	Press zone key 1. This takes you to the System Config menu.
	Press zone key 4. This takes you to the Zone Reset submenu.
	Press zone key 1. This takes you to the Cut For submenu.
	Press zone keys 1 to 5. <ul style="list-style-type: none"> - 1 1s - 2=5s (default setting) - 3 10s - 4 15s - 5 20s

Stabilize for

	Press zone key 1. This takes you to the System Config menu.
	Press zone key 4. This takes you to the Zone Reset submenu.
	Press zone key 2. This takes you to the Stabilize For submenu.
	Press zone keys 1 to 5. <ul style="list-style-type: none"> - 1 1s



	<ul style="list-style-type: none"> – 2=5s (default setting) – 3 10s – 4 15s – 5 20s
--	---

4.1.5 Aux Power

The **With Zone** setting relates to the last zone of the fire panel. If the last zone is reset after a pre-alarm or alarm, the AUX power supply is reset simultaneously.

The **With Panel** setting also resets the power supply each time the fire panel is reset.

If you select **Never**, the auxiliary power supply is never reset.

	Press zone key 1. This takes you to the System Config menu.
	Press zone key 5. This takes you to the Aux Power submenu.
	Press zone keys 1 to 3. <ul style="list-style-type: none"> – 1=With Zone (default setting) – 2 With Panel – 3 Never

4.1.6 Faults



The **Faults** setting specifies whether faults on the fire panel are to be displayed until the fire panel is manually reset.



Notice!

This setting does not apply to system faults. System faults can only be reset manually.

	Press zone key 1. This takes you to the System Config menu.
---	--

	Press zone key 6. This takes you to the Faults submenu.
	Press zone key 1 or 2. - 1= Latching (default setting) - 2 Non Latching



4.1.7 Level Code

In the **Level Code** menu, you can specify new codes for operating levels 2 and 3. The new code must be 4 characters long and is displayed during entry.



Notice!

The following codes are programmed in delivery status:
 Operating level 2: 1234
 Operating level 3: 3333

	Press zone key 1. This takes you to the System Config menu.
	Press zone key 7. This takes you to the Code submenu.
	- 1- Level 2 Code - 2- Level 3 Code

1 2 3 4 5 6 7 8

Level 2 Code
Set to: ____

You are prompted to enter the new code.

1 2 3 4 5 6 7 8

Level 2 Code
Confirm: ____

You then have to confirm the new code by entering it again.

The procedure for changing the code for operating level 3 is exactly the same.





Notice!

If you have forgotten your code, contact your Bosch partner.

4.1.8 Test Log

You can decide whether or not the fire panel creates a **Test History**.

	Press zone key 1. This takes you to the System Config menu.
	Press zone key 8. This takes you to the Test History submenu.
	Use zone keys 1 or 2. <ul style="list-style-type: none"> – 1=Log Enabled (default setting) – 2 Log Disabled

4.2 Configuring Delays

In the **Delay Config** menu, you can program different delay times for different zone programs, outputs and fault types.

	Press zone key 2. This takes you to the Delay Config menu.
---	---

4.2.1 Deactivating Day Mode

Specify whether you want day mode (zones with alarm verification start a verification time in the event of an alarm) to be exited manually by the user or automatically at a defined time. You can program the time in this submenu.

**Notice!**

Day mode must always be started manually; it is not possible to configure an automatic start.

	Press zone key 2. This takes you to the Delay Config menu.
	Press zone key 1. This takes you to the Day Mode Off submenu.
	Use zone keys 1 or 2. <ul style="list-style-type: none"> - 1=Manual (default setting) - 2 Automatic

If you set **Day Mode Off** to **Automatic**, you must program the changeover time from day to night mode.

1 2 3 4 5 6 7 8

Off Time: :17:00

Confirm with

Set the time with the arrow keys and confirm using the ACK key.

4.2.2 Alarm Verification

**Notice!**





This setting only applies to zones that are programmed as alarm verification.

Note that the delay settings are only effective in day mode. In night mode, the alarm is triggered immediately.





In the **Alarm Verific** menu, you set the times within which the user must confirm a triggered alarm (**ACK Within**). The **Invest Time** submenu specifies the time available to the user to enter the alarm triggering area before the notification appliance is activated. You can also use **NAC 1** to specify whether:

- **Alert** switches **NAC 1** on immediately in the event of an alarm. **NAC 1** is then switched off during the verification time and switched on again after the verification time.
- With **Evacuate**, **NAC 1** is switched off during the delay time and only activated during the actual alarm.

Time setting for alarm acknowledgement





	Press zone key 2. This takes you to the Delay Config menu.
	Press zone key 2. This takes you to the Alarm Verific submenu.
	Press zone key 1. This takes you to the ACK Within submenu.
	Use the zone keys to set the respective delay. <ul style="list-style-type: none"> - 1 30 s - 2= 60 s (default setting) - 3 90 s - 4 120s

Time setting for verification time

	Press zone key 2. This takes you to the Delay Config menu.
	Press zone key 2. This takes you to the Alarm Verific submenu.
	Press zone key 2. This takes you to the Invest Time submenu.
	Use the zone keys to set the respective delay. <ul style="list-style-type: none"> - 1 1 min (default setting) - 2 2 min - 3 3 min - 4 4 min

	<ul style="list-style-type: none"> - 5 5 min - 6 6 min - 7 7 min - 8 8 min
--	--

Notification appliance 1

	Press zone key 2. This takes you to the Delay Config menu.
	Press zone key 2. This takes you to the Alarm Verific submenu.
	Press zone key 3. This takes you to the NAC 1 submenu.
	Press zone key 1 or 2. <ul style="list-style-type: none"> - 1 Alert - 2=Evacuate (default setting)

4.2.3 Intermediate Alarm Storage

Intermediate alarm storage is an automatic procedure designed to rule out false alarms as far as possible. The entire procedure lasts up to 60 seconds:

- Ten seconds after a fire is detected, the zone is reset (setting **Reset After**).
- The zone is reset for x seconds (setting **Cut For**, *Cut For*, page 31).
- There is an x second stabilization phase for the elements in the zone (setting **Stabilize For**, *Stabilize for*, page 31).







Caution!

Detectors of the FCP-320 series must not be used with intermediate alarm storage because the detector calculates a new standby value after the reset. This can generate an increased alarm threshold. If there is a fire, this can thus delay the trigger of an alarm.



Before using automatic fire detectors, find out from the manufacturer whether they can be used for intermediate alarm storage.

In this menu you can change the pre-set time values indicated above.

Reset after

	Press zone key 2. This takes you to the Delay Config menu.
	Press zone key 3. This takes you to the Int Alarm Stor submenu.
	Press zone key 1. This takes you to the Reset After submenu.
	Use the zone keys to set the respective delay. <ul style="list-style-type: none"> – 1 1 s – 2 5 s – 3= 10 s (default setting) – 4 15s – 5 20 s

Display total delay



	Press zone key 2. This takes you to the Delay Config menu.
	Press zone key 3. This takes you to the Int Alarm Stor submenu.

	<p>Press zone key 2. This takes you to the Total Delay submenu.</p>
---	--

The total delay is displayed.

4.2.4 Delay for Mains Fault

The **Power Fault** menu option enables you to specify the delay after which an error message indicating a power supply failure (mains or battery) is to be displayed. If the fault is resolved before the time set here, it is no longer displayed.

	<p>Press zone key 2. This takes you to the Delay Config menu.</p>
	<p>Press zone key 4. This takes you to the Power Fault submenu.</p>
	<p>Use the zone keys to set the respective delay.</p> <ul style="list-style-type: none"> - 1=No Delay (default setting) - 2 1 min - 3 5 min - 4 10 min - 5 15 min

4.3 Zone Configuration

In the **Zone Config** menu, you can program the individual zones of the fire panel. Depending on the panel, you can set 2, 4 or 8 zones. The following zone types are available:

No delay (No Delay)

A zone programmed as **No Delay** triggers an alarm immediately. If you are using manual call points, they must be set as **No Delay**.



Notice!

Only use manual call points in zones which are programmed as **No Delay**.

Int Alarm StorIntermediate alarm storage

A zone triggers an alarm. This is evaluated by the fire panel as a pre-alarm and is not displayed. The zone is reset automatically. If it triggers an alarm again, the panel switches immediately to alarm. If a second alarm is not triggered, the fire panel reverts to its normal state after 10 minutes.

Alarm verification (Alarm Verific)

**Notice!**

Note that the delay is only effective in day mode. In night mode, the alarm is triggered immediately.

**Notice!**

If the fire panel automatically switches to night mode during an ongoing verification time, an alarm is triggered immediately.

**Notice!**

If during the verification time in one zone an alarm is triggered in another zone, which is programmed as alarm verification, an alarm is triggered immediately.

If a zone programmed as alarm verification detects an alarm, it triggers an alarm, which is delayed.

The LCD display prompts you to verify the alarm. You must confirm the alarm within a pre-defined time using the ACK key. After this pre-defined time the verification time begins. Within this time you must investigate the alarm triggering area and, if necessary, trigger an alarm.

During the verification time, the panel can be reset without triggering an alarm. After the verification time has expired, the panel goes into the alarm state.

Dual-detector dependency (2-Det Depend)

**Caution!**

Detectors with connected remote displays must not be used with the dual-detector dependency.

Dual-detector dependency only works with detectors that use an alarm resistance of 820 ohm +/- 5% or 910 ohm +/- 5%.

Otherwise, in the event of a fire, proper functioning of the fire panel cannot be guaranteed.

**Notice!**

The fire panel does not support dual-detector dependency with 4-wire detectors.

The zone must contain more than one detector. If one of the detectors in the zone triggers, this is evaluated as a pre-alarm. If an additional detector in the same zone is activated, an alarm is triggered. The panel automatically attempts to reset the pre-alarm every 10 minutes. However, this is not possible if a detector remains active. This procedure is repeated until no more detectors are active and the panel returns to its normal state, or until a second detector becomes active, thus elevating the pre-alarm to an alarm.

Dual-zone dependency (2-Zone Depend)

Applies to adjacent zones, for example zones 1 and 2.



If a zone detects an alarm, this is evaluated as a pre-alarm. An alarm is only triggered when the second zone detects an alarm.

Possible zone dependencies:

- FPC-500-2: 1&2
- FPC-500-4: 1&2, 3&4
- FPC-500-8: 1&2, 3&4, 5&6, 7&8

If you set a zone to dual-zone dependency, the other associated zone is also changed automatically.

Zones 1 to 8

	Press zone key 3. This takes you to the Zone Config menu.
	Press zone key 1. This takes you to the zone 1 submenu.
	Use the zone keys to program the zone. <ul style="list-style-type: none"> – 1=No Delay (default setting) – 2 Int Alarm Stor – 3 Alarm Verific – 4 2-Det Depend – 5 2-Zone Depend

Zones 2 to 8 are pre-programmed in the same way as zone 1.
You can change the settings as with zone 1.



Notice!

Zones 3 and 4 are only available on the FPC-500-4 and FPC-500-8 panels. Zones 5–8 are only available on the FPC-500-8.

4.4 Configuring Inputs

In the **Input Config** menu, you can program the behavior of the inputs.



Notice!

Only use buttons (no locking element) if you have programmed inputs as **Drill/Evacuate**, **Silence**, or **Reset Panel**.
Access levels as per EN 54-2 must be observed.





Notice!

Depending on the panel, there is one input on the FPC-500-2 and FPC-500-4, and two inputs on the FPC-500-8.

	Press zone key 4. This takes you to the Input Config menu.
---	--

4.4.1 Input 1



	Press zone key 4. This takes you to the Input Config menu.
	Press zone key 1. This takes you to the Input 1 submenu.
	Use the zone keys to set the programming for input 1. <ul style="list-style-type: none"> - 1= Not Used (default setting) - 2 Drill/Evacuate - 3 Silence - 4 Level 2 - 5 Reset Panel - 6 Ext PS Fault - 7 Ext Batt Fault



Notice!

You do not have to confirm the input functions on the panel.
Thus use a key switch if possible to activate inputs.

4.4.2 Input 2 (FPC-500-8 only)

	Press zone key 4. This takes you to the Input Config menu.
	Press zone key 2. This takes you to the Input 2 submenu.

Additional settings correspond to those for **Input 1**.

4.5 Configuring Outputs

In the **Output Config** menu, you can program the behavior of the individual fire panel outputs.

4.5.1 Notification Appliances

In the **NAC** submenu, you specify the behavior of the notification appliances. You can use **NAC Zones** to assign the notification appliances to particular zones. **Reactive NAC** specifies whether silenced notification appliances are reactivated by a new alarm in another zone. You can use **NAC in test** to specify whether the notification appliances are activated for 15 seconds when a zone test is performed.





Caution!



When assigning the zones to notification appliances, make sure that each zone of the fire panel is assigned to at least one notification appliance.

Zones not assigned do not trigger any alarm signaling via the notification appliance if there is a fire.

Notification appliance 1 zone assignment





	Press zone key 5. This takes you to the Output Config menu.
	Press zone key 1. This takes you to the NAC submenu.
	Press zone key 1. This takes you to the NAC Zones submenu.
	Use the zone keys to select the corresponding zones whose alarm you want to activate notification appliance 1. You can select multiple zones. If you press the zone key again, the selection is cancelled.

	Confirm your selection.
---	-------------------------





Notification appliance 2 zone assignment

See "Notification appliance 1 zone assignment", *Notification appliance 1 zone assignment*, page 44.

Reactivating notification appliances

	Press zone key 5. This takes you to the Output Config menu.
	Press zone key 1. This takes you to the NAC submenu.
	Press zone key 3. This takes you to the Reactive NAC submenu.
	Press zone keys 1 or 2. 1= By Other Zone (default setting) 2 No Reactivate





Notification appliance behavior in zone test

	Press zone key 5. This takes you to the Output Config menu.
	Press zone key 1. This takes you to the NAC submenu.
	Press zone key 4. This takes you to the NAC in test submenu.
	Press zone keys 1 or 2. 1 Activation 2= No Activation (default setting)





4.5.2 Alarm Relay

In the **Alarm Relay** submenu, you can specify the properties of the alarm relay. These include the **Silencable** and **Drillable** settings. You can use **Silencable** to specify whether the relay can be silenced manually. **Drillable** specifies whether the alarm relay is also activated during a manual alarm (Drill/Evac).

Alarm relay can be muted

	Press zone key 5. This takes you to the Output Config menu.
	Press zone key 2. This takes you to the Alarm Relay submenu.
	Press zone key 1. This takes you to the Silencable submenu.
	Press zone keys 1 or 2. 1 Silencable 2= Not Silencable (default setting)





Alarm relay follows manual alarm

	Press zone key 5. This takes you to the Output Config menu.
	Press zone key 2. This takes you to the Alarm Relay submenu.
	Press zone key 2. This takes you to the Drillable submenu.
	Press zone keys 1 or 2. 1 Drillable 2= Not Drillable (default setting)

4.5.3 OC/Relay Extensions

In the **OC/Relay Ext** menu, you can individually set the properties of all **OC/Relay** outputs. The possible settings for the **OC/Relay** outputs 2 to 8 correspond to those for the first **OC/Relay**. The following settings are possible:

- **Zone = Alarm:** The output is activated if the zone triggers an alarm. Here zone 1 is assigned to output 1, etc.
- **Zone Normal:** If the zone is not in a normal state, the output is activated. Assignment: zone 1 to output 1 etc.
- **Sum Alarm:** When the fire panel is in an alarm state, this output is activated regardless of the zone.
- **Sum PreAlarm:** When the fire panel is in a pre-alarm state, this output is activated regardless of the zone.
- **Sum Fault:** This output is activated if there is a fault.
- **Sum Disable:** If a fire panel element is disabled, this output is activated (zones, notification appliances, relays).
- **Sum Test:** This output is activated if a zone in the fire panel is in test mode.
- **Not Used:** The output is not used.



	Press zone key 5. This takes you to the Output Config menu.
	Press zone key 3. This takes you to the OC/Relay Ext submenu.
	Press zone key 1 to choose Open Collector 1.
	Use the zone keys to make the corresponding setting. <ul style="list-style-type: none"> - 1=Zone = Alarm (default setting) - 2 Zone Normal - 3 Sum Alarm - 4 Sum PreAlarm - 5 Sum Fault

- 6 **Sum Disable**
- 7 **Sum Test**
- 8 **Not Used**

The procedure for **OC/Relay** 2 to 8 is the same.

4.6 Displaying the Configuration



In the **View Config** menu, you can display the programming of the fire panel.

	Press zone key 6. This takes you to the View Config menu.
	Use arrow keys to scroll more quickly through the displayed programming. Hold the arrow key down to scroll through the menu in increments of 10 steps.
	To exit the display, press the ESC key.

4.7 Controlling Outputs



In the **Output Control** menu you can activate and deactivate the individual outputs for test purposes. When you exit operating level 3, all activations of the outputs are reset to the normal state again.

4.7.1 Notification appliance 1



	Press zone key 7. This takes you to the Output Control menu.
	Press zone key 1. This takes you to the NAC 1 submenu.
	- Press the ACK key. Notification appliance 1 is activated.

	<ul style="list-style-type: none"> – Press the RESET key. Notification appliance 1 is deactivated.
--	---



4.7.2 Notification appliance 2

	<p>Press zone key 7. This takes you to the Output Control menu.</p>
	<p>Press zone key 2. This takes you to the NAC 2 submenu.</p>
	<ul style="list-style-type: none"> – Press the ACK key. Notification appliance 2 is activated. – Press the RESET key. Notification appliance 2 is deactivated.

4.7.3 Alarm Relay





	<p>Press zone key 7. This takes you to the Output Control menu.</p>
	<p>Press zone key 3. This takes you to the Alarm Relay submenu.</p>
	<ul style="list-style-type: none"> – Press the ACK key. The alarm relay is activated. – Press the RESET key. The alarm relay is deactivated.

4.7.4 Fault Relay

	<p>Press zone key 7. This takes you to the Output Control menu.</p>
	<p>Press zone key 4. This takes you to the Fault Relay submenu.</p>



	<ul style="list-style-type: none"> – Press the ACK key. The fault relay is activated. – Press the RESET key. The fault relay is deactivated.
---	--

4.7.5 OC/Relay Extension

	<p>Press zone key 7. This takes you to the Output Control menu.</p>
	<p>Press zone key 5. This takes you to the OC/Relay Ext submenu.</p>
	<p>Press zone key 1. This takes you to the OC/Relay 1 submenu.</p>
	<ul style="list-style-type: none"> – Press the ACK key. The OC/Relay 1 output is activated. – Press the RESET key. The OC/Relay 1 output is deactivated.

Continue in the same way for the Open Collector outputs 2 to 8.

4.7.6 Control all outputs

	<p>Press zone key 7. This takes you to the Output Control menu.</p>
	<p>Press zone key 6. This takes you to the All submenu.</p>
	<ul style="list-style-type: none"> – Press the ACK key. All outputs are activated. – Press the RESET key. All outputs are deactivated.



4.8 Resetting To Delivery State

You can use **Config Reset** to reset the programming of the fire panel to the default values set when delivered.



Notice!

Resetting the fire panel deletes all of your changes to the programming. The panel is reset to the default programming, see *Default Settings, page 70*.

	<p>Press zone key 8. This takes you to the Config Reset menu.</p>
	<ul style="list-style-type: none"> - Press the ACK key. The fire panel is reset to the delivery state. - Press the RESET key. You exit the menu without making changes.

5 Fault Diagnosis

Thermal fuse, power supply unit monitoring

The integrated power supply unit is equipped with a thermal fuse. If there is an overload this will switch off the power supply. After the fuse cools off, it will switch the power on again.

There is a green LED on the power supply unit. This flashes when there is an error in the power supply unit.

Thermal fuse, battery monitoring

There is a thermal fuse on the motherboard that monitors the battery current and protects against reverse polarity.

When the fuse cools off, the battery current is switched on again.

Updating the panel software (firmware) via USB

You can update the panel software using the USB port on the lower left side of the main board. To do this, connect the USB port to your computer and install the programming software supplied on the CD. Follow the on-screen instructions.

6 Technical Data

	FPC-500-2	FPC-500-4	FPC-500-8
Zones	2	4	8
Max. number of detectors in accordance with EN 54-2	64	128	256
Max. number of detectors per zone in accordance with EN 54-2	32		
Max. number of extensions	0	1	2
Prog. inputs	1		2
AUX output	1		
Alarm device output	2		
Relay	2		

6.1 Electrical Data

	FPC-500-2	FPC-500-4	FPC-500-8
Power supply voltage	230 VAC +10%/-15%, 50–60 Hz		
Current consumption	275 mA	312 mA	375 mA
AC power consumption	80 W		
Operating voltage	21.4 VDC to 29 VDC		

	FPC-500- 2	FPC-500- 4	FPC-500- 8
I_{\min}	70 mA		
$I_{\max, a}$	0.7 A		
$I_{\max, b}$	2.3 A		
Zones			
– Voltage	20 VDC \pm 1VDC		
– Max. output current	100 mA \pm 5 mA		
– Max. line resistance	22.5 Ohm		
AUX			
– Voltage	21 VDC to 29 VDC		
– Max. output current	500 mA \pm 10%		
– Max. line resistance	22.5 Ohm		
– Fuse	0.75 A @ 60 V		
Notification appliance outputs			
– Voltage	21 VDC to 29 VDC		
– Max. output current	500 mA \pm 10% per output		
– Max. line resistance	22.5 Ohm		
– Fuse	0.75 A @ 60 V		
Relay outputs			
– Breaking capacity	1 A @ 30 VDC		
– Max. line resistance	22.5 Ohm		
Transistor outputs			
– Breaking capacity	No inductive loads 20 mA @ 24 VDC		
– Max. line resistance	22.5 Ohm		
Recommended cable type	Unshielded cable, 0.8-mm cable diameter, cable cross section up to 1.5 mm ²		
Batteries			
– Max. inner resistance	800 mOhm		
– Max. current consumption	2.3 A		

	FPC-500-2	FPC-500-4	FPC-500-8
- Fuse	5 A @ 60 V		
End-point voltage	21.4 V		

6.1.1 Communication parameters

	FPC-500-2	FPC-500-4	FPC-500-8
Notification appliances			
Standby			
- A-	10 V to 15 V		
- B+	0 V to 0.5 V		
Alarm state			
- A-	0 V to 1 V		
- B+	21 V to 29 V		
Inputs			
- Alarm resistor	820 ohm $\pm 5\%$		
- EOL Resistor	3900 ohm $\pm 1\%$		
Zones (with resistance combination)			
- Alarm resistor	820 ohm $\pm 5\%$ 910 ohm $\pm 5\%$ No 2-Det Depend : 680 ohm $\pm 5\%$		
- EOL Resistor	3900 ohm $\pm 1\%$		
Zones (with EOL modules)			
- Alarm resistor	820 ohm $\pm 5\%$ 910 ohm $\pm 5\%$ No 2-Det Depend : 680 ohm $\pm 5\%$		

6.2 Mechanical

	FPC-500-2	FPC-500-4	FPC-500-8
Dimensions (H x W x D)	351 x 351 x 90 mm		
Weight	2200 g, without batteries		
Housing material			
– Front	ABS+PC		
– Back	ABS-FR		
Housing color			
– Front	RAL 9003 (Signal White)		
– Back	PANTONE 10 C (Cool Grey)		

6.3 Environmental Conditions

	FPC-500-2	FPC-500-4	FPC-500-8
Protection category according to EN 60529	IP 30		
Protection class as per EN 60950	II		
EMC interference immunity, emissions	EN 61000-6-3		
EMC interference immunity	EN 50130-4		
Vibrations	EN 60068-2-6		
Permitted operating temperature	0 °C to +40 °C		
Permitted storage temperature	-10 °C to +55 °C (14 °F to 131 °F)		
Relative humidity	Max. 95% non-condensing		

6.4 Information as per EN 54-4, chapter 7.1

- a) This is a power supply unit that is installed in the FPC-500 Fire Panel. It provides power to the device and the connected peripherals and is used to charge the two connectable batteries.
- b) Technical data

1) Recommended power output	61 W
2) Power supply	230 VAC +10%/-15%, 50–60 Hz
Operating voltage	26 VDC to 29 VDC
3) Communication parameters	None
4) Fuse values	3.15 A/250 V
5) Batteries	2 x 7.0–7.2 Ah (max.) lead gel battery
6) Max. current consumption	2.3 A
7) Max. battery inner resistance	800 mOhm
8) I_{\min}	70 mA
$I_{\max, a}$	0.7 A
$I_{\max, b}$	2.3 A
9) Cable parameters	
Battery	Cable enclosed
Board power supply	Wired ex works
230-V power supply	1.5-mm ² standard cable

c) The power supply unit is a component of the FPC-500 Fire Panel and is supplied preinstalled. No additional installation instructions are necessary.

1) Please refer to the information on environmental conditions in this document.

2) The power supply unit is supplied preinstalled – assembly instructions are not required.

3) For connection instructions, please refer to the FPC-500 installation instructions.

d) The power supply unit is a component of the FPC-500 Fire Panel – there are no additional operating instructions.

e) The power supply unit is a component of the FPC-500 Fire Panel – no operation is required.

f) Have maintenance and installation work carried out regularly by trained, qualified personnel. Bosch Sicherheitssysteme GmbH recommends carrying out a functional and visual check at least once a year. Replace the batteries on a regular basis. Please observe the appropriate requirements stipulated by the local authorities etc.

6.5 Options with requirements as per EN 54-2:1997/A1:2006

The FPC-500 provides the following options with requirements under EN 54-2:1997/A1:2006

- Alarm counter
- Test status
- Output for activation of fire alarm devices
- Transmission delay
- Dependency of fire detection status on more than one alarm signal
 - Type A dependency
 - Type B dependency

7 Appendix

7.1 Brief Overview, Operating Level 1 and 2

		Submenu				
		1	2	3		
Menu operating level 1 and 2						
Ⓢ	1	Current Events	1	Faults	-	-
			2	Disablements	-	-
			3	Test	-	-
			4	PreAlarm	-	-
	2	History	1	Event History	-	-
			2	Test History	-	-
	3	Alarm Counter	-	-	-	-
	4	System Info	1	SW Release	-	-
			2	Operation Days	-	-
	Menu operating level 2 – code required					
Ⓢ	5	View Config	-	-	-	-
	6	System Config	1	Date/Time	-	-
			2	Keypad Tone	1	On
					2	Off
	3	Language	1	1-A - L		
			2	2-M - Z		

7.2 Test menu

		Submenu				
		1	2	3		
Test menu						
	1	Test MMI	-	-	-	-
	2	Test Zones	1	Zone 1	-	-
			2	Zone 2	-	-
			3	Zone 3	-	-
			4	Zone 4	-	-
			5	Zone 5	-	-
			6	Zone 6	-	-
			7	Zone 7	-	-
			8	Zone 8	-	-
	3	Dis/Enable	1	Zones	1	Zone 1
					2	Zone 2
					3	Zone 3
					4	Zone 4
					5	Zone 5
					6	Zone 6
7					Zone 7	
8					Zone 8	
2			NAC	ACK =YES ESC=No		
3			Relays	ACK =YES ESC=No		
4			All	ACK =YES ESC=No		

7.3 Brief Overview, Operating Level 3

		Submenu			
		1	2	3	
1 - System Config					
1	1	Date/Time			
	2	Keypad Tone	1 On	-	-
			2 Off	-	-
	3	EOL Devices	1 Resistor	-	-
			2 Only 2W Module	-	-
			3 With 4W Module	-	-
	4	Zone Reset	1 Cut For	1	1 s
				2	5 s
				3	10 s
				4	15 s
				5	20 s
			2 Stabilize For	1	1 s
				2	5 s
				3	10 s

Submenu				
1		2		3
				15 s
				4
				20 s
				5
5		1	With Zone	- -
		2	With Panel	- -
		3	Never	- -
6		1	Latching	- -
		2	Non Latching	- -
7		1	Level Code 2	- -
		2	Level Code 3	- -
8		1	Log Enabled	- -
		2	Log Disabled	- -

Submenu					
1		2		3	
2 - Delay Config					
2	1		Day Mode Off		
			1	Manual	- -
			2	Automatic	
				Off Time: : 17:00	
	2		Alarm Verific	1	
				1	ACK Within
				2	60 s

Submenu		
1	2	3
		90 s 3
		120 s 4
	Invest Time 2	1 min Delay 1
		2 min Delay 2
		3 min Delay 3
		4 min Delay 4
		5 min Delay 5
		6 min Delay 6
		7 min Delay 7
		8 min Delay 8
	NAC 1 3	Alert 1
		Evacuate 2
Int Alarm Stor 3	Reset After 1	1 s 1

Submenu				
1		2		3
				5 s
				2
				10 s
				3
				15 s
				4
				20 s
				5
		Total Delay		- -
		2		
4	Power Fault	No Delay		- -
		1		
		1 min Delay		- -
		2		
		5 min Delay		- -
		3		
		10 min Delay		- -
		4		
		15 min Delay		- -
		5		

Submenu				
1		2		3
3 - Zone Config				
3	Zone 1	No Delay		- -
	1	1		

Submenu				
1		2		3
		2	Int Alarm Stor	- -
		3	Alarm Verific	- -
		4	2-Det Depend	- -
		5	2-Zone Depend	- -
2	Zone 2	1	No Delay	- -
3	Zone 3	No Delay (FPC-500-4 /-8)		
4	Zone 4	No Delay (FPC-500-4 /-8)		
5	Zone 5	No Delay (FPC-500-8)		
6	Zone 6	No Delay (FPC-500-8)		
7	Zone 7	No Delay (FPC-500-8)		
8	Zone 8	No Delay (FPC-500-8)		
4 - Input Config				
4	Input 1	1	Not Used	- -

Submenu		
1	2	3
	2 Drill/Evacuate	- -
	3 Silence	- -
	4 Level 2	- -
	5 Reset Panel	- -
	6 Ext PS Fault	- -
	7 Ext Batt Fault	- -
2 Input 2	See Input 1 (FPC-500-8)	

Submenu		
1	2	3
5 - Output Config		
5 1 NAC	1 NAC Zones 1	- -
	2 NAC Zones 2	- -
	3 Reactive NAC	1 By Other Zone
		2 No Reactivate



Submenu		
1	2	3
	4	NAC in test
		Activation
2	1	No Activation
		2
	1	Silencable
		Silencable
		Not Silencable
		2
2	Drillable	
	Drillable	
1	Not Drillable	
	2	
3	1	OC/Relay Ext
		OC/Relay 1
		Zone = Alarm
		1
		Zone Normal
		2
		Sum Alarm
		3
Sum PreAlarm		
4		
Sum Fault		
5		
Sum Disable		
6		
Sum Test		
7		





Submenu					
1		2		3	
				8	Not Used
		2	OC/Relay	See OC/Relay 1	
		3	OC/Relay	See OC/Relay 1	
		4	OC/Relay	See OC/Relay 1	
		5	OC/Relay	See OC/Relay 1	
		6	OC/Relay	See OC/Relay 1	
		7	OC/Relay	See OC/Relay 1	
		8	OC/Relay	See OC/Relay 1	
6 - View Config					

Submenu					
1		2		3	
7 - Output Control					
7	1	NAC 1	ACK =On ESC=Off	-	-
	2	NAC 2	ACK =On ESC=Off	-	-
	3	Alarm Relay	ACK =On ESC=Off	-	-

Submenu			
1	2	3	
4	Fault Relay	ACK =On ESC=Off	- -
5	OC/Relay Ext	1 OC/Relay 1	ACK =On ESC=Off
		2 OC/Relay 2	ACK =On ESC=Off
		3 OC/Relay 3	ACK =On ESC=Off
		4 OC/Relay 4	ACK =On ESC=Off
		5 OC/Relay 5	ACK =On ESC=Off
		6 OC/Relay 6	ACK =On ESC=Off
		7 OC/Relay 7	ACK =On ESC=Off
		8 OC/Relay 8	ACK =On ESC=Off
6	All	ACK =On ESC=Off	- -
8 - Config Reset			

Navigation in the menu

	Press the arrow key to scroll up in the menu.
	Press the arrow key to scroll down in the menu.

	Press the ACK key to confirm your selection.
	Press the ESC key to exit the selection without making a change or to jump up a menu level.
	Hold the ESC key down for 2 seconds to jump to the uppermost menu level.
	In the menu, each menu item has a number from 1 to 8 preceding it. Use the zone keys to select the desired menu item in the menu.

7.4 Default Settings

Menu item			Default setting	
1 System Config				
	2 Keypad Tone		On	
	3 EOL Devices		Resistor	
	4 Zone Reset			
		1 Cut For	5 s	
		2 Stabilize For	5 s	
	5 Aux Power		With Zone	
	6 Faults		Latching	
	8 Test History		Log Enabled	
2 Delay Config				
	1 Day Mode Off		Manual	
	2 Alarm Verific			
		1 ACK Within	60 s	
		2 Invest Time	1 min	
		3 NAC 1	Evacuate	
	3 Int Alarm Stor			
		1 Reset After	10 s	
	4 Power Fault		No Delay	
3 Zone Config				
	1 Zone 1		No Delay	
	...			
4 Input Config				

Menu item			Default setting	
	1 Input 1		Not Used	
	...			
5 Output Config				
	1 NAC			
		1 NAC Zones	All zones	
		2 NAC Zones	All zones	
		3 Reactive NAC	By Other Zone	
		4 NAC in test	No Activation	
	2 Alarm Relay			
		1 Silencable	Not Silencable	
		2 Drillable	Not Drillable	
	3 OC/Relay Ext			
		1 OC/Relay 1	Zone = Alarm	

7.5 Event Memory

Message	Meaning
Drill/Evacuate	A manual alarm has been triggered on the panel.
Zone Alarm	Zone # has triggered an alarm.
Zone PreAlarm	Zone # has triggered a pre-alarm.
Zone Open	Zone # is interrupted.
Zone Short	Zone # has a short-circuit.
Zone Normal	Zone # is in the normal state. (Fault or alarm eliminated)
Zone Disabled	Zone # was enabled.
Zone Enabled	Zone # was enabled.
Input Open	Input # interrupted.
Input Short	Input # short-circuit.
Input Normal	Input # normal.
Aux Power Short	Short-circuit in the AUX power supply
Aux Power Normal	Error in the AUX power supply eliminated.
NAC Open	Notification appliance #, line interrupted
NAC Short	Notification appliance #, short-circuit on line.
NAC Normal	Notification appliance # normal. (Fault was eliminated)
NAC Enabled	Notification appliances re-enabled.
NAC Disabled	Notification appliances disabled.
Relays Enabled	Relays re-enabled.

Message	Meaning
Relays Disabled	Relays disabled.
Battery Fault	Fault in the battery power supply.
Battery Restore	Battery power supply was restored.
Mains Fault	Fault in the 230 V power supply.
Mains Restore	230 V power supply was restored.
Sys Load Fault	Current consumption of panel and all connected peripherals is above 3.5 A.
Sys Load Normal	Current consumption is back in permitted range.
System Fault	System fault
Panel boot-up	Panel has been restarted.
Reset Panel	Panel has been reset.
Night Mode	Panel has switched to night mode.
Day Mode	Panel has switched to day mode.
Earth Fault	Grounding fault.
Earth Normal	Fault in grounding resolved.
Level Enter	Operating level # entered.
Level Exit	Operating level # exited.
Silenced	An alarm has been silenced.
Unsilenced	A silenced alarm has been reactivated.

7.6 Test Memory Messages

Message	Meaning
Zone Start	Zone # set to test mode.
Zone Test	Zone # successfully tested.

Message	Meaning
Zone End	Zone # test mode exited.

Index

A

Access model	11
Alarm relay	
Programming	46
AUX;Reset settings	32

B

Buzzer beep	
Setting	29

C

Cable entries	12
Code	
Change;Password:Change	33
Code;Password	26
Confirmation time	
Setting	35

D

Date/Time	
Setting	29
Default settings	70
Delay	
Power supply fault;Power supply:Fault delay	39
Delay settings	34

E

Emergency power supply;Batteries	15
Extensions	17

F

Fault handling;Store faults	32
-----------------------------	----

H

Housing	
Installing	13
Open	13

I

Input	19
Programming a function	43
Installation location	12
Intermediate alarm storage	
Setting	37
Invest time	
Setting	36

M

Mains supply	14
--------------	----

N

Navigating	
Arrow keys	29
Navigation	68
Zone keys	28, 69
Notification appliance	23
Assignment to zones	44
Behavior in zone test	45
Specifying reactivation	45

O

Operating level 3	
Automatic exit	27
Calling up	26
Exiting	27

Operation	28	Zone types	39
Outputs		dual-detector	
Activation for testing	48	dependency;dual-detector	
Programming	44	dependency	41
Programming;Transistor		Dual-zone dependency;dual-	
outputs:Programming;Relay		zone dependency	41
outputs:Programming	47	Intermediate alarm	
P		storage;Intermediate alarm	
Programming		storage	40
Resetting to delivery state	51	Manual alarm	
R		verification;Manual alarm	
Relay outputs;Alarm relay;Fault		verification	40
relay	24	No delay;No delay	39
S		Zones	
Screw terminals	18	Specify zone type	42
Submenus			
Exiting	29		
T			
Terminal resistance;Terminal			
element;EOL module;End-Of-			
Line module	19, 20		
Test log			
Setting	34		
Z			
Zone reset			
Disconnection duration	31		
Setting times	31		
Stabilization time	31		
Zone termination			
Setting	30		



Bosch Sicherheitssysteme GmbH

Robert-Bosch-Ring 5

85630 Grasbrunn

Germany

www.boschsecurity.com

© Bosch Sicherheitssysteme GmbH, 2020