

FLEXIDOME panoramic 5100i



- ▶ 360° panoramic overview in 6MP and 12MP sensor resolution without blind spots
- ▶ High Dynamic Range to see every detail in both bright and dark areas of the scene
- ▶ Edge or client-side dewarping for easy integration and flexible viewing and recording
- ▶ Built-in IVA Pro Buildings, IVA Pro Perimeter and Intelligent Audio Analytics to trigger relevant alerts and quickly retrieve data
- ▶ Compact design for unobtrusive indoor use with quick and easy installation and set-up

The FLEXIDOME panoramic 5100i is a discreet and aesthetic panoramic camera for indoor surveillance. Its stereographic, panoramic lens provides full 360° coverage without blind spots, ideal for surveillance applications that require wide area coverage in a single, detailed view. The camera offers full situational awareness and simultaneous high-resolution zoomed-in images. The high-end system on chip (SoC) provides dewarping for easy integration and flexible viewing and recording. Built-in Intelligent Video Analytics Pro (IVA Pro) enriches full situational awareness and triggers relevant alerts.

Intelligent Audio Analytics gives meaning to the sounds it captures.

With its HDMI output function, it can be directly connected to a Public View Monitor, making it a perfect fit for a retail environment.

Functions

Up to 12MP sensor resolution

The camera offers a choice between a 6MP or 12MP sensor to optimize for the amount of details required. Both options offer 30 fps to ensure real-time motion in your scenes.

Taking into account the image circle projection, the cameras offer a 4.5MP and 9MP effective resolution. Combined with the stereographic lens in these cameras it also provides improved resolution in the peripheral areas of the image.

Panoramic vision and Intelligent Video Analytics Pro (IVA Pro)

Combining Bosch Intelligent Video Analytics Pro (IVA Pro) software with full panoramic vision, produces an extremely powerful surveillance tool, which enriches full situational awareness. With intelligent tracking, movement can be followed continuously throughout the full image circle. There is no need to hand off tracking from one camera to another, greatly simplifying movement analysis.

The system reliably detects, tracks, and analyzes objects, and alerts you when predefined alarms are triggered. A smart set of alarm rules makes complex tasks easy and reduces false alarms to a minimum. Moving objects can be classified in four different object classes: person, car, bike, truck. Calibration is quick and easy -IVA Pro Perimeter in 3D tracking mode only requires entering the mounting height of the camera. The internal gyro/accelerometer sensor provides the rest of the information to precisely calibrate the video analytics. For IVA Pro Buildings effort is minimized, eliminating the need for calibration.

Camera Trainer

Based on examples of target objects and non-target objects, the Camera Trainer program uses machine learning to allow the user to define objects of interest and generate detectors for them. In contrast to the moving objects that the Intelligent Video Analytics application detects, the Camera Trainer

program detects both moving and non-moving objects and classifies them immediately. Using Configuration Manager, you can configure the Camera Trainer program using both live video as well as recordings available through the respective camera. The resulting detectors can be downloaded and uploaded for distribution to other cameras. A free of charge license is required to activate the Camera Trainer program.

Intelligent Audio Analytics

The device has an integrated microphone array with three digital microphones for Intelligent Audio Analytics. This is a powerful AI-driven audio signal processing algorithm built to detect and identify target sounds from the ambient sound. It is powered by SoundSee technology and developed to improve operations of the International Space Station (ISS). A set of sound detectors identify sound events such as gunshot (perpetual license) and T3 / T4 alarms (pre-installed). The sound detectors trigger an alarm functionality to alert the operator when the sound event matches an audio signature of a sound detector. Without the need to record audio, Intelligent Audio Analytics generates metadata that is seamlessly integrated with Bosch' Intelligent Video Analytics metadata stream.

The device is not only able to classify sounds, but also to provide an approximate location of the sound. If required by local laws, the microphone can be permanently blocked via a secure license key. As Intelligent Audio Analytics is under development, the available Sound Detectors and features will dependent on the camera FW version.

Dewarping

The lens captures a circular image. Our dewarping software transforms this circular image into several different distortion-free rectangular views. To facilitate system integration, you can choose edge dewarping inside the camera or client-side dewarping on an external platform.











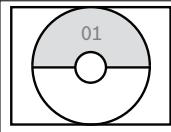

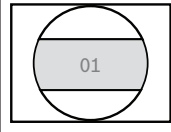

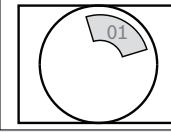
The edge dewarping in the camera provides three separate video channels simultaneously:

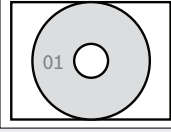
- Full image circle (Video 1 channel)
- Dewarped view mode (Video 2 channel)
- E-PTZ (Video 3 channel)

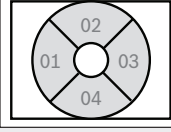
Different view modes can be selected for the video 2 channel. Your selection depends on the resolution you require and how you wish to view the dewarped image.

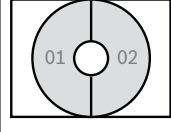
View modes

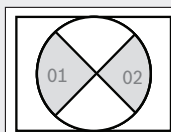
The following view modes can be select in the camera or on the client:

	Full image cut-out and displayed image	
Panoramic view (ceiling mount)		
Panoramic view (for 180° wall mount)		
E-PTZ view		
Full panoramic view		
Quad view		
Double panoramic view		
Corridor view (ceiling mount)		

HDMI output

The camera has HDMI output up to 1080p resolution for live streaming to a public view monitor, ideal for retail usage or for local video display. Via its micro HDMI connector, the camera can display the full image circle.

It also offers the flexibility to display both warped and dewarped images, including quad view and ePTZ.

High Dynamic Range

The camera has High Dynamic Range. This is based on a multiple-exposure process that captures more details in the highlights and in the shadows even in

the same scene. The result is that you can easily distinguish objects and features, for example, faces with bright backlight.

The actual dynamic range of the camera is measured using Opto-Electronic Conversion Function (OECF) analysis according to IEC 62676 Part 5. This method is used to provide standardized measurements, which can be used to compare different cameras.

DORI coverage

DORI (Detect, Observe, Recognize, Identify) is a standard system (EN-62676-4) for defining the ability of a person viewing the video to distinguish persons or objects within a covered area. The maximum distance at which a camera/lens combination can meet these criteria is shown below:

When mounted at 3 m (10 ft) height the camera has the following coverage radius for the four DORI levels for a person in the scene:

DORI	DORI definition	Coverage radius
Detect	25 px/m (8 px/ft)	12MP: 45.5 m / 149 ft 6MP: 28 m / 93 ft
Observe	63 px/m (19 px/ft)	12MP: 18 m / 60 ft 6MP: 11.5 m / 38 ft
Recognize	125 px/m (38 px/ft)	12MP: 8.5 m / 28 ft 6MP: 5.5 m / 18 ft
Identify	250 px/m (76 px/ft)	12MP: 3.8 m / 13 ft 6MP: 2.1 m / 7 ft

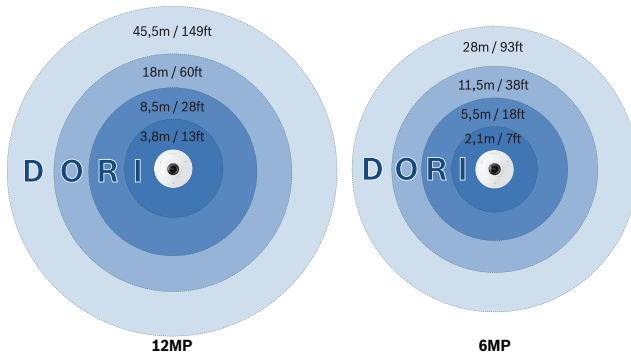

E-PTZ and regions of interest

The remote E-PTZ (Electronic Pan, Tilt and Zoom) controls allow you to select specific areas of the full image circle. With onboard dewarping enabled, these Regions of Interest (ROI) can be easily defined, allowing the most interesting part of a scene to be monitored separately. The high resolution ensures that details are not lost even when using the electronic zoom.

The E-PTZ feature of a panoramic camera has some advantages over normal PTZ cameras. There is no camera movement so the camera does not draw attention to itself or appear intrusive. Situational awareness is still retained even when zooming in on

a particular object of interest. The smooth E-PTZ function helps navigation, and presets are available for setting up a guard tour.

Intelligent tracking is also available to track people through the entire view of the camera.

Record exactly what you want

The camera provides the full resolution circular image for recording even if you are viewing only a portion of the scene. This means that you can always perform retrospective dewarping and analysis on the complete area covered and then zoom in on the region or object of interest.

With edge-dewarping you can also choose to only record the relevant parts of the scene which helps reduce bitrates significantly.

Scene modes

The camera has a very intuitive user interface that allows fast and easy configuration. Multiple preset configurable modes are provided with the best settings for a variety of applications. Different scene modes can be selected for different situations, such as sodium lighting or dark environments.

Edge recording

Insert a memory card into the card slot to store up to 2 TB of local alarm recording. Pre-alarm recording in RAM reduces recording bandwidth on the network, and extends the effective life of the memory card. It has advanced edge recording providing a reliable storage solution possible due to the combination of these functions:

- Industrial SD card support allows for extreme lifetime
- Health monitoring of industrial SD cards provide early service indications.

Health monitoring will be available with a future firmware version.

Data security

Special measures have been put in place to ensure the highest level of security for device access and data transport. The three-level password protection with security recommendations allows users to customize device access. Web browser access can be protected using HTTPS and firmware updates can also be protected with authenticated secure uploads. The cameras have built-in Secure Element (SE) hardware providing main Trusted Platform Module (TPM) functionality to ensure the highest levels of data security and privacy protection. Together with Public Key Infrastructure (PKI) support, superior protection from malicious attacks is guaranteed. It also supports 802.1x network authentication with EAP/TLS and RSA encryption key lengths of up to 4096 bits, ensuring data safety beyond 2030. The advanced certificate handling offers:

- Bosch origin device certificate pre-installed
- Self-signed unique certificates automatically created when required
- Client and server certificates for authentication

- Client certificates for proof of authenticity
- Certificates with encrypted private keys

Modular accessories

A full line of modular accessories is available that allows a consistent design across different cameras and a wide range of installation possibilities. Available options include wall or pipe mount, a surveillance cabinet with power and fiber optic options, and an in-ceiling mounting kit.

Intelligent streaming

Smart encoding capabilities, utilizing video analytics, reduce bandwidth consumption to extremely low levels. Only relevant information in the scene, such as motion or objects found through analytics, needs to be encoded. The camera is capable of quad streaming, allowing it to deliver independent and configurable streams for live viewing, recording, or remote monitoring via constrained bandwidths. Each of these streams can be adapted independently to deliver high-quality video, perfectly tailored to purpose, while reducing bit rate by up to 90% compared to a standard camera.

Cloud-based services

Using the Bosch Security Cloud, you can configure, troubleshoot, and update supported devices using the browser-based interface or standard tools. With one click on Remote Portal, you can activate additional value-added services, such as Alarm Management in Cloud VMS, or VideoView+. VideoView+ provides an easy-to-use and cost-effective solution to remotely connect to your device from anywhere, at any time. Leverage the power of the Bosch cloud to monitor your premises and get notified about any incident. VideoView+ also enables live streaming, locally and from remote, of up to 8 concurrent devices via Video Security Client, or of up to 4 concurrent devices on the Android and iOS app clients. This includes replay and export functionality, as well as forensic search to define and perform search criteria for recorded events.

Bosch Remote Portal

With the secure cloud infrastructure, Remote Portal, you can manage your connected Bosch devices. From the Remote Portal you can:

- Complete initial configuration of your connected Bosch devices (online or offline).
- Update firmware for single or multiple devices.
- Manage certificates.
- Monitor the health of your connected Bosch devices.

System integration and ONVIF conformance

The camera conforms to the ONVIF Profile S, ONVIF Profile G, ONVIF Profile M, and ONVIF Profile T specifications. For H.265 configuration, the camera supports Media Service 2, which is part of ONVIF Profile T. Compliance with these standards guarantees interoperability between network video products regardless of manufacturer.

Third-party integrators can easily access the internal feature set of the camera for integration into large projects. Visit the Bosch Integration Partner Program (IPP) website (ipp.boschsecurity.com) for more information.

Regulatory information

Standards	Type
Emission	EN 55032 EN 50121-4 CFR 47 FCC part 15, Class A
Environmental	EN IEC 63000: 2018 EN 50130-5: 2011 RoHS EU, 2011/65/EU and 2015/863/EU WEEE EU, 2012/19/EU
Immunity	EN 50130-4
Marks	CE, FCC, UL, WEEE, RCM, VCCI, CMIM, UKCA, China RoHS, BIS
Safety	EN 62368-1 UL 62368-1, 3rd edition CAN/CSA-C 22.2 No. 62368-1-14, 3rd edition
Image performance	IEC 62676-5
ONVIF conformance	EN 50132-5-2, EN 62676-2

Region	Regulatory compliance/quality marks	
Europe	CE	
Global	IEC 62443	Industrial Cyber Security Capability
USA	UL CAP	Cybersecurity Assurance Program
Great Britain	UKCA	

Installation/configuration notes

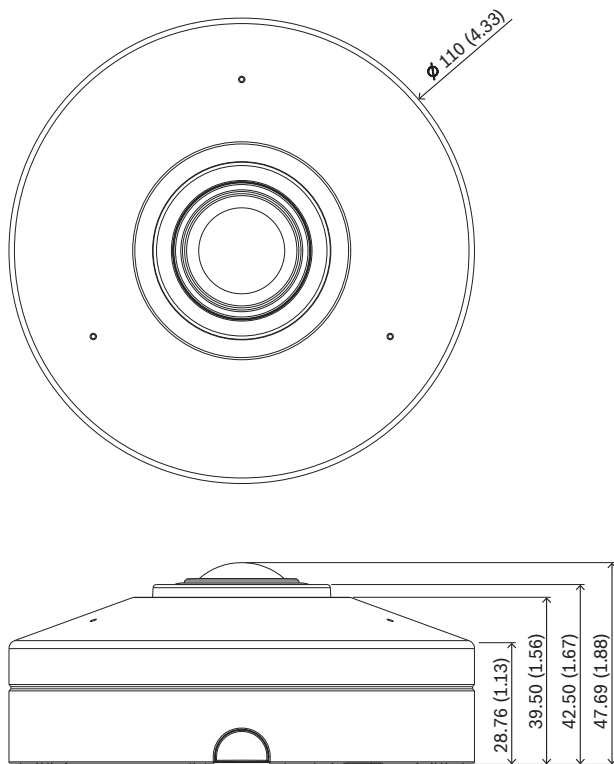

Dimensions in mm (inch)

Technical specifications

Electrical

PoE input	PoE IEEE 802.3af Type 1, Class 2
Power consumption PoE (W) (typical – maximum)	5.6 W – 6 W

Sensor

	6 MP
Total sensor pixels	6 MP approx.
Sensor type	1/1.8 inch CMOS
Effective pixels (H x V)	2,112 x 2,112 (4,5 MP)
	12 MP
Total sensor pixels	12 MP approx.
Sensor type	1/2.3 inch CMOS
Effective pixels (H x V)	3,008 x 3,008 (9 MP)

Sensitivity

	6 MP
Color (lx) (sensitivity measured according to IEC 62676 Part 5)	0.0990 lx
Monochrome (lx) (sensitivity measured according to IEC 62676 Part 5)	0.0080 lx
High Dynamic Range (HDR) (dB)	120 dB
Measured according to IEC 62676 Part 5 (dB)	105 dB
	12 MP
Color (lx) (sensitivity measured according to IEC 62676 Part 5)	0.15 lx
Monochrome (lx) (sensitivity measured according to IEC 62676 Part 5)	0.0480 lx
High Dynamic Range (HDR) (dB)	120 dB
Measured according to IEC 62676 Part 5 (dB)	106 dB

Optical

	6 MP
Lens	1.155 mm fixed-focus lens
Lens mounting	Board
Lens aperture (/F)	2.0 /F
Iris control	Fixed iris
Day / Night	Switchable IR-cut filter
Field of View fixed lens (°)	182° x 182°
Minimum object distance	0.1 m
	12 MP
Lens	1.26 mm fixed-focus lens
Lens mounting	Board
Lens aperture (/F)	2 /F
Iris control	Fixed iris
Day / Night	Switchable IR-cut filter
Field of View fixed lens (°)	182° x 182°
Minimum object distance	0.1 m

Video streaming

Video compression	H.264 (ISO/IEC 14496-10); M-JPEG; H.265/HEVC
Streaming	Multiple configurable streams in H.265; H.264 and M-JPEG; Configurable framerate and bandwidth; Region of Interest (ROI); Multiple channels with edge dewarping
Overall IP delay	Min. 120 ms, Max. 340 ms
GOP structure	IP; IBP; IBBP
Frame rate (fps)	1 fps – 30 fps
Encoder regions	Eight independent areas for setting encoder quality to optimize bitrate

Video resolution (H x V)

Video 1 channel	Full image circle	6 MP: 2112 x 2112 (4.5 MP) 12 MP: 3008 x 3008 (9 MP)
Video 2 channel	Various dewarped modes (Full panoramic, double panoramic, quad, corridor, E-PTZ)	Resolution depends on selected dewarped mode
Video 3 channel	E-PTZ	Up to 1920 x 1080

Multiple lower resolutions available and individually selectable per channel and stream

Video functions

Shutter modes	Automatic Electronic Shutter (AES); 1/15,000 max; Default shutter (1/30 [1/25] to 1/500) selectable; Max. shutter speed 1/1.875 to 1/150000
Day/night modes	Auto (adjustable switch points); Color; Monochrome
Backlight compensation	On/Off
Camera functionality	Geolocation; Region of interest; Audio detection; Backlight compensation (BLC); Intelligent dynamic noise reduction; Contrast enhancement; Sharpness enhancement; Intelligent defog; Pixel counter; Tamper detec-

	tion; Saturation; Brightness; Video watermarking; Display stamping; Location
White balance (K)	2,500 K – 10,000 K
White balance modes	3 automatic modes (Basic, Standard, Sodium vapor); Manual mode; Hold mode
Number of privacy masks	8 independent areas, fully programmable
Number of pre-positions	6 independent sectors
Scene modes	Multiple default modes with scheduler
Guard tours	Pre-position tour consisting of up to six scenes, consecutively
Display stamping	Individual names and stamps for all video channels

Video content analysis

Analysis type	Camera trainer; Intelligent Video Analytics Pro: IVA Pro Buildings; Intelligent Video Analytics Pro: IVA Pro Perimeter
Alarm triggers	Any object; Object in field; Line crossing; Enter / leave field; Loitering; Follow route; Idle / removed object; Counting; Occupancy; Condition change; Similarity search
Object filters	Duration; Size; Aspect ratio; Direction; Color; Object classes
Object classes	IVA Pro Buildings: Person, Vehicle IVA Pro Perimeter: Bicycle, Motorcycle, Truck, Bus
Tracking modes	IVA Pro Buildings: Base tracking (2D) IVA Pro Perimeter: Perimeter tracking (2D); Perimeter tracking (3D); People tracking (3D); Museum mode (2D); Ship tracking (2D)
Calibration	IVA Pro Buildings: No calibration

	IVA Pro Perimeter: Automatic based on gyro sensor, focal length, and camera height (for 3D tracking)
Supported analysis	IVA Pro Privacy (Free)
Audio AI	T3 / T4 alarm detection (pre-installed) Gunshot detection (licensed)

Storage

Internal storage	5-s-pre-alarm-recording
Memory card slot	Micro SDXC; SDHC; SD
Industrial SD cards	Extreme lifetime and health monitoring support that provides early service indication (if supported by the DS card) Health monitoring will be available with a future firmware version.

Inputs and outputs

HDMI output	Micro HDMI connector and up to 1080p resolution with dewarped viewing possibilities
Microphone	Integrated array with 3 digital MEMS audio sensors
Ethernet	RJ-45

Audio

Compression and sampling rate	G.711 8 kHz; L16 16 kHz; AAC-LC, 96 kbps at 32/48 kHz
Audio input	Built-in microphone
Minimum signal-to-noise ratio (dB)	>50 dB
Audio streaming	Full duplex; Half duplex

Network

Protocols / standards	IPv4; IPv6; UDP; TCP; HTTP; HTTPS; RTP/RTCP; IGMP V2/V3; ICMP; ICMPv6; RTSP; FTP; ARP; DHCP; APIPA (Auto-IP, link local address);

	NTP (SNTP); SNMP (V1, MIBII); SNMP (V3, MIBII); 802.1x, EAP/TLS; DNS; DNSv6; DDNS (DynDNS.org, selfHOST.de, no-ip.com); SMTP; iSCSI; UPnP (SSDP); DiffServ (QoS); LLDP; SOAP; CHAP; Digest authentication
Ethernet type	10/100BASE-T; 10/100/1000BASE-T; Auto-sensing; Full / half duplex
Connectivity	Auto-MDIX
Conformity	ONVIF Profile S; ONVIF Profile G; ONVIF Profile T; ONVIF Profile M

Platform

Common Product Platform	CPP14
Memory (RAM) (MB)	2,048 MB; 8,192 MB flash

Data security

Crypto coprocessor (TPM)	RSA 4096 bit; AES/CBC 256 bit
PKI	X.509 certificates; SCEP protocol
End-to-end encryption	Full end-to-end with supported VMS
Encryption	TLS1.2; TLS 1.3; AES 128; AES 256
Local storage encryption	XTS-AES
Video authentication	MD5; SHA-1; SHA-256; SHA-512; Checksum
Firmware protection	Signed firmware, secure boot

Mechanical

Material	Polycarbonate housing
Lens adjustment (rotation)	355°
Dimensions (Ø x H) (mm)	110 mm x 47.70 mm
Dimensions (Ø x H) (in)	4.33 in x 1.88 in
Gyroscope	Yes
Weight (kg)	0.31 kg

Weight (lb)	0.68 lb
Color (RAL)	RAL 9003 Signal white
Mounting type	Surface-mounted
Environmental	
Operating temperature (°C)	-10 °C to +45 °C
Operating temperature (°F)	14 °F to 113 °F
Storage temperature (°C)	-40 °C – 70 °C
Storage temperature (°F)	-40 °F – 158 °F
Cold start temperature (°C)	0 °C
Cold start temperature (°F)	32 °F
Operating relative humidity, non-condensing (%)	5% – 93%
Operating relative humidity, condensing (%)	5% – 100%
Storage relative humidity (%)	0% – 98%
Impact protection	IK08 (except lens)
Sustainability	PVC free
Country of origin	NDS-5703-F360/NDS-5704-F360: Thailand NDS-5703-F360-GOV/NDS-5704-F360-GOV: Taiwan

Ordering information

NDS-5703-F360 Fixed dome 6MP 360°

360° 6MP panoramic camera with HDR, IVA Pro Buildings, IVA Pro Perimeter, microphone array for Intelligent Audio Analytics, H.265

NDAA compliant

Order number **NDS-5703-F360**

NDS-5704-F360 Fixed dome 12MP 360°

360° 12MP panoramic camera with HDR, IVA Pro Buildings, IVA Pro Perimeter, microphone array for Intelligent Audio Analytics, H.265

NDAA compliant

Order number **NDS-5704-F360**

NDS-5703-F360-GOV Fixed dome 6MP 360° Gov

360° 6MP panoramic camera with HDR, IVA Pro Buildings, IVA Pro Perimeter, microphone array for Intelligent Audio Analytics, H.265
NDAA and TAA compliant

Available in North America only

Order number **NDS-5703-F360-GOV**

NDS-5704-F360-GOV Fixed dome 12MP 360° Gov

360° 12MP panoramic camera with HDR, IVA Pro Buildings, IVA Pro Perimeter, microphone array for Intelligent Audio Analytics, H.265
NDAA and TAA compliant

Available in North America only

Order number **NDS-5704-F360-GOV**

Accessories

NDA-5081-PIP Pendant interface plate, 110mm

Pendant interface plate for the FLEXIDOME micro 3100i indoor and the FLEXIDOME panoramic 5100i families

Order number **NDA-5081-PIP**

NDA-U-WMT Pendant wall mount

Universal wall mount for dome cameras, white

Order number **NDA-U-WMT**

NDA-U-WMP Wall mount plate

Back plate for universal wall mount, corner mount and pole mount, white, IP66

Order number **NDA-U-WMP**

NDA-U-PMT Pendant pipe mount, 12" (31cm)

Universal pipe mount for dome cameras, 31 cm, white

Order number **NDA-U-PMT**

NDA-U-PMTE Pendant pipe extension, 20" (50cm)

Extension for universal pipe mount, 50 cm, white

Order number **NDA-U-PMTE**

NDA-U-PMTS Pendant pipe mount, 4" (11 cm)

Universal pendant pipe mount for dome cameras, 11 cm (4"), white

Order number **NDA-U-PMTS**

NDA-U-PSMB Pendant wall/ceiling mount SMB

Surface mount box (SMB) for wall mount or pipe mount.

Order number **NDA-U-PSMB**

NDA-U-PMAS Pole mount adapter small

Pole mount adapter small

Universal pole mount adapter, white; small.

Order number **NDA-U-PMAS**

NDA-U-PMAL Pole mount adapter large

Universal pole mount adapter, white; large

Order number **NDA-U-PMAL**

NDA-5081-PC Paintable cover, F360, 4pcs

Paintable cover for FLEXIDOME panoramic 5100i

Order number **NDA-5081-PC**

NDA-5081-TM Tilt mount 20°, 110mm

Tilt mount (20°) for FLEXIDOME panoramic 5100i indoor and FLEXIDOME micro 3100i indoor

Order number **NDA-5081-TM**

NDA-5081-PLEN In-ceiling plenum rated kit, 110mm

Plenum-rated in-ceiling mount kit for FLEXIDOME panoramic 5100i and FLEXIDOME micro 3100i

Order number **NDA-5081-PLEN**

NDA-U-CMT Corner mount adapter

Universal corner mount, white

Order number **NDA-U-CMT****NDA-U-PMTG Pendant pipe mount, gang box**

Universal pipe mount, compatible with gang box installation for fixed dome cameras only, white

Order number **NDA-U-PMTG****NDA-U-WMTG Pendant wall mount, gang box**

Universal wall mount, compatible with gang box installation for fixed dome cameras only, white

Order number **NDA-U-WMTG****NDA-3081-4S 4S adapter plate, 171mm**

4S adapter plate for FLEXIDOME micro 3100i indoor

Order number **NDA-3081-4S****NPD-5001-POE Midspan, 15W, single port, AC in**

Power-over-Ethernet midspan injector for use with PoE enabled cameras; 15.4 W, 1-port

Weight: 200 g (0.44 lb)

Order number **NPD-5001-POE****NPD-5004-POE Midspan, 4 port x 15W, AC in**

Power-over-Ethernet midspan injector for use with PoE enabled cameras; 15.4 W, 4-ports

Weight: 620 g (1.4 lb)

Order number **NPD-5004-POE****MSD-064G IP SECURITY MICROSD CARD 64GB**

64 GB industrial microSD card with health status monitoring

Order number **MSD-064G****MSD-128G IP SECURITY MICROSD CARD 128GB**

128 GB industrial microSD card with health status monitoring

Order number **MSD-128G****MSD-256G IP SECURITY MICROSD CARD 256GB**

256 GB industrial microSD card with health status monitoring

Order number **MSD-256G****Software Options****MVC-IAA-TRIAL Trial License, 60-day**

Trial License, 60-day

Order number **MVC-IAA-TRIAL****MVC-IAA-GUN Gunshot Detector License, perpetual**

Gunshot Detector License, perpetual

Order number **MVC-IAA-GUN**