



BOSCH

BVMS

en

Operation manual

Table of contents

1	Using the Help	8
1.1	Finding information	8
1.2	Printing the Help	8
2	Introduction	10
3	System overview	12
3.1	Hardware requirements	13
3.2	Software requirements	13
3.3	License requirements	13
4	Concepts	14
4.1	BVMS design concepts	14
4.1.1	Single Management Server System	14
4.1.2	Enterprise System	15
4.1.3	Server Lookup	16
4.1.4	Unmanaged site	17
4.2	Automated Network Replenishment (ANR)	18
4.3	Alarm handling	20
4.4	Region of Interest (ROI)	21
4.5	Intelligent Tracking	22
4.6	Inactivity logoff	23
4.7	Malfunction relay	23
4.8	Text data	24
4.9	Offline Operator Client	24
4.9.1	Working with Offline Mode	25
4.10	Version independent Operator Client	27
4.10.1	Working with Compatibility Mode	27
4.11	Viewing modes of a panoramic camera	28
4.11.1	360° panoramic camera - floor- or ceiling mounted	28
4.11.2	180° panoramic camera - floor- or ceiling mounted	30
4.11.3	360° panoramic camera - wall mounted	31
4.11.4	180° panoramic camera - wall mounted	32
4.11.5	Cropped view on a panoramic camera	33
4.12	Verification of authenticity	34
4.13	SSH Tunneling	35
5	Getting started	36
5.1	Starting Operator Client	36
5.2	Accepting a new configuration	36
5.3	Accessing the system	37
5.4	Using Server Lookup	37
6	Displaying camera images	39
6.1	Selecting a time zone	39
6.2	Displaying a camera in an Image pane	40
6.3	Displaying a panoramic camera	40
6.4	Switching the viewing mode of panoramic camera	41
6.5	Displaying a dual thermal/optical camera	41
6.6	Displaying cameras from multiple Management Servers	42
6.7	Finding an item in the Logical Tree	42
6.8	Changing the number of Image pane rows	42
6.9	Arranging and resizing Image panes	43

6.10	Displaying the Alarm Image window	44
6.11	Starting manual recording	44
6.12	Starting a pre-configured camera sequence	45
6.13	Starting an automatic camera sequence	45
6.14	Using one channel audio mode	46
6.15	Using multichannel audio mode	46
6.16	Using digital zoom	47
6.17	Saving a single image	47
6.18	Printing a single image	48
6.19	Switching to full-screen mode	48
6.20	Displaying or hiding the Image pane bars	48
6.21	Displaying information on a camera	48
6.22	Enabling video content analysis (VCA)	49
6.23	Showing video content analysis (VCA) rules	49
6.24	Starting instant playback	49
6.25	Assigning a camera to a monitor	50
6.26	Using audio mode	50
6.27	Using the Intercom functionality	50
6.28	Locking the control of a PTZ camera	52
6.29	Updating the reference image	52
6.30	Displaying a monitor group	53
6.31	Controlling a monitor wall	53
6.32	Selecting live stream for display	53
6.33	Displaying video via low bandwidth	54
6.34	Using TCP for reliable connection	56
6.35	Connecting to an unmanaged site	56
6.36	Displaying a video analytics alarm	57
6.37	Displaying Intelligent Insights widgets	57
7	Using maps and the PTZ cameras	58
7.1	Displaying a map	58
7.2	Controlling PTZ cameras	58
7.3	Using in-window control of a camera	59
7.4	Using the ROI function	59
7.5	Using Intelligent Tracking	60
8	Using favorites and bookmarks	61
8.1	Adding items to the Favorites Tree	61
8.2	Creating/editing views	62
8.3	Adding a bookmark	63
8.4	Editing a bookmark	64
8.5	Loading a bookmark	64
8.6	Exporting bookmarks	64
9	Managing recorded videos	66
9.1	Selecting a time zone	66
9.2	Playing recorded videos	67
9.3	Using the Timeline	67
9.4	Changing the playback speed	68
9.5	Restricting video	68
9.6	Protecting video	69
9.7	Deleting video data	69

9.8	Verifying the authenticity of video data	70
9.9	Exporting video data	70
9.9.1	Exporting bookmarks	71
9.9.2	Exporting a time period	71
9.9.3	Exporting a single search entry	72
9.10	Providing a password for export	72
9.11	Exporting into a single file	73
9.12	Loading exported video	73
9.13	Performing a Forensic Search (only VRM recordings)	74
9.14	Enabling video content analysis (VCA)	75
9.15	Finding motion	75
9.16	Finding logbook entries	76
9.16.1	Finding logons to an unmanaged site	76
9.16.2	Finding Person Identification events and alarms	76
9.17	Finding recorded video	77
9.18	Displaying text data	78
9.19	Erasing text data from Person Identification logbook entries	79
9.20	Displaying video via low bandwidth	79
9.21	Switching the recording source	81
9.22	Connecting to an unmanaged site	81
10	Handling events and alarms	83
10.1	Accepting an alarm	83
10.2	Adding comments to an alarm	84
10.3	Clearing an alarm	84
10.4	Customizing the Alarm List window	85
10.5	Displaying the Live Image window	85
10.6	Switching alarm modes of Alarm Image window	85
10.7	Starting a workflow	86
10.8	Un-accepting an alarm	86
10.9	Triggering a user event	87
11	Managing Person Identification alarms	88
11.1	Managing persons for a Person Identification alarm	88
12	Controlling intrusion panel functions	90
12.1	Switching off alarm sirens	90
12.2	Operating doors	90
12.3	Bypassing a point	90
12.3.1	Arming an area	91
13	Controlling access control functions	92
13.1	Granting and denying access	92
14	Using a CCTV keyboard	93
14.1	Using KBD Universal XF keyboard	93
14.1.1	KBD Universal XF keyboard user interface	93
14.2	Bosch IntuiKey keyboard user interface	95
14.2.1	Status display	96
14.3	Using a Bosch IntuiKey keyboard connected to a workstation	96
14.3.1	Starting the keyboard	97
14.3.2	Entering operation modes	97
14.3.3	Displaying cameras	97
14.3.4	Using the joystick	98

14.3.5	Using softkeys	98
14.4	Using a Bosch IntuiKey keyboard connected to a decoder	100
14.4.1	Starting the keyboard	100
14.4.2	Displaying cameras	101
14.4.3	Using the joystick	101
14.4.4	Using softkeys	101
15	User interface	102
15.1	Live Mode	102
15.2	Playback Mode	104
15.3	Alarm Mode (Alarm Display)	106
15.4	Icons used	109
15.5	Menu commands	112
15.6	Reference Image dialog box	115
15.7	Please select a Server	116
15.8	Select Search Parameters dialog box	116
15.9	Search for Text Data dialog box	119
15.10	Search Conditions dialog box	119
15.11	Device Selection dialog box	119
15.12	Event Selection dialog box	120
15.13	Logbook Results: dialog box	120
15.14	Options dialog box	120
15.14.1	Control tab	120
15.14.2	Display tab	121
15.14.3	Audio tab	121
15.14.4	Transcoding tab	122
15.15	Logical Tree window	122
15.16	Favorites Tree window	123
15.17	Bookmarks window	123
15.18	Add Bookmark dialog box	124
15.19	Search box	124
15.20	Exports window	125
15.21	Map window	125
15.22	Monitor Wall Image window	125
15.23	PTZ Control window	126
15.24	Image window	126
15.25	Image pane	127
15.26	Timeline window	128
15.27	Motion Search dialog box	130
15.28	Delete Video dialog box	131
15.29	Forensic Search dialog box	131
15.30	Restrict Video dialog box	132
15.31	Unrestrict Video dialog box	133
15.32	Protect Video dialog box	133
15.33	Unprotect Video dialog box	134
15.34	Delete Video dialog box	134
15.35	Export Video dialog box	135
15.36	Export Bookmark dialog box	137
15.37	Export Multiple Bookmarks dialog box	139
15.38	Export dialog box	141

15.39	Authenticity Verification Result dialog box	141
15.40	Motion Search Results window	142
15.41	Video Search Results window	143
15.42	Alarm List window	143
16	Keyboard shortcuts	144
16.1	General controls	144
16.2	Playback controls	144
16.3	Image window controls	144
17	Troubleshooting	145
17.1	Updating an old BVMS Archive Player version	145
17.2	Reestablishing the connection to a Bosch IntuiKey keyboard	146
	Glossary	147
	Index	152

1 Using the Help

To find out more about how to do something in BVMS, access the online Help using any of the following methods.

To use the Contents, Index, or Search:

- ▶ On the **Help** menu, click **Display Help**. Use the buttons and links to navigate.

To get help on a window or dialog:

- ▶ On the toolbar, click  .

OR

- ▶ Press F1 for help on any program window or dialog.

1.1 Finding information

You can find information in the Help in several ways.

To find information in the Online Help:

1. On the **Help** menu, click **Help**.
2. If the left-hand pane is not visible, click the **Show** button.
3. In the Help window, do the following:

Click:	To:
Contents	Display the table of contents for the Online Help. Click each book to display pages that link to topics, and click each page to display the corresponding topic in the right-hand pane.
Index	Search for specific words or phrases or select from a list of index keywords. Double-click the keyword to display the corresponding topic in the right-hand pane.
Search	Locate words or phrases within the content of your topics. Type the word or phrase in the text field, press ENTER, and select the topic you want from the list of topics.

Texts of the user interface are marked **bold**.

- ▶ The arrow invites you to click on the underlined text or to click an item in the application.

Related Topics

- ▶ Click to display a topic with information on the application window you currently use.

This topic provides information on the application window controls.

Concepts, page 14 provides background information on selected issues.



Notice!

This symbol indicates a potential risk of property damage or data loss.

1.2 Printing the Help

While using the Online Help, you can print topics and information right from the browser window.

To print a Help topic:

1. Right-click in the right pane and select **Print**.
The **Print** dialog box opens.
2. Click **Print**.





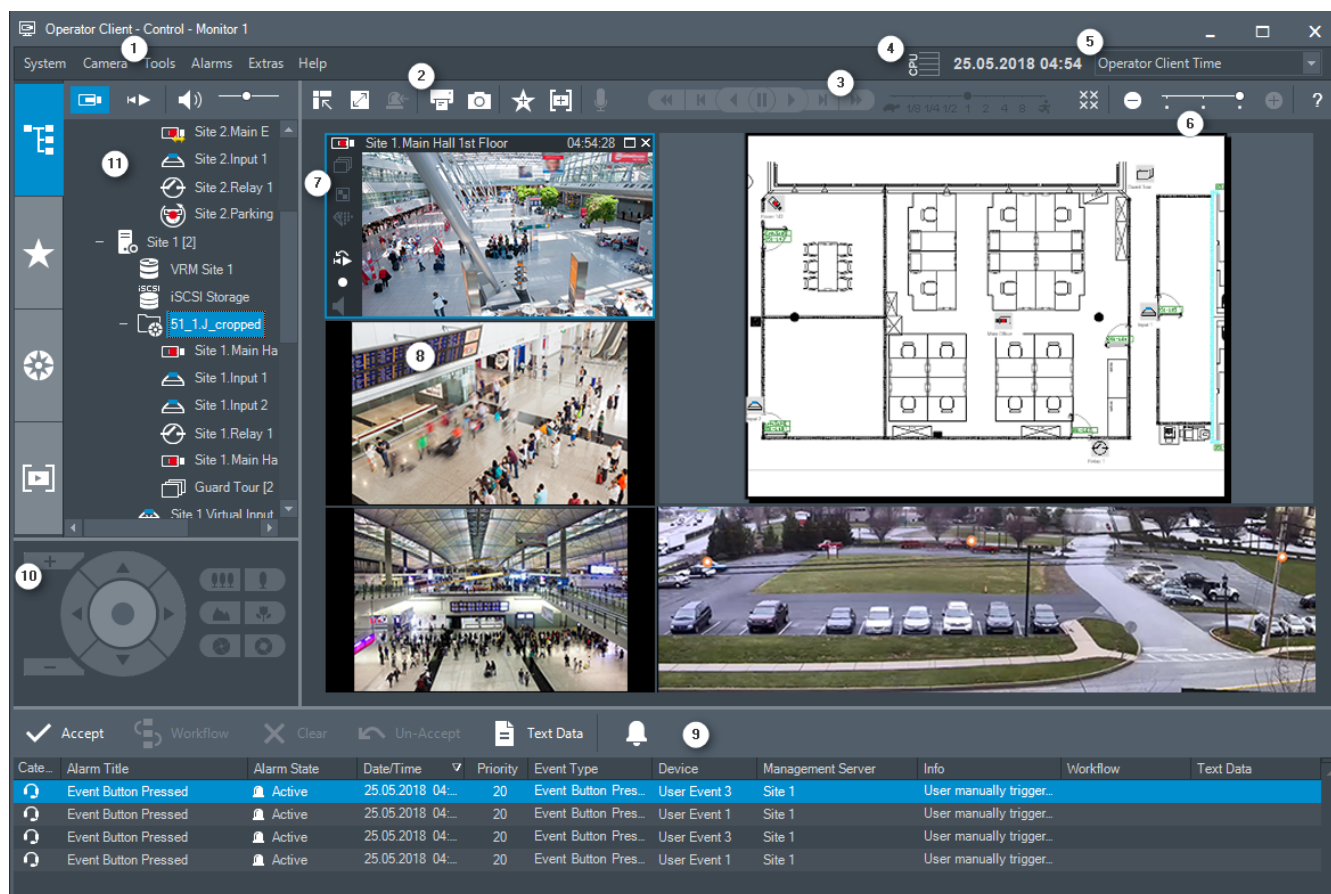

- ✓ The topic is printed to the specified printer.

2 Introduction

Click the link to access the Open Source Software licenses used by BVMS and the Mobile App:
<http://www.boschsecurity.com/oss/>



1	Menu bar	Allows you to select a menu command.
2	Toolbar	Displays the available buttons. Point to an icon to display a tooltip.
3	Playback controls	Allows you to control instant playback or a camera sequence or alarm sequence.
4	Performance meter	Displays the CPU usage and the memory usage.
5	Time zone selector	Select an entry for the time zone to be displayed in most time related fields. Only available if at least one Management Server or unmanaged site in the Logical Tree is located in another time zone as your Operator Client.
6	Controls for Image panes	Allows you to select the required number of Image panes and to close all Image panes.
7	Image window	Displays the Image panes. Allows you to arrange the Image panes.
8	Image pane	Displays a camera, a map, an image, a document (HTML file).

9	 <p>Alarm List window</p>	<p>Displays all alarms that the system generates. Allows you to accept or clear an alarm or to start a workflow, for example, by sending an E-mail to a maintenance person.</p> <p>The Alarm List is not being displayed, when the connection to the Management Server is lost.</p>
10	 <p>PTZ Control window</p>	<p>Allows you to control a PTZ camera.</p>
11	 <p>Logical Tree window</p>	<p>Displays the devices your user group has access to. Allows you to select a device for assigning it to an Image pane.</p>
	 <p>Favorites Tree window</p>	<p>Allows you to organize the devices of the Logical Tree as required.</p>
	 <p>Bookmarks window</p>	<p>Allows to manage bookmarks.</p>
	 <p>Map window</p>	<p>Displays a site map. Allows you to drag the map to display a particular section of the map.</p> <p>If activated, a map is displayed automatically for each camera displayed in an Image pane. In this case, the camera must be configured on a map.</p>

This manual guides you through the basic steps of the configuration and operation with BVMS. For detailed help and step-by-step instructions read the Configuration Manual and the User Manual or use the Online Help.

BVMS Archive Player displays exported recordings.

3 System overview

If you plan to install and configure BVMS, participate in a system training on BVMS. Refer to the Release Notes of the current BVMS version for supported versions of firmware and hardware and other important information.

See data sheets on Bosch workstations and servers for information on computers where BVMS can be installed.

The BVMS software modules can optionally be installed on one PC.

Important components

Component	Description
Management Server (selectable in Setup)	Stream management, alarm management, priority management, Management logbook, user management, device state management. Additional Enterprise System license: Managing Enterprise User Groups and Enterprise Accounts.
Config Wizard	Easy and fast setup of a recording system.
Configuration Client (selectable in Setup)	System configuration and administration for Operator Client.
Operator Client (selectable in Setup)	Live monitoring, storage retrieval and playback, alarm and accessing multiple Management Server computers simultaneously.
Video Recording Manager (selectable in Setup)	Distributing storage capacities on iSCSI devices to the encoders, while handling load balancing between multiple iSCSI devices. Streaming playback video and audio data from iSCSI to Operator Clients.
Mobile Video Service (selectable in Setup)	Provides a transcoding service that transcodes the live and recorded video stream from a camera configured in BVMS to the available network bandwidth. This service enables video clients like an iPhone or a Web client to receive transcoded streams, for example for unreliable network connections with limited bandwidth.
Web Client	You can access live and playback videos via Web browser.
Mobile App	You can use the Mobile App on iPhone or iPad to access live and playback video.
Bosch Video Streaming Gateway (selectable in Setup)	Provides the integration of 3rd party cameras and NVR-like recording, e.g. in low-bandwidth networks.
Cameo SDK (selectable in Setup)	The Cameo SDK is used to embed BVMS live and playback Image panes to your external third-party application. The Image panes follow the BVMS based user permissions. The Cameo SDK provides a subset of the BVMS Operator Client functionalities that enables you to create applications similar to the Operator Client.

Component	Description
Client Enterprise SDK	The Client Enterprise SDK is meant to control and monitor the behaviour of Operator Client of an Enterprise System by external applications. The SDK allows to browse devices that are accessible by the running, connected Operator Client and to control some UI functionalities.
Client SDK / Server SDK	The Server SDK is used to control and monitor the Management Server by scripts and external applications. You can use those interfaces with a valid administrator account. The Client SDK is used to control and monitor the Operator Client by external applications and scripts (part of the related server configuration).

3.1 Hardware requirements

See the data sheet for BVMS. Data sheets for platform PCs are also available.

3.2 Software requirements

See the data sheet for BVMS.

BVMS must not be installed on a computer where you want to install BVMS Archive Player.

3.3 License requirements

See the data sheet for BVMS for the available licenses.

4 Concepts

This chapter provides background information on selected issues.

4.1 BVMS design concepts

Single Management Server System, page 14

A single BVMS Management Server System provides management, monitoring and control of up to 2000 cameras/encoders.

Enterprise System, page 15

An Enterprise Management Server provides simultaneous access to multiple Management Servers. The Enterprise System allows full access to events and alarms from multiple subsystems.

Server Lookup, page 16

The Server Lookup feature provides a list of available BVMS Management Servers to the BVMS Operator Client. The Operator can select a server out of the list of available server. Connected to the Management Server the Client has full access to the Management Server.

Unmanaged site, page 17

Devices can be grouped to unmanaged sites. Devices under unmanaged sites are not monitored by the Management Server. The Management Server provides a list of unmanaged sites to the Operator Client. The Operator can connect on demand to the site and gets access to live video data and recorded video data. Event and alarm handling is not available in the unmanaged site concept.





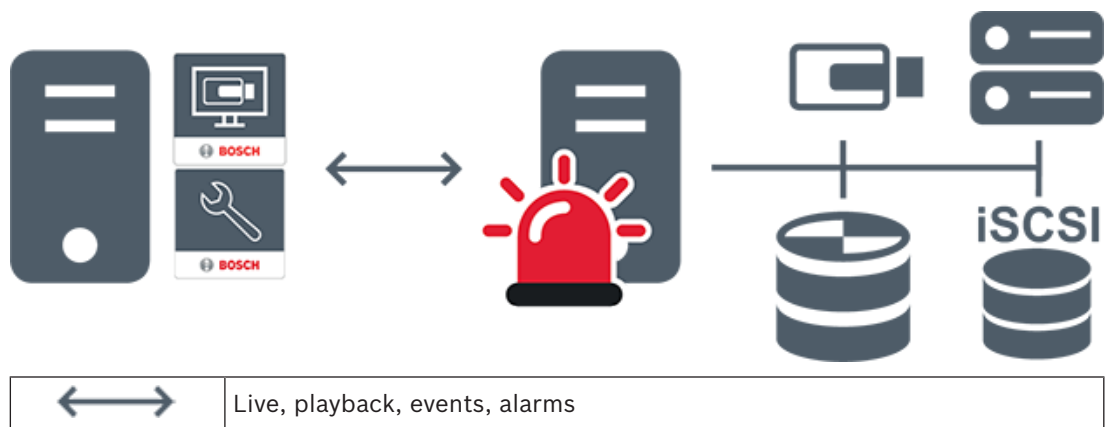

4.1.1 Single Management Server System

- A single BVMS Management Server can manage up to 2000 channels.
- A BVMS Management Server provides management, monitoring, and control of the entire system.
- The BVMS Operator Client is connected to the Management Server and receives events and alarms from the BVMS Management Server and shows live and playback.
- In most cases all devices are in one local area network with a high bandwidth and a low latency.

Responsibilities:

- Configuring data
- Event log (logbook)
- User profiles
- User priorities
- Licensing
- Event- and alarm-management







	Management Server
	Operator Client / Configuration Client
	Cameras
	VRM
	iSCSI
	Other devices

4.1.2

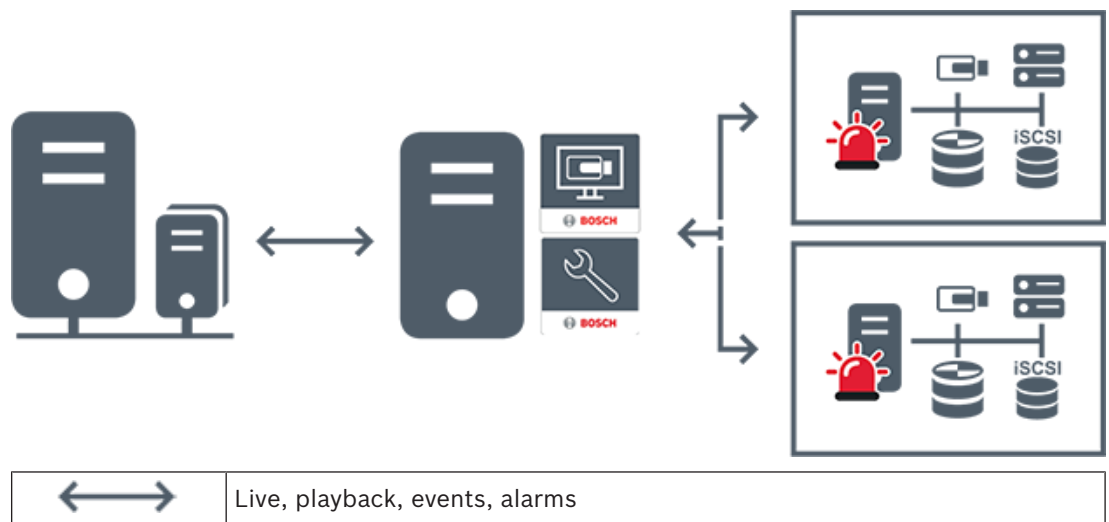
Enterprise System

- The target of a BVMS Enterprise System is to enable a user of an Operator Client to simultaneously access multiple Management Servers (subsystems).
- Clients connected to an Enterprise Server have full access to all cameras and recordings from the subsystems.
- Clients connected to an Enterprise Server have full real time awareness of events and alarms of all subsystems.
- Typical application areas:
 - Metros
 - Airports



	BVMS Enterprise Management Server
	BVMS Operator Client / Configuration Client
	BVMS Subsystem

See also



- *Accessing the system, page 37*



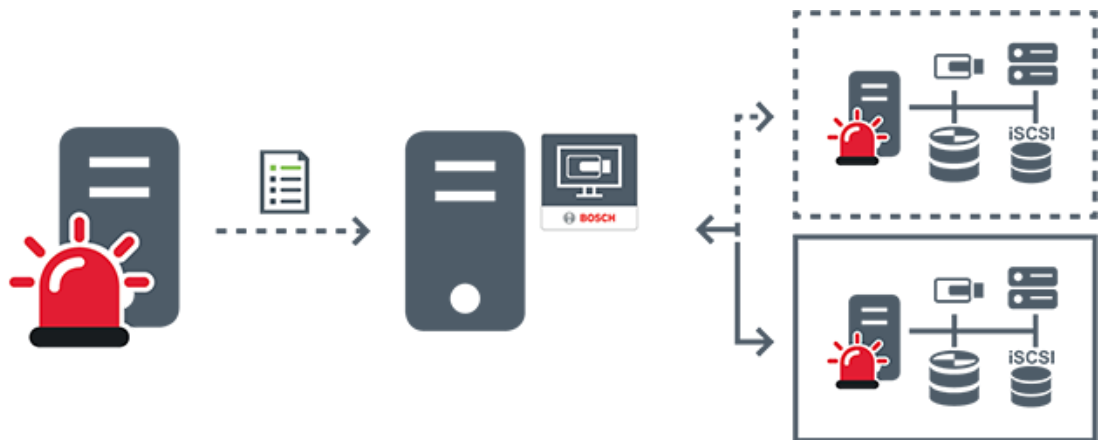

4.1.3

Server Lookup

- The BVMS Server Lookup feature allows Operators to connect to a BVMS Management Server out of a provided list of servers.
- A single user of Configuration Client or Operator Client can connect to multiple system access points sequentially.
- System access points can be Management Server or Enterprise Management Server.
- Server Lookup uses dedicated Management Server to host the Server List.
- Server Lookup and Management Server or Enterprise Management Server functionally can be run on one machine.
- Server Lookup supports you in locating system access points by their names or descriptions.
- Once connected to the Management Server the Operator Client receives events and alarms from the BVMS Management Server and shows live and playback



	On demand live, playback, events, alarms - connected
	On demand live, playback, events, alarms - not connected
	Management Server

	Server list
	Operator Client
	Connected BVMS from server list
	Not connected BVMS from server list

See also

- *Using Server Lookup, page 37*

4.1.4**Unmanaged site**

- A system design option in BVMS with a large number of small subsystems.
- It allows to configure up to 9999 locations in one BVMS Management Server
- Operators can access live and recorded video data from up to 20 sites simultaneously.
- For an easy navigation sites can be grouped in folders or can be placed on maps. Predefined username and password allow operators to quickly connect to a site .

The unmanaged site concept supports IP based BVMS system as well as analog DVR solutions:

- Bosch DIVAR AN 3000 / 5000 analog recorders
- DIVAR hybrid recorders
- DIVAR network recorders
- DIP 3000/7000 units IP based recording
- Single BVMS Management Server System

Adding a site for central monitoring only requires a license per site and is independent of the number of channels in the site.

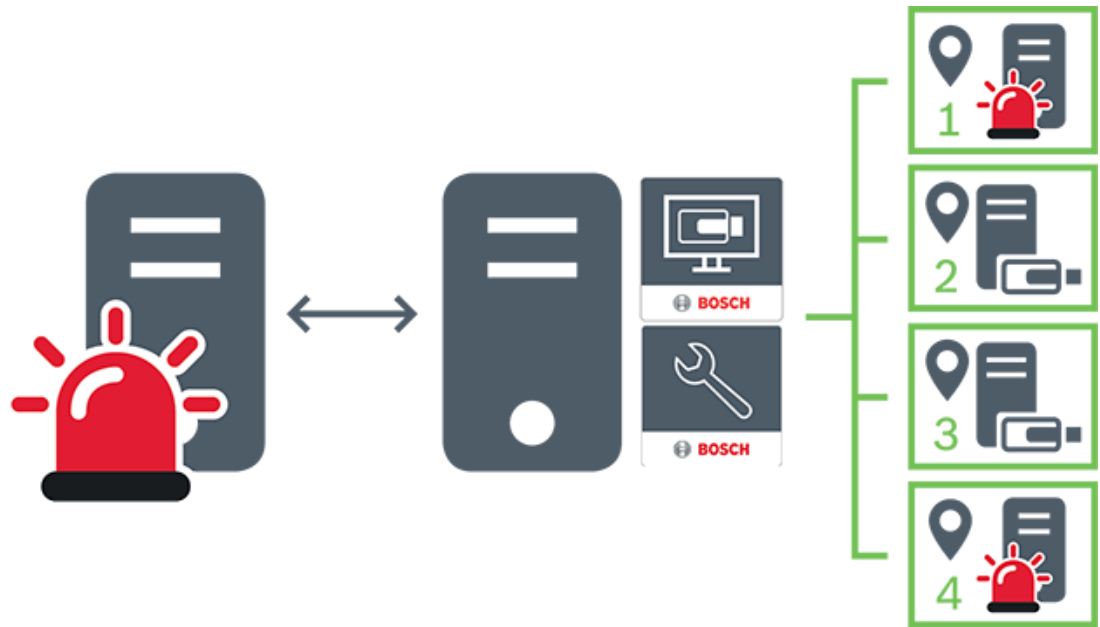

	Live, playback, events, alarms
	On demand live and playback video traffic
	Management Server
	Operator Client / Configuration Client
	site
	DVR

4.2 Automated Network Replenishment (ANR)

Intended use

When a failure of the network or the central storage occurs, the ANR function ensures that the encoder transmits the locally buffered recording of the missing time period to the central storage after the failure is fixed.

The following graphic shows the transmission of video data after a network or storage failure is fixed.

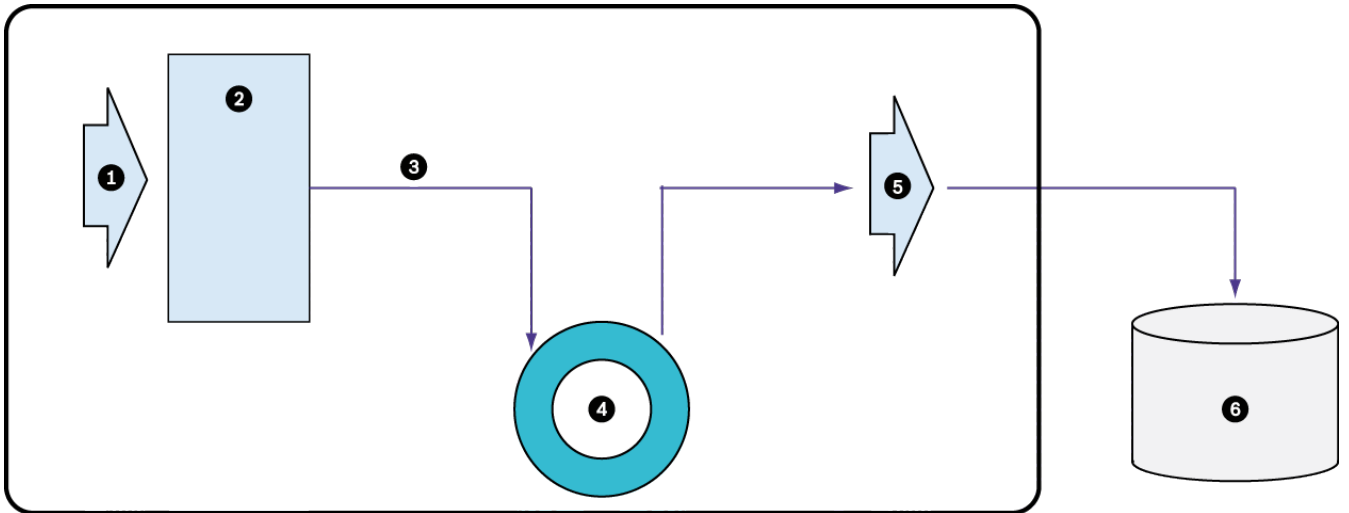

1	Video	5	IP network
2	Encoder	6	iSCSI target (central storage)
3	Write to buffer immediately		
4	SD card (ring buffer)		

Example: Work around network failure

If the network fails unexpectedly, the ANR function completes the central storage with the locally buffered recording when the network is available again.

Example: Store video data when network is not available

A subway has no network connection to the central storage when located between stations. Only during regular stops the buffered recording can be transmitted to the central storage. Ensure that the time period that is required for transferring the buffered recording, does not exceed the time period of a stop.

Example: ANR for alarm recording

The pre-alarm recording is stored locally. Only in case of an alarm, this pre-alarm recording is transmitted to the central storage. If no alarm occurs, the obsolete pre-alarm recording is not transmitted to the central storage and, hence, does not burden the network.

Limitations



Notice!

You cannot use playback from the local storage media when the passwords for `user` and `live` are set on the encoder. Remove the passwords if required.

The ANR function only works with VRM recording.

The ANR function does not work with an encoder for which a secure connection for live display is configured.

You must have configured the storage media of an encoder to use the ANR function.

The encoder for which you configure the ANR function, must have firmware version 5.90 or later. Not all encoder types support the ANR function.

You cannot use the ANR function with dual recording.

Your iSCSI storage system must be properly configured.

The following list contains the possible reasons if you cannot configure the ANR function:

- Encoder is not reachable (wrong IP address, network failure, etc.).
- Storage media of the encoder not available or read-only.
- Wrong firmware version.
- Encoder type does not support the ANR function.
- Dual recording is active.

4.3 Alarm handling

Alarms can be individually configured to be handled by one or more user groups. When an alarm occurs, it appears in the Alarm List of all users in the user groups configured to receive that alarm. When any one of these users starts to work on the alarm, it disappears from the Alarm List of all other users.

Alarms are displayed on a workstation's alarm monitor. This behavior is described in the following paragraphs.

Alarm flow

1. An alarm occurs in the system.
2. Alarm notifications appear in the Alarm Lists of all users configured for this alarm. Alarm video is immediately displayed on configured monitors. If it is an automatically displayed alarm (auto pop-up), the alarm video is also automatically displayed on the Operator Client workstation's alarm monitors.
If the alarm is configured as an auto-clear alarm, the alarm is removed from the Alarm List after the auto-clear time (configured in the Configuration Client).
On monitors, any quad views from VIP XDs are temporarily replaced by full-screen displays.
3. One of the users accepts the alarm. The alarm video is then displayed on this user's workstation (if it is not already displayed via auto pop-up). The alarm is removed from all other Alarm Lists and alarm video displays.
4. The user who accepted the alarm invokes a workflow that can include reading an action plan and entering comments. This step is optional - requirements for workflow can be configured by the administrator.
5. Finally, the user clears the alarm. This removes the alarm from his Alarm List and alarm display.
On a monitor group, the monitors return to the cameras that were displayed before the alarm occurred.

Alarm Image window

1. To display alarm video, the Alarm Image window replaces the Live or Playback Image window on the monitor that has been configured for alarm display.
2. Each alarm gets a row of Image panes. Up to 5 Image panes can be associated with each alarm. These Image panes can display live video, playback video, or maps.
On a monitor group, each alarm can call up cameras on a row of monitors. The number of cameras in the row is limited by the number of columns in the monitor group. Monitors in the row that are not used for alarm video can be configured to either continue with their current display or to display a blank screen.
3. Higher priority alarms are displayed above lower priority alarms on both monitor rows and the Operator Client workstation display alarm rows.
4. If the Alarm image window is completely full of Alarm image rows and an additional alarm must be displayed, the lowest priority alarms "stack up" in the bottom row of the Alarm image window. You can step through the stacked alarms with the controls at the left side of the alarm row.

You can step through the alarm stacks on monitor groups with control buttons in the **Monitors** window of the Operator Client workstation display. Monitors in alarm are indicated by red icons with blinking "LEDs".

The alarm title, time, and date can be optionally be displayed on all monitors, or only the first monitor in the alarm row.

5. For equal priority alarms, the administrator can configure the order behavior:
 - Last-in-First-out (LIFO) mode: in this configuration, new alarms are inserted *above* older alarms of the same priority.
 - First-in-First-out (FIFO) mode; in this configuration, new alarms are inserted *below* older alarms of the same priority.
6. An alarm's Image row can appear in the Alarm Image window in one of two ways:
 - When it is generated (auto pop-up). This occurs when the alarm priority is higher than display priority.
 - When the alarm is accepted. This occurs when the alarm priority is lower than display priority.

Auto pop-up alarms

Alarms can be configured to automatically display (pop up) in the Alarm Image window, based on the alarm priority. Each user group's live and playback displays are also assigned priorities. When alarms are received with priority higher than that of the user's display, the alarm automatically displays its alarm row in the Alarm Image window. If the Alarm Image window is not currently displayed, it automatically replaces the Live or Playback Image window on the alarm-enabled monitor.

Although auto pop-up alarms are displayed in the Alarm Image window, they are not automatically accepted. They can be displayed on multiple users' displays simultaneously. When a user accepts an auto pop-up alarm, it is removed from all other users Alarm Lists and alarm displays.

Alarm handling in case of shutdown

On a server shutdown all active alarms are preserved. The alarms are restored and reappear in the **Alarm List** window, when the system restarts.

Alarms in the state **Accepted** or **Workflow** are automatically set back to the state **Active** when the system restarts. Comments entered for alarms in the state **Workflow** are preserved.



Notice!

The alarm data is automatically saved every minute, so the maximum data loss is the data accumulated in one minute.

See also

- *Alarm Mode (Alarm Display)*, page 106
- *Handling events and alarms*, page 83

4.4 Region of Interest (ROI)

Intended use

Intended use of ROI is to save network bandwidth when zooming into a section of the camera image with a fixed HD camera. This section behaves like a PTZ camera.

Functional description

The ROI feature is only available for stream 2.

Fixed HD cameras provide ROI streams with SD resolution.

When a TCP connection is used in Live Mode, the encoder adapts the encoding quality to the network bandwidth. The best adapted quality never exceeds the configured quality of the stream.

In addition to that the encoder streams only the area selected by the user (through zooming and panning actions).

The usage of ROI has the following advantages:

- Decreased network bandwidth usage
- Decreased decoding performance required on the client

A user with a higher priority for PTZ control can take over the control of ROI and can change the image section. The recording of stream 2 has the highest priority. This means that a continuous recording of stream 2 makes the control of ROI impossible. If alarm recording of stream 2 is configured, you cannot control ROI when an event occurs that triggers alarm recording.

Limitations

You can use ROI only with fixed HD cameras.

You can use ROI only in Live Mode.

Enable TCP mode for this camera to adapt the network bandwidth. The encoder adapts the encoding quality to the network bandwidth. Whenever a second client is requesting the same stream (for example for recording), the bandwidth adaptation is turned off.

Additionally the required performance of the decoding process on the client is decreased.

If stream 2 is configured to **H.264 MP SD ROI** or **H.265 MP SD ROI** on the **Cameras and Recording** page but not yet set on the encoder, the PTZ control does not work. Activate the configuration to set this property on the encoder.

See also

- *Using the ROI function, page 59*

4.5

Intelligent Tracking

Intended use

Intended use of Intelligent Tracking is to enable a camera to follow a selected object. You can configure whether the selection of an object is automatically or manually. The camera can be a PTZ camera or a fixed HD camera (only with ROI enabled).

The following 3 modes are available:

- **Off:** Intelligent Tracking is turned off.
- **Auto:** Intelligent Tracking turned on, the largest object is automatically selected for tracking, recommended use: rarely moving objects in the image.
- **Click:** User selects object to be tracked.

After selecting the object to be tracked, a PTZ camera moves to follow the object until this object leaves the visible area of the camera or the operator stops tracking.

A fixed HD camera with the Intelligent Tracking feature enabled defines a surrounding region close to the borders of the selected object and zooms into the image to display only the region. Then the region is moved according to the movement of the object.

Limitations

Intelligent Tracking can only be used for Live operations. You cannot use Intelligent Tracking later in recorded videos.

For a PTZ camera to be used for Intelligent Tracking, we recommend configuring to return to a defined preposition after a longer period of inactivity. Otherwise it can happen that a PTZ camera follows an automatically selected object and after the object having disappeared, the PTZ camera shows an irrelevant image.

See also

- *Using Intelligent Tracking, page 60*

4.6 Inactivity logoff

Intended use

Intended use of inactivity logoff is to protect an Operator Client or Configuration Client during the absence of the operator or administrator.

You can configure per user group that Operator Client shall be logged off automatically after a specified time period without activity.

For Configuration Client no user groups are available. The inactivity logoff setting is valid only for the **admin** user.

All operations with keyboard, mouse and CCTV keyboard affect the specified time period for inactivity logoff. Automatic activities of Operator Client do not affect the time period.

Automatic activities of Configuration Client like firmware upload or iSCSI setup prevent the inactivity logoff.

You can also configure the inactivity logoff for a BVMS Web Client.

Short before an inactivity logoff, a dialog box reminds the user to actively prevent the inactivity logoff.

The Logbook records an occurred inactivity logoff.

Example

If a workstation is located in a public area, the inactivity logoff minimizes the risk that on an unattended workstation Operator Client is accessed by an unauthorized person.

An administrator group member shall logoff automatically after inactivity but a desk officer (operator group) might just watch video without operating the system and does not want an inactivity logoff.

Limitations

Client SDK activity does not support the inactivity logoff, this means that the activity of Client SDK does not affect the specified time period.

4.7 Malfunction relay

Intended use

A malfunction relay is intended to switch in case of any severe system error to trigger an external alert (strobe, siren, etc.).

The user must reset the relay manually.

The malfunction relay can be one from the following list:

- BVIP encoder or decoder relay
- ADAM relay
- Intrusion panel output

Example

If something happens that severely affects the system functioning (for example a hard disk failure) or an incident occurs that endangers the security of a site (for example a failing reference image check), the malfunction relay is activated. This can for example trigger an audible alarm or can close doors automatically.

Functional description

You can configure a single relay to act as a malfunction relay. The malfunction relay gets activated automatically when an event from a set of user-defined events is triggered.

Activation of a relay means that a command will be sent to the relay to close it. The

subsequent “Relay Closed” event is decoupled from the command and will only be generated and received if the relay state is physically changed! For example a relay being closed before, will not send this event.

Apart from being automatically triggered by the set of user-defined events, the malfunction relay is treated like any other relay. Therefore, the user is able to deactivate the malfunction relay in Operator Client. The Web Client also allows deactivating the malfunction relay. Because the regular access permissions apply to the malfunction relay as well, all clients need to consider the permissions of the logged-on user.

4.8 Text data

Intended use

The operator can search for text data to find the corresponding recordings. The text data must be stored in the Logbook.

Text data is delivered by systems like foyer card readers, automatic teller machines or virtual inputs. Text data contains textual transaction data like account numbers and bank routing codes.

Functional description

Text data of a device is recorded together with the corresponding video data.

Limitations

For searching recordings with text data, the text data must be configured to be stored in the Logbook.

The encoder for which you configure the recording text data function, must have firmware version 5.92 or later.

The text data of maximum 32 different devices can be recorded synchronously for one camera. Maximum 3000 bytes of text data can be stored on an encoder per event.

If you see problems with Logbook searches, display of additional data, or CSV exports of Logbook search results, the reason can be that the additional text data contains non-printable characters, for example x00-x1F.

See also

- *Search for Text Data dialog box, page 119*
- *Displaying text data, page 78*

4.9 Offline Operator Client

With the feature of the Offline Operator Client the following use cases are possible:

- Operator Client continues operation for Live, Playback and Export without connection to the Management Server computer.
- If a workstation was connected once to the Management Server computer, it can log on offline any time with any user.

For Offline Mode BVMS must have version 3.0 or later.

If an Operator Client workstation is disconnected from the Management Server computer, it is possible to continue working. Some main functions are still available, for example live and playback video.

As of BVMS V5.5 an Operator Client workstation can work offline with a configuration of BVMS V5.0.5.

**Notice!**

When a password change on the Management Server occurs during the period when Operator Client is offline, this password change is not propagated to this Operator Client. When Operator Client is online, the user must log on using the new password. When Operator Client is offline, the user must again use the old password for logon. This is not changed until a new configuration is activated and transferred to the Operator Client workstation.

**Notice!**

When a camera is called up for display in a monitor group with a workstation connected Bosch Intuikey keyboard, and the workstation is offline, the keyboard does not send an error tone.

4.9.1

Working with Offline Mode

When Operator Client is disconnected from a Management Server, a respective overlay icon is displayed in the Logical Tree on the disconnected Management Server. You can continue working with Operator Client even if the disconnection lasts longer, but some functions are not available.

If the connection to the Management Server is reestablished, a respective overlay icon is displayed.

If a new configuration on a Management Server has been activated, a respective icon is displayed in the Logical Tree on the icon of the affected Management Server and a dialog box is displayed for some seconds. Accept or refuse the new configuration.

If your Operator Client instance is scheduled to log off at a specific point in time, this logoff occurs even when the connection to the Management Server is not reestablished at this point in time.

When a user of Operator Client logs on using Server Lookup in offline state, the Server List of the last successful logon is displayed. Offline state here means that the Operator Client workstation does not have a network connection to the server containing the Server List.

Functions not available during disconnection

When disconnected from Management Server the following functions are not available in Operator Client:



- Alarm List:
This includes handling alarms. The alarm list is empty and will automatically be filled on reconnection.
- Allegiant:
The trunk line handling is not available. In earlier versions, Allegiant cameras were automatically closed with a message-box when a trunk line handling was unavailable. With BVMS V3.0 we will show a more user friendly Image pane informing the user about the impossibility to display this camera right now.
- MG:
It is not possible to drag cameras on the MG control. The control is disabled and will automatically be enabled on reconnection.
- PTZ priorities:
Without a connection to Management Server, an offline Operator Client can connect a PTZ camera as long as the PTZ camera itself is not locked. The dome priorities will automatically be updated on reconnection.
- Input:
Input cannot be switched.

- Logbook:
The Logbook is not available and cannot be opened. An opened Logbook search window is not closed automatically. Existing search results can be used and exported.
- Operator Client SDK:
Operator Client SDK functions with IServerApi cannot be processed.
Creating a RemoteClientApi is not possible.
Some methods that are only available at client API do not work, for example ApplicationManager (try GetUserName()).
- Password change:
The operator is not able to change his password.
- Relay:
Relays cannot be switched.
- Server Script:
The server methods of the IServerApi will be processed but cannot be sent to the Client which are:
 - AlarmManager
 - AnalogMonitorManager
 - CameraManager
 - CompoundEventManager
 - DecoderManager
 - DeviceManager
 - DomeCameraManager
 - EventManager
 - InputManager
 - LicenseManager
 - Logbook
 - MatrixManager
 - RecorderManager
 - RelayManager
 - ScheduleManager
 - SendManager
 - SequenceManager
 - VirtualInputManager
- State overlays:
No state overlays of cameras, inputs or relays are available.

States of Operator Client

A BVMS Operator Client gives you a visual and textual feedback of its states.

Following Operator Client states are possible:

-  The Operator Client is connected to the Management Server.
-  The Operator Client is not connected to the Management Server. One reason can be a physical disconnection from the Management Server to the network.
- 

This state can only be displayed after a reestablished connection to the Management Server. All affected functions are back, but the configuration of the Operator Client is outdated due to a newer configuration available in the system. Log on again to update the configuration.



This state icon is displayed when the Management Server has an earlier BVMS version than the Operator Client workstation.

Device state overlay

The device states (recording dot, too noisy, too dark, ...) are processed by the Management Server. On disconnection between Client and Server the states cannot be updated in the Client. A new state overlay will give you a visual feedback that all device states are not available at the moment. If the client has an established connection to the server again, the state overlays are updated automatically.

-  State unknown

The state overlay of a device in the Logical Tree or on a map when client is disconnected from the Management Server computer.

Reasons for disconnection

Reasons for disconnection between Operator Client and Management Server can be:

- Physical connection is broken.
- Password of logged on user has changed during offline time.
- Management Server has given away floating workstation license to another online Operator Client while the now disconnected Operator Client was offline.
- Operator Client and Management Server have different versions (Management Server earlier than version 5.5).

4.10

Version independent Operator Client

For Compatibility Mode both Operator Client and Management Server must have a version later than 5.5.

A user of Operator Client can successfully log on to a Management Server where a previous software version is running.

If the server provides a newer configuration than available on the Operator Client workstation, this configuration is automatically copied to the Operator Client workstation. The user can decide to download the new configuration.

Operator Client provides a reduced feature set and is connected to this Management Server. The following Management Server related features are available after logon to a Management Server with a previous version:

- User preferences
- Start manual recording
- Display of device states
- Toggling relay states
- Searching the Logbook
Search for events is not possible.
- Server Lookup
- Remote export

4.10.1

Working with Compatibility Mode

This feature is available in versions later than 5.5.

A BVMS Operator Client gives you a visual and textual feedback of its states.

Following Operator Client states are possible:



The Operator Client is connected to the Management Server.



The Operator Client is not connected to the Management Server. One reason can be a physical disconnection from the Management Server to the network.



This state can only be displayed after a reestablished connection to the Management Server. All affected functions are back, but the configuration of the Operator Client is outdated due to a newer configuration available in the system. Log on again to update the configuration.



This state icon is displayed when the Management Server has an earlier BVMS version than the Operator Client workstation.

4.11 Viewing modes of a panoramic camera

This chapter illustrates the viewing modes of a panoramic camera which are available in BVMS.

The following viewing modes are available:

- Circle view
- Panorama view
- Cropped view

Panorama and cropped view modes are created by the dewarping process in BVMS. Edge dewarping is not used.

The administrator must configure the mounting position of a panoramic camera in Configuration Client.

You can resize the Image pane of a camera as required. The Image pane ratio is not restricted to the 4:3 or 16:9 aspect ratio.

See also

- *Displaying a panoramic camera, page 40*
- *Switching the viewing mode of panoramic camera, page 41*
- *Arranging and resizing Image panes, page 43*

4.11.1 360° panoramic camera - floor- or ceiling mounted

The following figure illustrates the dewarping of a 360° camera which is floor- or ceiling mounted.

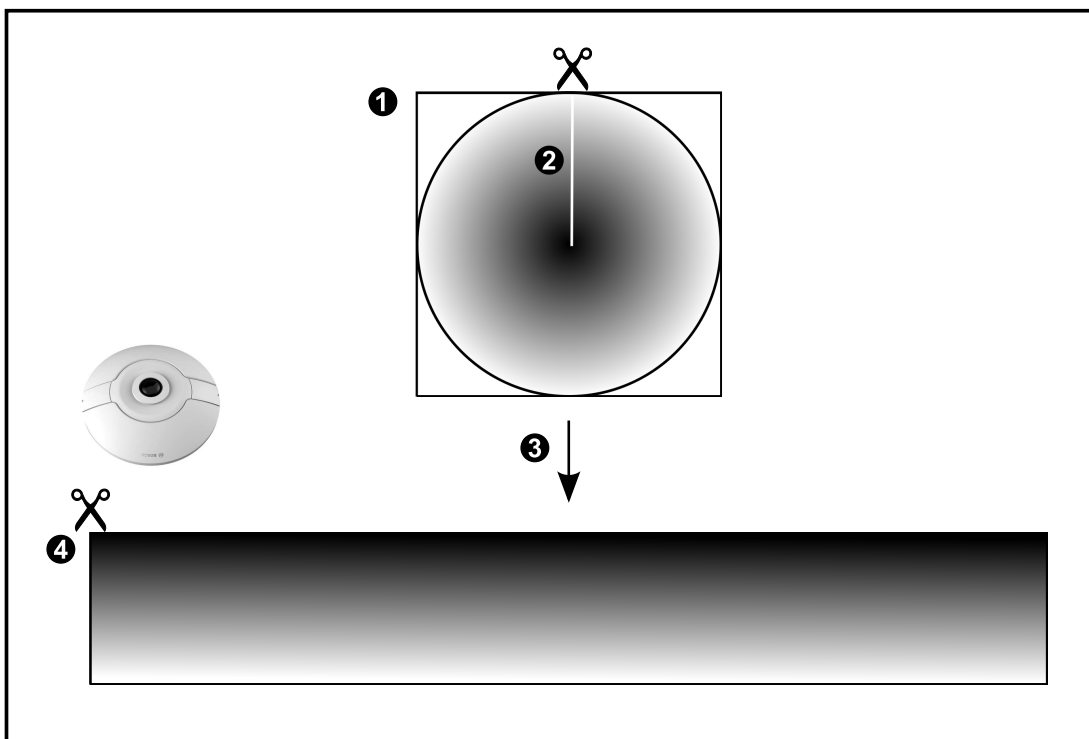
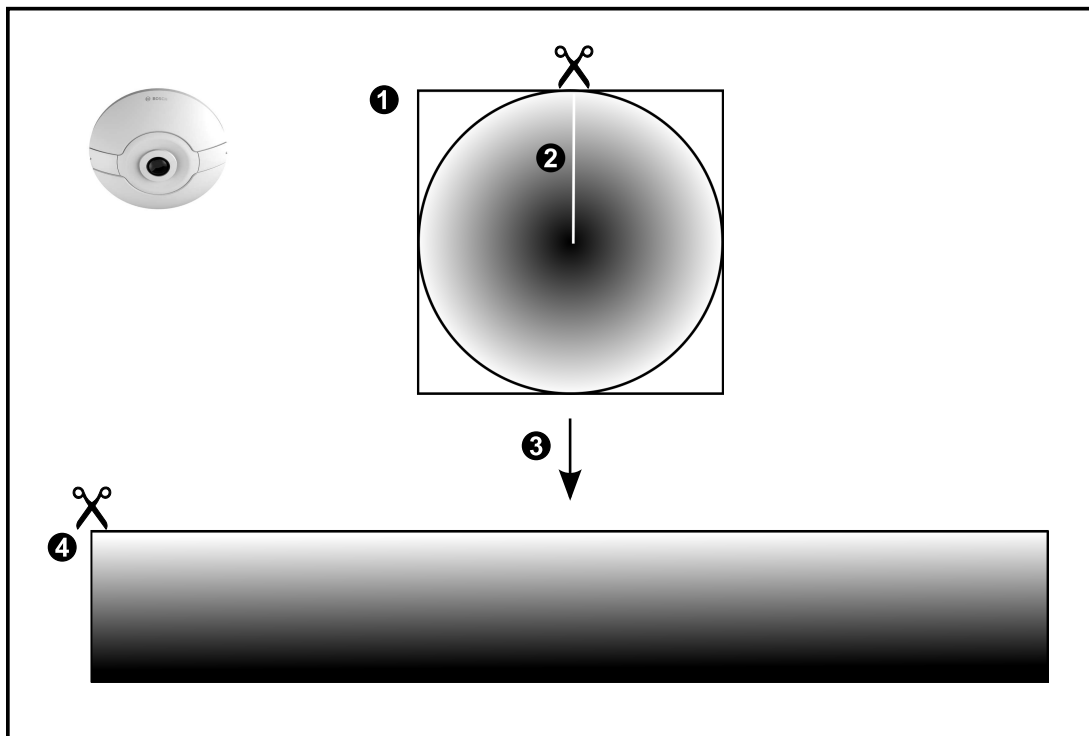

1	Full circle image	3	Dewarping
2	Snipping line (operator can change its position when not zoomed in)	4	Panorama view

4.11.2

180° panoramic camera - floor- or ceiling mounted

The following figure illustrates the dewarping of a 180° camera which is floor- or ceiling mounted.

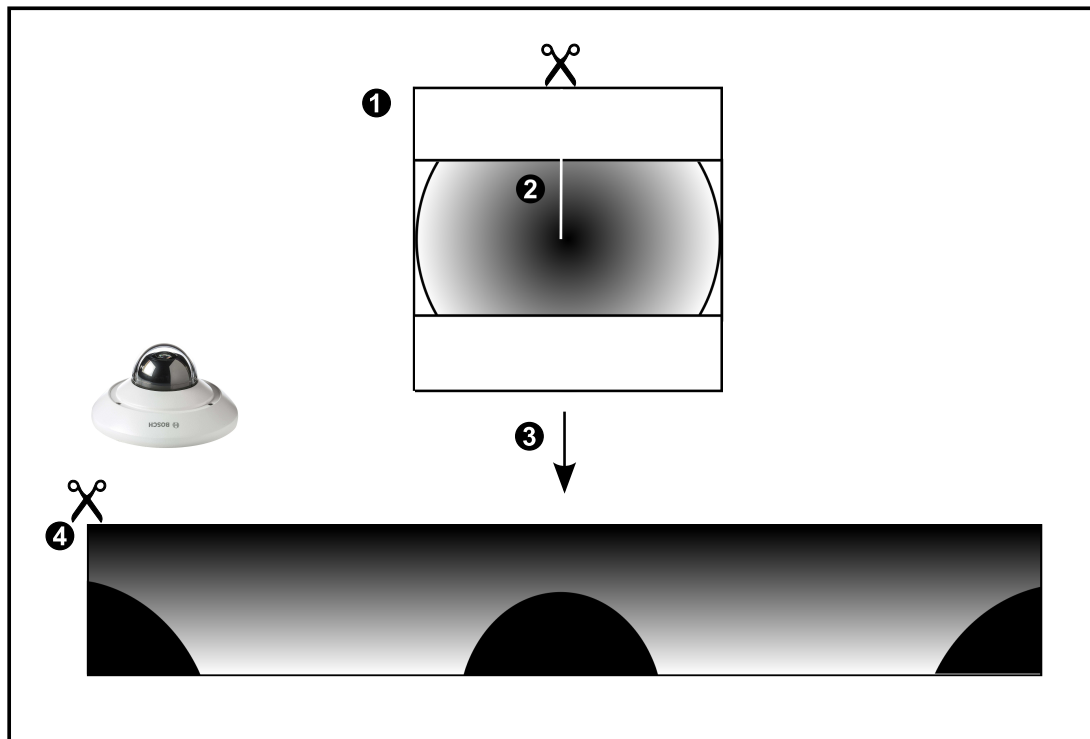
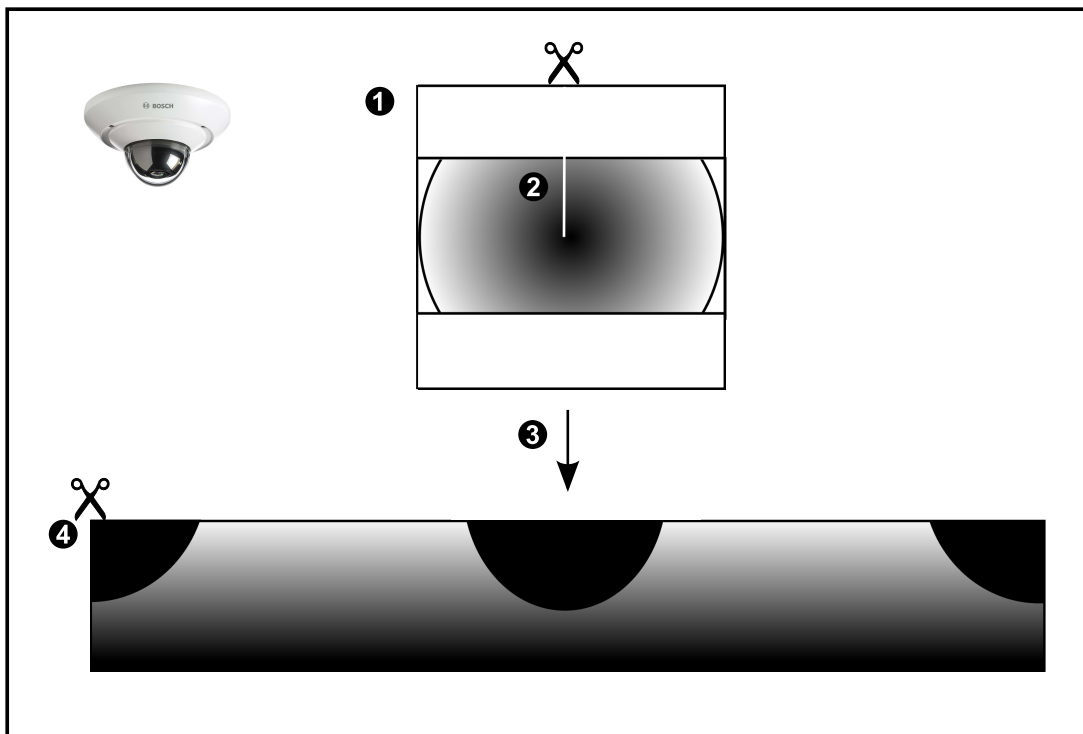

1	Full circle image	3	Dewarping
2	Snipping line (operator can change its position when not zoomed in)	4	Panorama view

4.11.3

360° panoramic camera - wall mounted

The following figure illustrates the dewarping of a 360° camera which is wall mounted.

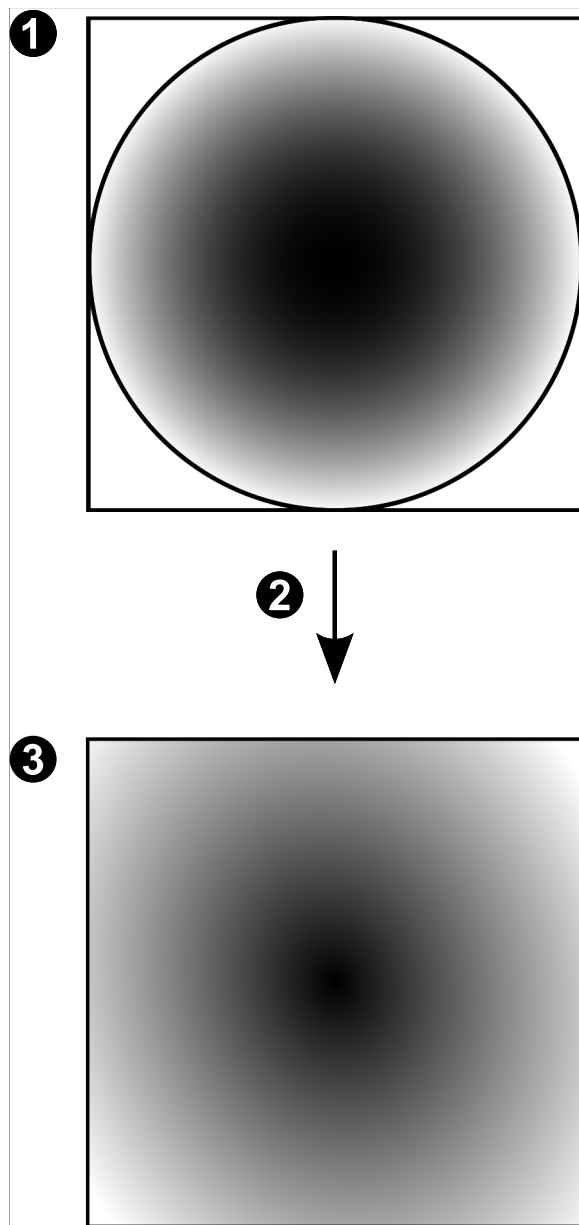

1	Full circle image	3	Panorama view
2	Dewarping		

4.11.4 180° panoramic camera - wall mounted

The following figure illustrates the dewarping of a 180° camera which is wall mounted.

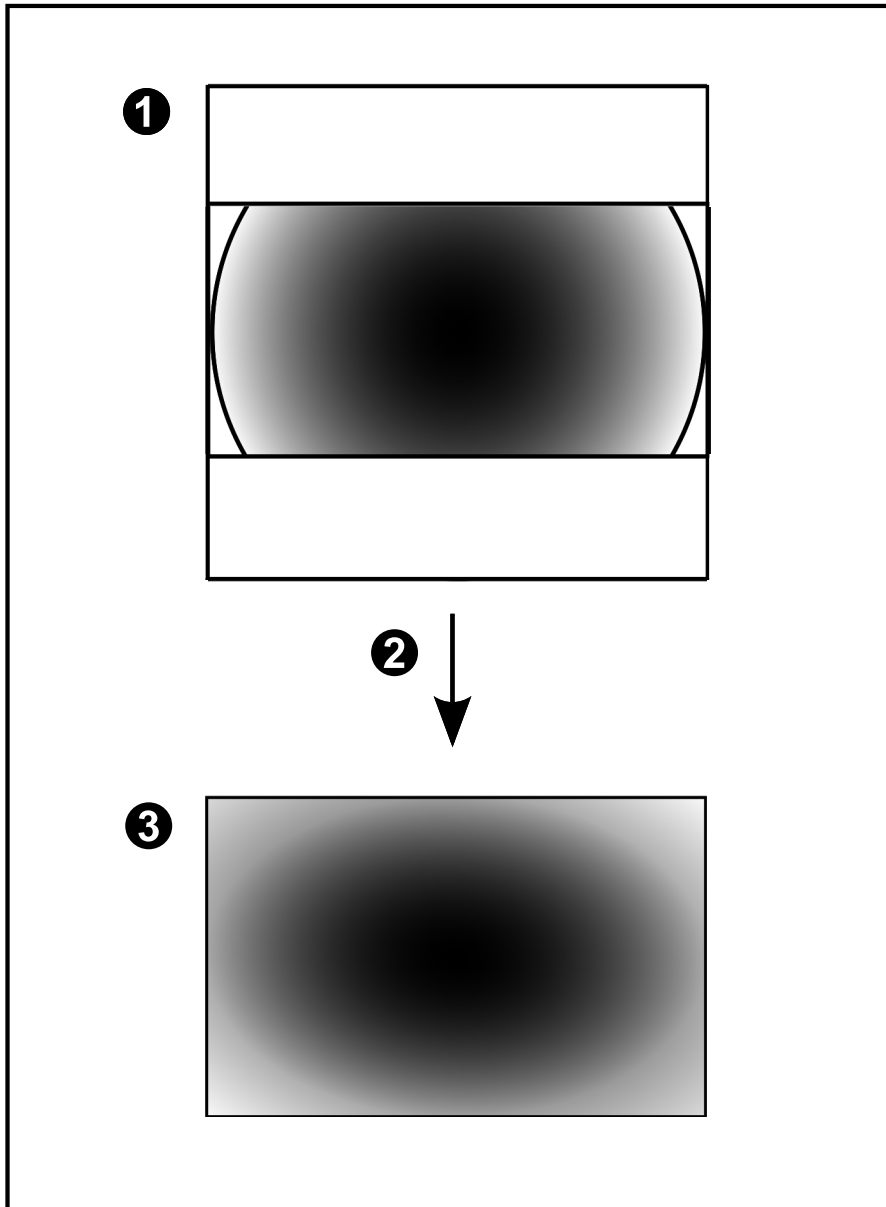

1	Full circle image	3	Panorama view
2	Dewarping		

4.11.5 Cropped view on a panoramic camera

The following example figure illustrates the cropping of a 360° camera which is floor- or ceiling mounted.

The rectilinear section used for cropping is fixed. You can change the section in the cropped Image pane using the available PTZ controls.

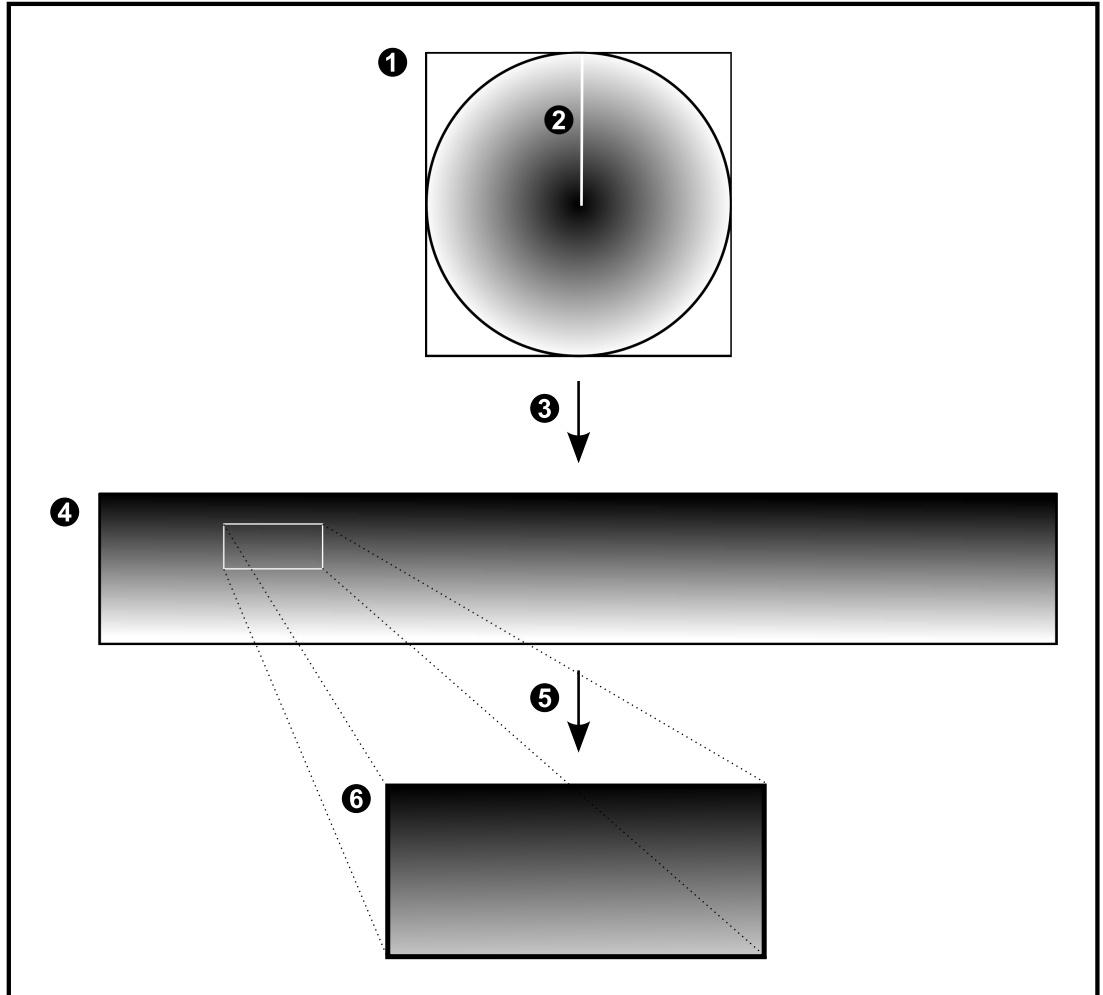

1	Full circle image	4	Panorama view
2	Snipping line (operator can change its position when not zoomed in)	5	Cropping
3	Dewarping	6	Cropped Image pane

4.12 Verification of authenticity

The user of Operator Client can verify the authenticity of recordings. The authenticity of exports is automatically verified.

The administrator must follow these steps for ensuring an unbroken certificate chain. For large systems (>30 cameras) we recommend the following procedure:

- Let your issuing certificate authority (CA) issue a certificate for each encoder.
- Upload the issued certificate (including private key) in a secure way on each encoder.
- Install the CA certificate on the Operator Client workstations where you want to perform authenticity verification or on other computers where you want to perform exports.

For small systems (<30 cameras) we recommend the following procedure:

- Download the `HTTPS Server` certificate from each encoder.
- Install these certificates on the Operator Client workstations where you want to perform authenticity verification.

Ask the IT support of your company for details.

For activating the secure verification of authenticity, the administrator must perform the following steps:

- Activate the authentication on each desired camera.
- For large systems: Upload and assign the appropriate certificate to each desired camera.
- For small systems: Download a certificate from each encoder. Install the certificates allowing verification on a workstation.

Limitations

Firmware version 6.30 or later is required.

We recommend verifying the authenticity of maximum 4 cameras at the same time.

The user of Operator Client cannot verify the authenticity of live video.

Note: Do not change the certificate when recording is running. If you have to change the certificate, first stop the recording, change the certificate, and start recording again.

For verifying the authenticity of a recording, this recording is replayed in a background process with maximum speed. In networks with low bandwidth the playback can be slow. The verify process can then take as long as the time period selected for verifying. Example: You select a time period of 1 hour. The verifying process can last up to 1 hour.

The user can only verify that a recording is authentic. If the verification process is not successful, this does not necessarily mean that the video has been manipulated. Many other reasons can be responsible for the failure, for example a manual deletion. The user of Operator Client cannot distinct between an intended change of the recording or fraudulent manipulation.

Video authentication deals solely with methods of validating the authenticity of video. Video authentication does not deal with the transmission of video, or data, in any way.

The watermark feature for verifying authenticity in earlier BVMS versions is replaced. The new authenticity verification is automatically available after upgrade to the latest BVMS version.

Authenticity checks that were successful in the past, can now not be verified because these recordings do not contain the required extended information.

Verifying authenticity is not supported in the following cases:

- Transcoding
- Local recording
- VSG
- Digital Video Recorder
- Bosch Recording Station
- ANR

See also

- *Verifying the authenticity of video data, page 70*
- *Exporting video data, page 70*

4.13**SSH Tunneling**

BVMS provides remote connectivity utilizing Secure Shell (SSH) tunneling. SSH tunneling constructs an encrypted tunnel established by an SSH protocol/socket connection. This encrypted tunnel can provide transport to both encrypted and un-encrypted traffic. The Bosch SSH implementation also utilizes Omni-Path protocol, which is a high performance low latency communications protocol developed by Intel.

Technical aspects and restrictions

- SSH tunneling utilizes port 5322. This port cannot be modified.
- The SSH Service must be installed on the same server as the BVMS Management Server.
- User accounts must have a configured password. User accounts without a password cannot log on utilizing a SSH connection.
- Configuration Client cannot connect remotely via SSH. Configuration Client connection must be done via port mapping.
- Operator Client checks connection with SSH service every 15 seconds. If the connection is interrupted, Operator Client retests the connection every minute.

Port mapping

- ▶ Configure one port forwarding for the BVMS Management Server to utilize port 5322 for both internal and external connections.
This is the only port mapping entry that you need to make for the entire system.
BVMS port mapping is not required.

Encrypted communication

After the connection is established via a SSH tunnel, all communications between the BVMS Management Server and a remote client are encrypted.

5 Getting started

This chapter provides information on how to get started with BVMS.

5.1 Starting Operator Client

Note:

- Before using the system, activate the licenses that you have ordered. The Configuration Manual or the Configuration Client Online Help describe how to activate the licenses.
- To be sure that your BVMS uses the language that you need, please configure this language in your Configuration Client. See the Online Help for details.

If a newer version of BVMS is running on the Management Server, this version is installed automatically by no-touch deployment when you log on.

To start Operator Client:

1. From the **Start** menu, select **Programs** > BVMS > Operator Client.
The dialog box for logging on is displayed.
2. In the **User Name:** field, type your user name.
When you start the application for the first time, type Admin as user name, no password required.
To access multiple Management Server computers simultaneously, type the user name of a member of an Enterprise User Group.
3. In the **Password:** field, type your password.
4. In the **Connection:** list, select the IP address or the DNS name of the Management Server or Enterprise Management Server.

Note: If you use a SSH connection, select **<New...>** and enter the address in the following format: **ssh://IP or servername:5322**.

To use a SSH connection user accounts must have a configured password (see *SSH Tunneling, page 35*).

5. Click **Ok**.
If dual authorization has been configured for your user group, the next logon dialog is displayed.
A user of the configured second user group enters the required information.
The application starts.
If dual authorization is optional, just click **Ok** again on the second logon dialog box. But you then only have the user rights of your user group and not the potentially extended user rights of your dual authorization group.

To quit Operator Client:

1. On the **System** menu, click **Exit**.
The application quits.
If you logged on to Operator Client as a user who is not authorized to quit the application, the **Enter Logoff Password** dialog box is displayed.
2. Ask a user with corresponding user rights to enter his user name and password to confirm the process.

5.2 Accepting a new configuration

When the system administrator activates a new configuration from within Configuration Client, each Operator Client is either immediately restarted automatically or the user of a workstation is informed about the new configuration and can accept it later. The system administrator configures which of these 2 cases occurs.

If the system administrator activated a new configuration without forcing each Operator Client workstation to accept the new configuration, a dialog box is displayed on all Operator Client workstations. The users can refuse or accept the new configuration. The dialog box is closed after a few seconds without user interaction. In this case the new configuration is refused. If a device (for example a camera) is removed from the system in the new configuration, some functions of this device are not available if you have refused the new configuration. If you change the password for a user or delete a user while this user is logged on, this user can still continue working with Operator Client after password change or deletion. If after password change or deletion the connection to Management Server is interrupted (for example after activating the configuration), the user cannot automatically reconnect to the Management Server again without logoff/logon at Operator Client.

To accept a new configuration:

- ▶ Log off and then log on again.
The new configuration is used now.

5.3 Accessing the system

You access a system performing the following steps:

1. Perform one of the following steps to select the network address of the desired system:
 - Click a preselected list entry.
 - Enter a network address manually.
 - Select a network address using Server Lookup.
2. Log on to the desired system:
 - Single server system
 - Enterprise System

5.4 Using Server Lookup

- The BVMS Server Lookup feature allows Operators to connect to a BVMS Management Server out of a provided list of servers.
- A single user of Configuration Client or Operator Client can connect to multiple system access points sequentially.
- System access points can be Management Server or Enterprise Management Server.
- Server Lookup uses dedicated Management Server to host the Server List.
- Server Lookup and Management Server or Enterprise Management Server functionally can be run on one machine.
- Server Lookup supports you in locating system access points by their names or descriptions.
- Once connected to the Management Server the Operator Client receives events and alarms from the BVMS Management Server and shows live and playback

To access:

1. Start Operator Client or Configuration Client.
The logon dialog box is displayed.
2. In the **Connection:** list, select **<Address Book...>** for Configuration Client or **<Address Book...>** for Operator Client.
If private and public IP address has been configured for a server, this is indicated.
If you select **<Address Book...>** or **<Address Book...>** for the first time, the **Server Lookup** dialog box is displayed.
3. In the **(Enterprise) Management Server Address:** field, type in a valid network address of the desired server.

4. Enter a valid user name and password.
5. If required, click **Remember Settings**.
6. Click **OK**.
The **Server Lookup** dialog box is displayed.
7. Select the desired server.
8. Click **OK**.
9. If the selected server has both a private and a public network address, a message box is displayed asking whether you are using a computer located in the private network of the selected server.
The server name is added to the **Connection:** list in the logon dialog box.
10. Select this server in the **Connection:** list and click **OK**.
If you have selected the **Remember Settings** check box, you can select this server directly when you again want to access this server.

6 Displaying camera images

This chapter provides information on how to display camera images. Some of the features described in this chapter can be deactivated for your user group.

6.1 Selecting a time zone

Main window



Notice!

Ensure that the time on all computers of your system is set correctly according to each time zone where the computers are located.

Management Server or unmanaged site and all connected devices including encoders, decoders, VRM Server computers, DiBos and DVR devices must be in the same time zone. Operator Client computers (including Client SDK and Cameo SDK) and Configuration Client computers can be in other time zones than the Management Server or unmanaged site. If your Operator Client is located in another time zone than one or more connected Management Server or unmanaged site, you can select one of the following time displays:

- Your local time
- UTC
- Time zone of the Management Server or unmanaged site you are connected to

The Image panes displaying a camera (live and playback) always show the time of the corresponding Management Server or unmanaged site.

In the Logical Tree,  is displayed on the device icon of each server or unmanaged site that do not share the time zone that is currently selected in the Operator Client:

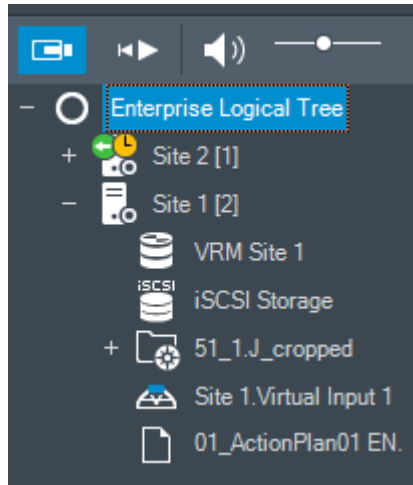

You can select the time zone of a server or unmanaged site for displaying this time zone in Operator Client.

To select the time zone:

1. In the Logical Tree, right-click a server icon to select the time zone of this server.
2. In the time zone selector list, select the desired entry.
 - **Operator Client Time:** Operator Client
 - **UTC**

- **UTC-x:** time zone of each available Management Server

The time based on the selected time zone is displayed in the menu bar:

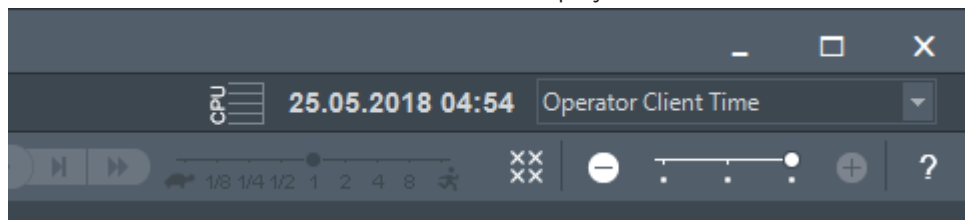

See also

- *Logical Tree window, page 122*

6.2 Displaying a camera in an Image pane

Main window

To assign a camera image to an Image pane:

- ▶ Drag a camera from the **Logical Tree** window to an Image pane.
The selected camera image is displayed in the Image pane.

Or:

1. Select an Image pane.
2. In the **Logical Tree** window, double-click a camera.
The selected camera image is displayed in the Image pane.
3. Repeat the above steps for every camera you want to display.
You can also drag maps and documents to Image panes.

Or:

- ▶ In the Logical Tree, right-click a camera and click **in next free Image pane**.
The camera is displayed.

To move a camera within the Image window:

- ▶ Drag the camera into another Image pane.

To zoom digitally:

- ▶ Rotate the wheel button forward or backward to zoom in or zoom out.

See also

- *Logical Tree window, page 122*
- *Image window, page 126*
- *Image pane, page 127*

6.3 Displaying a panoramic camera

Main window

You can display panoramic cameras. The original full image circle of a panoramic camera is automatically dewarped when displayed in an Image pane.

You can display panoramic cameras and use ePTZ in Live Mode and Playback Mode

You can select a point of interest of the panorama image for display in another Image pane.

This Image pane displays the cropped image. Cropping and using ePTZ in a cropped image is possible in Live and Playback Mode.

The Image window allows a flexible resizing of the Image pane that displays a panoramic camera or any other camera.

To display a panoramic camera:

1. Drag a camera with the  icon to an Image pane.
The camera image is displayed in panorama view.
2. Use the available control elements in the Image pane for navigating in the image.

To display a cropped image:

1. Display a panoramic camera in panorama view.
2. Press and hold the CTRL-key.
The mouse pointer changes accordingly.
3. Click and hold a point of interest.
4. Drag the selected point to another Image pane and drop it. Release the CTRL-key.
A section of the panorama view around the selected point is displayed.
You can create another cropped image from this cropped image with the same procedure.
We recommend displaying maximum 10 cropped Image panes simultaneously.
5. Use the available control elements in the Image pane for navigating in the image.

See also

- *Switching the viewing mode of panoramic camera, page 41*
- *Arranging and resizing Image panes, page 43*
- *Viewing modes of a panoramic camera, page 28*

6.4 Switching the viewing mode of panoramic camera



Main window

or

Main window >  > Select an Image pane with panoramic camera > 

You can switch the viewing mode for a panoramic camera displayed in an Image pane.

The following modes are available:

-  **Circle view**
-  **Panorama view** (initial view)
-  **Cropped view**

A panoramic camera must be configured in the Logical Tree for this user.

To switch:

- ▶ In the title bar of an Image pane displaying a panoramic camera, click the **Switch panoramic mode** icon and select the desired entry.

When the Image pane for this camera is closed and opened again, the **Panorama view** mode is displayed.

See also

- *Displaying a panoramic camera, page 40*
- *Viewing modes of a panoramic camera, page 28*
- *Image pane, page 127*

6.5 Displaying a dual thermal/optical camera

In Operator Client you can display the thermal and optical mode of a dual camera either separately or simultaneously.

To display the desired viewing mode of the camera:

- ▶ Drag the camera to an Image pane
or
Select an Image pane and in the **Logical Tree** window, double-click the desired camera.
The selected camera image is displayed in the Image pane.
The viewing mode is displayed in the title bar of the Image pane:

-  **Optical**
-  **Thermal**

To switch the viewing mode of the camera:

- ▶ In the title bar of the Image pane displaying the camera, select the desired viewing mode.

To display the thermal and optical mode of the camera simultaneously:

1. Select the Image pane displaying the camera.
2. Press the CTRL-key and drag and drop the camera image to another Image pane.
The second viewing mode of the camera is displayed in the new Image pane.

6.6 Displaying cameras from multiple Management Servers

Main window > **Enterprise Logical Tree**

Log on as a user of an Enterprise User Group.

In the Enterprise Logical Tree, expand the item of the desired Management Server. You can use the devices that are configured for this Management Server.

6.7 Finding an item in the Logical Tree



Main window

To find an item in the Logical Tree:

1. Right-click the root node or a child node of the Logical Tree and click **Tree search**
Or:

In the Logical Tree window press Ctrl + F.

The search box is displayed 

2. Type a search string representing the display name of an item.
The search is triggered immediately during typing and the first item that matches the search string is marked. If you want to display it in an Image pane, double-click it.
If the search string is not found, the background color of the search box changes.
3. Click  or  to mark the previous or the next matching item.
4. Click  to close the search box.

See also

- *Search box, page 124*

6.8 Changing the number of Image pane rows

Main window

You can change the number of Image pane rows displayed in the Image window.

To show fewer image pane rows:

- ▶ On the **Tools** menu, click **Show fewer Image pane rows**
or

Move the **Change image pane rows** slider  to the left
or

Click 
 or
 Press F7.

To show more Image pane rows:

- ▶ On the **Tools** menu, click **Show more Image pane rows**
 or

Move the **Change image pane rows** slider  to the right
 or

Click 
 or
 Press F8.



Notice!

The maximum number of Image pane rows displayed in the Image window is configured in the BVMS Configuration Client.

If you have reached this number, the **Show more Image pane rows** menu command and the

 button are disabled.

If the maximum number of Image pane rows has been set to 1, the **Change image pane rows** slider  is not displayed.



Notice!

This limitation does not affect the BVMS Archive Player.

6.9 Arranging and resizing Image panes

Main window

To arrange Image panes:

1. Drag an item from the **Logical Tree** window to an Image pane. Repeat this until all required cameras are displayed.

If an object is already displayed in a target Image pane, this object is replaced.

2. Drag a camera from one Image pane to another, if required.

To resize an Image pane:

1. Point to a border or corner of an Image pane. The pointer appears as a double-headed arrow.

You can resize diagonally, vertically or horizontally.

The resulting size of the Image pane is limited to the grid of the select Image pane pattern.

The Image pane ratio is not restricted to the 4:3 or 16:9 aspect ratio.

2. Drag to resize the Image pane.

See also

- *Image window, page 126*

6.10 Displaying the Alarm Image window

Main window

You can switch from the Image window to the Alarm Image window if at least one alarm is in the Alarm List.



Notice!

A map displayed in an Alarm Image pane is optimized for display and contains only the initial view of the basic .dwf file.

To display the Alarm Image window:

- ▶ In an Image window, click  .
The Alarm Image window is displayed.

To display the Image window again:

- ▶ In an Image window, click  .
Live Mode or Playback Mode is displayed depending on the Mode that was displayed before.

See also

- *Alarm Mode (Alarm Display)*, page 106
- *Image window*, page 126

6.11 Starting manual recording

Main window

You can start recording for each camera manually. The quality level of alarm recording mode is used. The duration of alarm recording is configured in the Configuration Client.

If the selected camera is already recording, the quality level is changed to alarm recording mode. With VRM recording, the alarm recording is not protected.

Note: You cannot start manual recording for a DiBos camera.

To start recording:

1. Select an Image pane displaying a camera.
2. Click  .
Recording is started.

Notes:

NVR recordings only: The icon in the Image pane bar changes to  . Click to stop recording. If you do not click to stop recording, manual recording stops after the configured manual recording time. In the Timeline of the camera, the manual recording is displayed as alarm recording.

VRM recordings only: You cannot manually stop recording. The recording stops after the configured alarm recording time. In the Timeline of the camera, the pre-alarm recording is displayed as alarm recording, if pre-alarm recording is configured in Configuration Client.

See also

- *Image pane*, page 127
- *Timeline window*, page 128

6.12 Starting a pre-configured camera sequence

Main window

With a camera sequence, a group of cameras are displayed one after the other. The pre-configured camera sequences are configured in the Configuration Client and appear in the Logical Tree.

A sequence is configured to use more than one Image pane in Operator Client or on the monitor wall. If there are not enough Image panes or monitor panes to display the whole sequence, only those panes are displayed which fit into the Image window. The remaining panes are not displayed and an appropriate message is displayed.

Under the following conditions, a sequence is not being displayed:

- Video loss
- Connection to the camera lost
- No permission to display the camera
- Camera not configured

In addition, for sequences displayed on an analog monitor via a decoder, DiBos cameras cannot be displayed.

Notice!

When the configuration is changed and activated, a camera sequence (pre-configured or automatic) usually is continued after restart of the Operator Client.

But in the following cases the sequence is not continued:

A monitor where the sequence is configured to be displayed has been removed.

The mode of a monitor (single/quad view) where the sequence is configured to be displayed has been changed.

The logical number of a monitor where the sequence is configured to be displayed is changed.



To start and control a camera sequence:

1. Drag the required sequence  from the **Logical Tree** window to an Image pane or to a monitor wall.

The sequence is displayed indicated by the  symbol when running in an Image pane.

2. When running in an Image pane: Click a playback control icon of the Image window toolbar to control the sequence.

See also

- *Image pane, page 127*

6.13 Starting an automatic camera sequence

Main window

With a camera sequence, a group of cameras are displayed one after the other.

You configure the dwell time for these sequences in the **Options** dialog box (**Extras** menu, **Options...** command).

Under the following conditions, a sequence is not being displayed:

- Video loss
- Connection to the camera lost
- No permission to display the camera
- Camera not configured

In addition, for sequences displayed on an analog monitor via a decoder, DiBos cameras cannot be displayed.



Notice!

When the configuration is changed and activated, a camera sequence (pre-configured or automatic) usually is continued after restart of the Operator Client.

But in the following cases the sequence is not continued:

A monitor where the sequence is configured to be displayed has been removed.

The mode of a monitor (single/quad view) where the sequence is configured to be displayed has been changed.

The logical number of a monitor where the sequence is configured to be displayed is changed.

To start a camera sequence:

1. Select an Image pane where you want the sequence to be played.
2. Right-click a folder in the **Logical Tree** and click **Show as sequence in selected Image pane**.

The cameras of the selected folder are displayed one after the other in the selected



Image pane.  indicates that the sequence is running.

To pause a camera sequence:

- ▶ In the Image window toolbar, click .

The sequence stops playing, as indicated by .

To jump to the previous / next step of a camera sequence:

- ▶ In the Image window toolbar, click  or .

The sequence jumps to the previous or next step.

See also

- *Options dialog box, page 120*

6.14 Using one channel audio mode

Main window

You use one channel audio mode when you want to hear only one audio source assigned to a camera. You cannot activate audio for another camera.

To activate / de-activate multichannel audio mode:

1. On the **Extras** menu, click **Options....**
2. Select the **Playback audio of the selected Image pane** check box.

See also

- *Options dialog box, page 120*

6.15 Using multichannel audio mode

Main window

You use multichannel audio mode when you want to hear different audio sources at the same time. You can activate different audio sources assigned to a camera in the Image pane of each camera.

To activate / de-activate multichannel audio mode:

1. On the **Extras** menu, click **Options....**

2. Select the **Multichannel audio playback** check box.

See also

- *Options dialog box, page 120*

6.16 Using digital zoom

Main window

Every Image pane provides a digital zoom function. This digital zoom has 11 levels: 1x, 1.35x, 1.8x, 2.5x, 3.3x, 4.5x, 6x, 8.2x, 11x, 14.9x, 20.1x.

When you save a Favorites View, the current setting of the digital zoom and the image section are saved.

When you click  , the current setting of the digital zoom and the image section are used for instant playback.

When Operator Client restarts, the current setting of the digital zoom and the image section are retained.

To use digital zoom:

1. Rotate the wheel button forward or backward to zoom in or zoom out.



indicates that the digital zoom was used.

2. Drag the image to navigate to the desired image section.
3. Right-click the Image pane and click **Zoom 1:1** to return to the original size.



disappears.

Note:

You can also use the controls for digital zoom in the **PTZ Control** window.

See also

- *Favorites Tree window, page 123*
- *PTZ Control window, page 126*
- *Image pane, page 127*

6.17 Saving a single image

Main window

To save a single image:

1. Select an Image pane.



2. Click  .

A dialog box for saving the image file is displayed.

3. Select the desired directory, enter a file name, and select the desired file type. JPG and BMP are available.
4. Click **OK**.

The image is saved. The file contains additional information about the camera.

If you logged on to an Enterprise Management Server, the camera name is displayed with the name of this camera's Management Server as a prefix.

See also

- *Image pane, page 127*

6.18 Printing a single image

Main window

To print a single image:

1. Select an Image pane.

2. Click  .

A dialog box for selecting the printer is displayed.

3. Click **OK**.

The image is printed. The printout contains additional information about the camera.

If you logged on to an Enterprise Management Server, the camera name is displayed with the name of this camera's Management Server as a prefix.

See also

- *Image pane, page 127*

6.19 Switching to full-screen mode

Main window

Full-screen mode hides many control elements, for example the menu commands or the Alarm List if no alarm monitor was switched to full-screen mode. For accessing these control elements, leave the full-screen-mode.

To display the entire Image window in full-screen mode:

- ▶ On the Image window toolbar, click  .
The Image window is displayed in full-screen mode.

To leave the full-screen mode:

- ▶ Click  .

To maximize a selected Image pane:

- ▶ Right-click an Image pane and click **Maximize**.
The selected Image pane is displayed using the entire Image window.



See also

- *Image window, page 126*

6.20 Displaying or hiding the Image pane bars

Main window

To display / hide the toolbars:

- ▶ Click  to display the toolbars of the selected cameo.
- ▶ Click  to hide the toolbars of the selected cameo.

See also

- *Image window, page 126*

6.21 Displaying information on a camera

Main window

To display information:

- ▶ Right-click an Image pane with a camera assigned and click **Properties**.
A dialog box with the camera properties is displayed.

See also

- *Image pane, page 127*

6.22 Enabling video content analysis (VCA)

Main window

To enable:

- ▶ Right-click an Image pane with a camera assigned and click **Enable Content Analysis**.
The VCA overlays are displayed. This setting is retained after the next restart or re-logout of Operator Client or after closing the camera and displaying it again in an Image pane.

To disable:

- ▶ Right-click an Image pane with a camera assigned and click **Disable Content Analysis**.
The VCA overlays disappear.

6.23 Showing video content analysis (VCA) rules

Main window

To show VCA rules:

- ▶ Right-click an Image pane with a camera assigned and click **Show Content Analysis rules**.
The VCA rules are displayed.
This setting is not persistent after the next restart or re-logout of Operator Client or after closing the camera and displaying it again in an Image pane.

To hide VCA rules:

- ▶ Right-click an Image pane with a camera assigned and click **Hide Content Analysis rules**.
The VCA rules disappear.

6.24 Starting instant playback

Main window  >

You can view the recordings of a camera in an Image pane in the Live Mode.
If configured you can change the recording source.

The current setting of the digital zoom and the image section are used for instant playback.
The start time (number of seconds in the past or rewind time) for instant playback is configured in the **Options** dialog box (**Extras** menu, **Options...** command).

To start instant playback:

1. Select the required Image pane.
2. Click  .
The recording is played.
3. Switch to the desired recording source if available.
Note: After switching the recording source the rewind time can deviate from the configured value.

- ▶ To return to live image, click  .

Note: More than one Image pane with instant playback is possible, even multiple instant playbacks of the same camera.

The rewind time for instant playback is configured in the *Control tab, page 120*.

To start/stop loop playback:

- ▶ Click .

The duration of looped instant playback in the live cameo is the rewind time backwards plus the rewind time forwards from the time you click .

See also

- *Control tab, page 120*
- *Image pane, page 127*
- *Switching the recording source, page 81*
- *Options dialog box, page 120*

6.25 Assigning a camera to a monitor

Main window >  > 

You can assign IP devices to a decoder. This displays the video signal on the monitor and plays the audio signal on the speakers if connected to the decoder. DiBos and Bosch Allegiant cameras cannot be assigned this way.

To assign a camera image to a monitor:

- ▶ Drag a camera from the  window to the desired monitor in the Image pane.

6.26 Using audio mode



Main window

If available you can activate audio for a selected camera.

To hear the audio signal of multiple cameras simultaneously, activate multichannel audio mode.

You switch the audio mode in the **Options** dialog box (**Extras** menu, **Options...** command).

To activate / de-activate audio:

1. Select an Image pane.
2. Click  to de-activate or  to activate audio.

See also

- *Image pane, page 127*
- *Options dialog box, page 120*

6.27 Using the Intercom functionality

Main window > 

You can use the Intercom functionality only when Live Mode is active.

Ensure that the microphone is active on your sound card and its volume is not 0. You perform this task in the Control Panel of your workstation computer. Additionally ensure that in the recording control of your sound card only the microphone is selected, not the stereo mix. For Windows 7: Disable all input devices except the one you want to use for Intercom functionality.

The following screenshot shows an example:



If you change the setting from stereo mix to microphone after the first start of Operator Client, the setting is overridden after the next start of Operator Client.

We recommend to use a headset instead of a microphone-loudspeaker combination to avoid acoustic feedback.

The Intercom functionality only works with an encoder that has both audio-in and audio-out. Ensure that the volume settings for the encoder microphone and loudspeakers are not 0. You perform this task in Configuration Client.

To use Intercom functionality on your workstation your user group must be granted to use it. You perform this task in Configuration Client.

In the **Options** dialog box, you can configure half duplex or full duplex mode.

To use Intercom functionality:

1. Select an Image pane with an audio encoder.
2. Click  and hold the mouse button. If audio was off for this Image pane, it is switched on automatically.

The icon changes to .

Now you can talk. If configured, the other side can talk also, regardless whether the icon is clicked or not.

3. Release the mouse button. The transfer is interrupted. Audio remains on for this Image pane.

**Notice!**

An incoming auto pop-up alarm can interrupt the transfer.

See also

- *Image window, page 126*

6.28

Locking the control of a PTZ camera

Main window >

You can lock the control of a PTZ camera for other users. A user with a higher priority can take over the control and lock the camera control. A timeout can be configured for this explicit PTZ locking. If you only take over the control without manually locking it before, the control is locked for the user with lower priority for 5 seconds.

To lock a PTZ control:

1. Select one of the following items:
 - Image pane with PTZ camera
 - PTZ camera in the Logical Tree
 - PTZ camera in the Favorites Tree
 - PTZ camera in the Map window
2. Right-click the Image pane or the PTZ camera and click **Lock**.

The users with lower priorities cannot use the PTZ control any longer. On their displays a corresponding message box is displayed.

To stop the locking of the PTZ control, right-click the Image pane or the PTZ camera and click **Unlock**.

The locking ends automatically after a configured time period or when you log off.

See also

- *Image window, page 126*
- *Map window, page 125*
- *Logical Tree window, page 122*
- *Favorites Tree window, page 123*

6.29

Updating the reference image

Main window >

You can update the reference image.

To update the reference image:

1. Right-click an Image pane and click **Reference Image...**

The **Reference Image** dialog box is displayed.
2. Click **Update**.

The image of the time when you click **Update** is displayed.

See also

- *Reference Image dialog box, page 115*

6.30 Displaying a monitor group

Main window >  > 

To assign a monitor group to an image pane:

1. Drag a monitor group from the **Logical Tree** window to an image pane.
The selected monitor group is displayed in the image pane.
Or
select an image pane.
2. In the **Logical Tree** window, double-click a monitor group.
The selected monitor group is displayed in the image pane.

To assign a camera to a monitor:

1. Drag a camera from the **Logical Tree** window to a monitor.
The selected camera is displayed in the monitor.

Every assigned camera of a monitor group displays a snapshot. This snapshot helps you to identify, for example, if the correct camera is used or if the camera is reachable. The snapshot image is updated every minute.

To switch the layout of a monitor group:

- ▶ Click .

To reset the default layout settings of a monitor group:

1. Right-click the appropriate monitor group in the **Logical Tree**.
2. Select **Reset to default layout settings**.

Note: The default layout settings of a MG are the settings, that are configured in the Configuration Client for this MG.

6.31 Controlling a monitor wall

Main window > 

When you start a monitor wall, the layout which is selected on the decoder, and the logical numbers of the connected cameras are displayed.

If configured, the monitor wall is started with a pre-configured initial camera sequence. If a sequence contains more cameras than available in the selected layout, the surplus cameras are cut.

You can display cameras on a monitor wall even when your Operator Client is not connected to a Management Server.

To control:

1. Drag the monitor wall to an Image pane.
The monitor wall is displayed as an Image window.
2. Select a layout in the list.
3. Drag the desired cameras from the Logical Tree to the Image window of the monitor wall.
4. Drag the cameras to the desired Image panes of the monitor wall.

See also

- *Monitor Wall Image window, page 125*

6.32 Selecting live stream for display

Main window > 

You can select the stream of a camera for display in an Image pane. This is for example useful when the default stream is not available. In this case you can switch to another stream. In the Logical Tree you select the preferred stream to be used when the camera is displayed later.

In the Image pane of an already displayed camera you can switch the stream immediately. The stream selection in an Image pane displaying a camera is retained after restarting Operator Client without explicitly closing this Image pane before. If the default stream has been selected in an Image pane and the default stream is changed using Configuration Client, the stream used for Live display is automatically changed after restart.

You can save the stream selection of an Image pane in a view in the Favorites Tree.

When using Operator Client with a version earlier than BVMS 5.5.5 to open a view previously saved with Operator Client 5.5.5, the default stream is used.

When using Operator Client with version 5.5.5 to display a view that was saved with Operator Client with a version earlier than 5.5.5, the default stream is used.

To pre-select a preferred stream:

- ▶ In the Logical Tree, right-click a camera, point to **Preferred Stream**, and then click one of the available menu commands.

When you drag this camera to an Image pane next time, the preferred stream is used for display.

To select a stream:

- ▶ Right-click the camera image in an Image pane, point to **Select Stream**, and then click one of the available menu commands

The selected stream is used for display.

When you select **Image pane size optimized**, the resolution of the displayed camera is automatically adjusted to the size of the Image pane depending on the resolution of the used monitor.

The **Image pane size optimized** command is not available for the following cameras:

- Cameras with SD resolution
- Cameras with identical resolution on stream 1 and stream 2

See also

- *Using favorites and bookmarks, page 61*

6.33

Displaying video via low bandwidth

Main window

You can play back the recordings of a camera or view live images of a camera with Operator Client even if you have a low bandwidth network connection between BVMS and your Operator Client computer.

Transcoders do not support intelligent tracking, ROI, Intelligent Video Analytics overlays, and text data.

For using low bandwidth networks, 2 options are available:

- Hardware transcoding
- Software transcoding (only available for Live Mode)

Hardware transcoding

For hardware transcoding the VRM must be equipped with at least one transcoding device. This transcoding device is not configured in BVMS. See the VRM documentation on how to configure a transcoding device. Transcoding devices can have multiple transcoding instances. DIVAR IP 3000 and DIVAR IP 7000 are delivered each with one preconfigured transcoding instance.

Each live stream or recording needs an own transcoding instance.
Hardware transcoding is possible only for Video IP devices from Bosch connected to a VRM.
Both camera and transcoding device must be managed by the same VRM.

Software transcoding

For software transcoding you need a Mobile Video Service configured on your Management Server or your Enterprise Management Server.

In an Enterprise System only the MVS services are used that are configured in the Enterprise Management Server configuration.

To select the preferred transcoding device, use the **Options** dialog box.

To enable transcoding:

1. In the Logical Tree, right-click the desired camera, point to **Preferred Stream**, and then click to enable **Transcoding**.
2. Display the camera in an Image pane.
✓ This camera shows transcoded video.

In the toolbar of this Image pane, the  icon for hardware transcoding or the  icon for software transcoding is displayed.

If the affected camera is already displayed in an Image pane, it continues displaying untranscoded video until you close this Image pane.

If a transcoding request cannot be fulfilled, the related Image pane turns black.

To disable transcoding in Live Mode:

1. In the Logical Tree, right-click the desired camera, point to **Preferred Stream**, and then select another stream.
2. Display the camera in an Image pane.
✓ This camera shows untranscoded video.
The transcoding icon is not displayed.

If the affected camera is already displayed in an Image pane, it continues displaying transcoded video until you close this Image pane.

To disable transcoding in Playback Mode:

1. In the Logical Tree, right-click the desired camera, point to **Preferred Stream**, and then click to disable **Transcoding**.
2. Display the camera in an Image pane.
✓ This camera shows untranscoded video.
The transcoding icon is not displayed.

If the affected camera is already displayed in an Image pane, it continues displaying transcoded video until you close this Image pane.



Notice!

You can also enable or disable transcoding in an Image pane directly:

Right-click the item, point to **Select Stream**, and then click the desired menu command.

This setting only affects the selected Image pane.

This command does not affect the setting for the preferred stream in the Logical Tree.

See also

- *Options dialog box, page 120*
- *Image pane, page 127*

6.34 Using TCP for reliable connection

Main window > 

For each Video IP device from Bosch in your system you can establish a more reliable connection if required. This can be useful if you have for example connection losses due to high network load. You enable TCP for a selected camera to achieve a more reliable connection.

For all cameras of an entire workstation the system administrator can configure that the default protocol is TCP or UDP. For a single camera you can override the default protocol.

Note: From encoder firmware version 7.0, it is possible to display secure UDP for BVIP encoders. You can switch between TCP and UDP for live video of an encoder.

If you are using older firmware versions and the administrator activated the encryption for live video of an encoder in Configuration Client, TCP is selected by default and it is not possible to disable TCP.

To enable TCP:

- ▶ In the Logical Tree, right-click a camera and click **Enable TCP**.
- ✓ The connection to the camera is now established via TCP. The context menu entry of this camera changes to **Disable TCP**.

To enable UDP:

- ▶ In the Logical Tree, right-click a camera and click **Disable TCP**.
- ✓ The connection to the camera is now established via UDP. The context menu entry of this camera changes to **Enable TCP**.

To use the configured default protocol:

- ▶ In the Logical Tree, right-click a camera and click **Use default protocol (TCP)** or **Use default protocol (UDP)**. It depends on the current configuration which of these two menu commands is available.

6.35 Connecting to an unmanaged site

Main window

You can connect to an unmanaged site. All available devices of all video network devices of this site are then displayed in the Logical Tree. As soon as you log off or exit Operator Client, this connection is terminated.

To connect:

1. Right-click  .
2. Click **Connect to Site**.

As long as the device is connecting,  is displayed.

After the connection is successfully established,  is displayed. All available devices of this site are displayed in the Logical Tree.

If not all devices belonging to this site can be connected,  is displayed. You can later try to connect the remaining devices that were not connected now.

Tip: You can also double-click  to connect.

To connect remaining devices:

1. Right-click .
2. Click **Retry Connection**.

To disconnect a single site:

1. Right-click  or .
2. Click **Disconnect from Site**.

The icon changes:



All Image panes with devices belonging to this site are automatically closed.

To disconnect all sites:

- ▶ Click  .

All sites are disconnected. Partially connected sites are not disconnected.

All Image panes with devices belonging to this site are automatically closed.

See also

- *Unmanaged site, page 17*

6.36**Displaying a video analytics alarm**

Main window >

You can display the analytics viewer application of the configured video analytics platform. The analytics viewer application shows you analytics alarm details.

Prerequisites

- ▶ Drag the video analytics item  to an Image pane.

The default image of the analytics viewer application is displayed.

For displaying the analytics viewer application, a video analytics alarm must be available in the Alarm List.

To display the alarm viewer application:

- ▶ In the Alarm List, click to select a video analytics alarm. The analytics viewer application is displayed in the Image pane where you dragged the video analytics item.

6.37**Displaying Intelligent Insights widgets**

Main window

You can display an Intelligent Insights widget in an image pane.

To display an Intelligent Insights widget in an image pane:

- ▶ Drag an Intelligent Insights widget from the **Logical Tree** window to an image pane. The Intelligent Insights widget is displayed in the image pane.

7 Using maps and the PTZ cameras

This chapter provides information on how to use the **Map** window and the **PTZ Control** window.

You can view a map in the required ratio and zooming factor. Hence, you see all your devices and their places at a glance.

You can activate that the map of the camera in the selected Image pane is automatically getting the focus. This map is displayed in the **Map** window of the **Control** monitor.

Some of the features described in this chapter can be deactivated for your user group, your Enterprise User Group or your Enterprise Account.

7.1 Displaying a map

Main window

You can display a map in the **Map** window or in an Image pane.



Notice!

A map displayed in an Alarm Image pane is optimized for display and contains only the initial view of the basic .dwf file.

Depending on your configuration, a map can display blinking and colored hot spots. Each hot spot indicates that a specific state change of the corresponding device has occurred.

To view a map in the map window:

- ▶ Drag a map from the Logical Tree to the  tab, wait until the **Map** window is displayed, and drop the map on the **Map** window.
The map is displayed.

To view a map in an Image pane:

- ▶ Drag a map from the **Logical Tree** window to an Image pane.
The map is displayed in the Image pane.

See also

- *Map window, page 125*

7.2 Controlling PTZ cameras

Main window >  tab

You can zoom and control the cameras in the **PTZ Control** window or in the Image pane. The digital zoom function is not available for dome and pan/tilt cameras.



Notice!

When controlling a MIC 500 PTZ camera, focus near and focus far are permuted. You can switch the behavior directly on the device.

Controlling/zooming cameras in the PTZ Control window:

1. Select the required Image pane.
2. Click the various control elements in the **PTZ Control** window to control the camera.

To move to a preposition of a PTZ camera on a map:

1. Display a map containing a PTZ camera hot spot in an Image pane.

- Right-click a PTZ camera located on a map, point to **PTZ positions**, and then click the desired preposition command.
The camera moves the focus to the selected preposition.

To lock the control of a PTZ camera on a map:

- Display a map containing a PTZ camera hot spot in an Image pane.
- Right-click a PTZ camera located on a map and click **Lock**.
The PTZ control of this camera is locked for other users.
- To unlock: Right-click the locked PTZ camera and click **Unlock**.

See also

- *PTZ Control window, page 126*

7.3 Using in-window control of a camera

Main window

After you have assigned a PTZ camera to an Image pane, you can use the camera control functions directly in this Image pane.

To use the pan and tilt function:

- Move the cursor on the Image pane which displays a PTZ camera.

The cursor changes to .

- Press and hold the mouse button.

The cursor changes to .

To pan and tilt the image slowly, move the mouse slightly in the desired direction.

To pan and tilt more quickly, move the mouse further.

To use the optical zoom function:

- To zoom in, rotate the wheel button forward.
- To zoom out, rotate the wheel button backward.

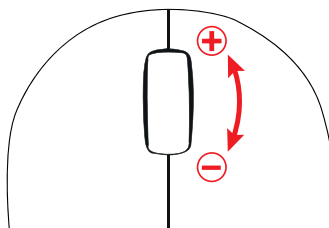

See also

- *Image pane, page 127*

7.4 Using the ROI function



Main window >  tab

You can use ROI with a fixed HD camera.

You can zoom and control the cameras in the **PTZ Control** window or in the Image pane.





Notice!

The system administrator must configure the ROI function in Configuration Client.

To use ROI:

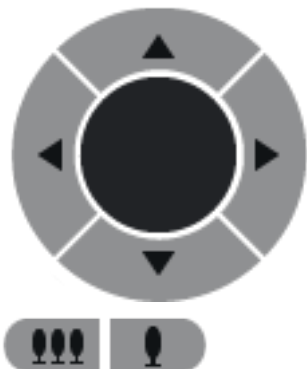
1. Use the following PTZ controls:



2. Additionally you can use the digital zoom ( ). But this does not save network bandwidth.
Or
3. Use the in-window controls.

See also

- *Region of Interest (ROI), page 21*

7.5 Using Intelligent Tracking



Main window >  tab

You can use Intelligent Tracking with a PTZ camera or with a fixed HD camera (each camera with ROI enabled).

To use Intelligent Tracking:

1. Right-click the Image pane of the camera and click **Enable Content Analysis**.
 2. Click **Auto** or **Click** to enable Intelligent Tracking.
- ✓ The camera follows an object that moves into the camera image.

See also

- *Intelligent Tracking, page 22*

8 Using favorites and bookmarks

This chapter provides information on how to use the Favorites Tree and the Bookmark Tree.

Favorites Tree

You can add every item of the Logical Tree to a view in the Favorites Tree to create your own subset of the Logical Tree. At any time you can display the view or add or delete devices in a view.

When saving a view in the Favorites Tree, you save the following settings:

- The assignment of cameras or other objects to Image panes
- The Image pane pattern
- The current setting of the digital zoom
- The image section
- The selected stream (only available for Live Mode)

Bookmark Tree

You can save a time period of live view or a recording in a bookmark. A bookmark saves a start and an end time, the cameras assigned to Image window at this time, and the entire Image

pane pattern. A time period of 0 seconds is possible. Bookmarks are saved in the  pane. Deleting a bookmark does not affect the corresponding recordings. You cannot add or remove cameras from a bookmark. To change a bookmark, load it, make your changes and save it. If a recording is deleted, the corresponding bookmark is not synchronized. If loaded, a black Image pane is displayed.

If you have logged on to an Enterprise Management Server, the camera name is displayed with the name of this camera's Management Server as a prefix.

Note: Do not add more than 4 cameras in one bookmark to avoid performance issues when loading the bookmark.

See also

- *Favorites Tree window, page 123*
- *Selecting live stream for display, page 53*

8.1 Adding items to the Favorites Tree

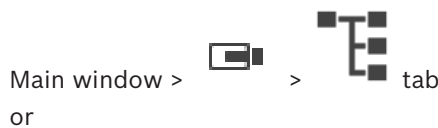

You can add each item of the Logical Tree to the Favorites Tree. This allows you to define your own subset of the Logical Tree.



To add an item:

- ▶ Right-click an item and click **Add To Favorites**.

See also

- *Logical Tree window, page 122*
- *Favorites Tree window, page 123*

8.2 Creating/editing views

Main window >  >  tab
or

Main window >  >  tab

After having assigned cameras, maps, and HTML files to Image panes, you can save this assignment and the Image pane pattern in a view in the Favorites Tree.

To create a new view:

1. Arrange the cameras in the Image window in Live Mode and in Playback Mode.
2. If desired, use the digital zoom and select an image section.
When displaying a view, the live image of the camera is displayed in Live Mode and the recorded video of the camera is displayed in Playback Mode.

3. In the Image window toolbar, click  .

A new view  is added. Enter a name for the new view.

Limitation for unmanaged sites: You can create a view of cameras from maximum 20 unmanaged sites.

To display a view:

- ▶ Double-click the view or right-click the view and click **Load Image pane view**.
The assignment saved in this view is displayed in the Image window.



Notice!

The maximum number of Image pane rows displayed in the Image window is configured in the BVMS Configuration Client. If this number has been changed since the last log off from Operator Client and the number of Image pane rows in the saved view exceeds the maximum set by system parameter, the saved view cannot be displayed and a warning is displayed. You can display the view without the excess rows.

Displaying a view for unmanaged sites

When you load a view for cameras from unmanaged sites, the assignment saved in this view is displayed in the Image window and the unmanaged sites are connected automatically. If the connection takes more than 3 seconds the **Connecting** dialog box is displayed showing the connection progress.

- ▶ To cancel the connection process, click **Cancel**.
No further unmanaged sites are connected and no further camera images are loaded. The unmanaged sites which have already been connected remain connected and the camera images which have already been loaded remain open.

If there are connection problems, the unmanaged sites which could not be connected are displayed in the **Connecting** dialog box.

- ▶ After the connection process has finished, click **OK**.

If the number of already connected unmanaged sites and unmanaged sites assigned to the Favorite view exceeds the maximum number of 20 connected sites, a warning message is displayed.

- ▶ Click **No** to cancel.

Or

Click **OK** to continue.

If you continue, the unmanaged sites which are already connected but are not assigned to the Favorite view are disconnected and only unmanaged sites which are assigned to the Favorite view are connected.

To edit a view:

1. Double-click the view  which you want to edit.
2. Make the required changes, for example assign cameras to Image panes.
3. Right-click the required view and click **Update Image pane view**.

To rename a view:

1. Right-click the required view  and click **Rename**.
2. Enter the name of the view and press ENTER.

To delete a view:

- ▶ Right-click the view and click **Remove**.
The view is removed from the Favorites Tree.

See also

- *Favorites Tree window, page 123*

8.3

Adding a bookmark

Main window >  > Assign desired cameras to Image panes
or

Main window >  > Assign desired cameras to Image panes

To add a bookmark:

1. Using the Hairline, select the time period on the Timeline.
 2. In the toolbar, click .
The **Add Bookmark** dialog box is displayed.
If you logged on to an Enterprise Management Server, the camera name is displayed with the name of this camera's Management Server as a prefix.
 3. The selected time period is copied to the appropriate fields.
 4. Make changes if required.
 5. Click **OK**.
- ✓ The bookmark is saved in the Bookmark Tree.

See also

- *Add Bookmark dialog box, page 124*

8.4 Editing a bookmark

Main window >  >  tab
or

Main window >  >  tab

To edit a bookmark:

1. Right-click a bookmark and click **Edit bookmark**.
The **Edit Bookmark** dialog box is displayed.
 2. Make changes if required.
 3. Click **OK**.
- ✓ The bookmark is saved in the Bookmark Tree.

See also

- *Add Bookmark dialog box, page 124*

8.5 Loading a bookmark

Main window >  >  tab
or

Main window >  >  tab

To display a bookmark:

- ▶ Drag a bookmark to the Image window. The entire Image window layout saved in the bookmark is displayed in the Timeline. The Hairline is positioned at the start time of the bookmark.
- ✓ The previous Image window is overwritten.



Notice!

The maximum number of Image pane rows displayed in the Image window is configured in the BVMS Configuration Client. If this number has been changed since the last log off from Operator Client and the number of Image pane rows in the saved bookmark exceeds the maximum set by system parameter, the saved view cannot be displayed and a warning is displayed.

You can display the view without the excess rows.

See also

- *Bookmarks window, page 123*

8.6 Exporting bookmarks

Main window > 
or

Main window > 

For detailed information on the various fields, see the Online Help for the appropriate application window.

To export bookmarks:**To export bookmarks:**

1. Click the  tab.
2. Right-click a bookmark.
3. To export a single bookmark click **Export bookmark**.
The **Export bookmark** dialog box is displayed.
Or
To export multiple bookmarks click **Export multiple bookmarks**.
The **Export Video** dialog box is displayed.
4. Make the appropriate settings.
If you want to encrypt the exported files, type in a password and confirm this password.
5. Click **Export**.
The size of the recordings to be exported is estimated. Overlappings of recordings are subtracted. If free space is not enough, an error message is displayed.
The authenticity of the export is automatically verified.
The recordings are exported to the selected data medium.
6. If available, click **Verification Details** to display the **Authenticity Verification Result** dialog box. If no authentication issues were found, the **Verification Details** button is inactive.

See also

- *Export Bookmark dialog box, page 137*
- *Export Multiple Bookmarks dialog box, page 139*
- *Timeline window, page 128*

9 Managing recorded videos

This chapter provides information on how to manage recordings.

Some of the features described in this chapter can be deactivated for your user group.

9.1 Selecting a time zone

Main window



Notice!

Ensure that the time on all computers of your system is set correctly according to each time zone where the computers are located.

Management Server or unmanaged site and all connected devices including encoders, decoders, VRM Server computers, DiBos and DVR devices must be in the same time zone. Operator Client computers (including Client SDK and Cameo SDK) and Configuration Client computers can be in other time zones than the Management Server or unmanaged site. If your Operator Client is located in another time zone than one or more connected Management Server or unmanaged site, you can select one of the following time displays:

- Your local time
- UTC
- Time zone of the Management Server or unmanaged site you are connected to

The Image panes displaying a camera (live and playback) always show the time of the corresponding Management Server or unmanaged site.

In the Logical Tree,  is displayed on the device icon of each server or unmanaged site that do not share the time zone that is currently selected in the Operator Client:

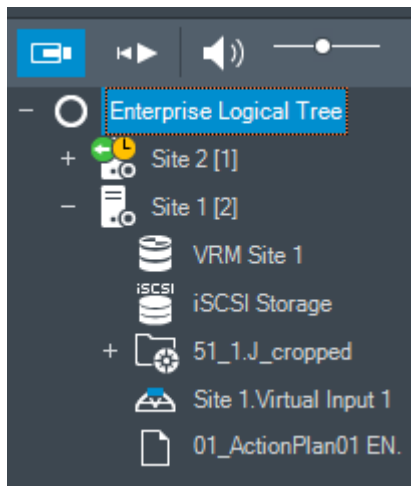

You can select the time zone of a server or unmanaged site for displaying this time zone in Operator Client.

To select the time zone:

1. In the Logical Tree, right-click a server icon to select the time zone of this server.
2. In the time zone selector list, select the desired entry.
 - **Operator Client Time:** Operator Client
 - **UTC**

- **UTC-x:** time zone of each available Management Server

The time based on the selected time zone is displayed in the menu bar:

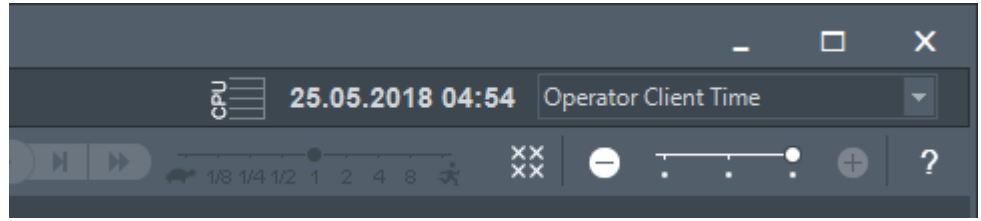

See also

- *Logical Tree window, page 122*

9.2 Playing recorded videos

Main window >  >  tab

Note:

Bosch Allegiant cameras are not recorded within BVMS.

To play recorded videos:

1. Assign a camera to an Image pane.
2. Switch to the desired recording source if available.
3. Use a Timeline control for the required playing option.

See also

- *Timeline window, page 128*
- *Using the Timeline, page 67*
- *Switching the recording source, page 81*

9.3 Using the Timeline

Main window >  >  tab

You can access a specific time in the Timeline via the Hairline.

To navigate in the Timeline:

- ▶ Click somewhere in the Timeline.
The images of the selected point in time are displayed in the Image window.

Or:

1. In the date and time field, enter the required values.

2. Click  .

The Hairline jumps to this time. The images of the entered point in time are displayed in the Image window. Use a Timeline control for the required playing option.

You can select a time period in the Timeline using the Hairline. You can use this selection for further tasks such as for exporting video data.

- ▶ Drag the bottom handles of the Hairline to select a time period or to change this selection.
Drag the upper handles to move the hairline or selection.

See also

- *Timeline window, page 128*

- *Playing recorded videos, page 67*

9.4 Changing the playback speed

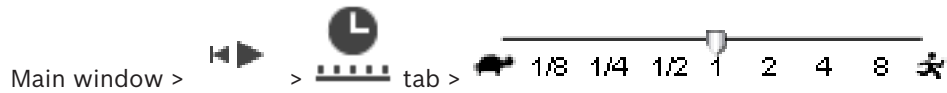

To change the playback speed for playing a video forward or reverse:

- ▶ Move the slider to the left to decrease the playback speed, and to the right to increase the playback speed.

Note: If you set the playback speed to 4x or higher, not all frames will be displayed.

See also

- *Timeline window, page 128*



9.5 Restricting video

Main window >  > **Timeline** menu

You can restrict the recordings of cameras connected to the following DIVAR devices:

- DIVAR AN 3000
- DIVAR AN 5000
- DIVAR hybrid
- DIVAR network

When restricted, an unauthorized user cannot display the recordings of these cameras.

The DIVAR devices can be connected to BVMS either locally under  or as an unmanaged site under .

For restricting you need the corresponding permission.



Notice!

Unrestricting / unprotecting a selected time period can possibly unrestrict / unprotect the entire contiguous restricted / protected time period of this camera, even outside the selected time period.

To restrict:

1. Using the Hairline, select the time period of one or more DIVAR cameras on the Timeline.
2. Right-click this time period and click **Restrict video....**
The **Restrict Video** dialog box is displayed.
3. Click **Restrict**.

A message box is displayed showing detailed information on the time period that is effectively restricted. Usually this time period is larger than the selected time period. The video data is restricted. In the Timeline, restricted video is indicated with red diagonal stripes: .

Note:

To remove the restriction, select the restricted period in the Timeline, right-click, and then click **Unrestrict video....**

See also

- *Restrict Video dialog box, page 132*
- *Unrestrict Video dialog box, page 133*

9.6 Protecting video

Main window >  >  tab

You can protect the images of the displayed cameras against being overwritten or deleted.



Notice!

You cannot protect the data of a local storage device.

- Using the Hairline, select the time period on the Timeline.
- Right-click this time period and click **Protect video....**
The **Protect Video** dialog box is displayed.
The selected time period is copied to the **Start:** and **End:** fields.
If required, change the values.
- Click **Protect**.
The video data is protected. In the Timeline, protected video is indicated with white diagonal stripes: 

Note:

To remove the protection, select the protected period in the Timeline, right-click and click **Unprotect video....**

See also

- *Protect Video dialog box, page 133*
- *Timeline window, page 128*

9.7 Deleting video data

Main window >  >  tab

Note: You cannot restore deleted video data.

You can delete video data from the beginning of the recording to the position of the hairline. The video data of all cameras available in the Timeline are deleted.

VRM recordings: Protected recordings are not deleted.

NVR recordings: When protected recordings are available, the deleting is not started.



Notice!

You cannot delete the data of a local storage device.

To delete video:

- Move the Hairline to the desired position on the Timeline.
On the **Timeline** menu, click **Delete video....**
The **Delete Video** dialog box is displayed.
- Make the appropriate settings.
For detailed information on the various fields, see the Online Help for the appropriate application window.

- ▶ Click **Delete**.
Confirm the warning message.
When deleting is finished, click **Done**.

See also

- *Delete Video dialog box, page 131*
- *Timeline window, page 128*
- *Delete Video dialog box, page 134*

9.8 Verifying the authenticity of video data

Main window >  >  tab

You can verify the authenticity of the recordings of all cameras displayed in the Image window.

To authenticate:

1. Using the Hairline, select the time period on the Timeline.
2. Right-click this time period and click **Verify authenticity...**
The **Verify Authenticity** dialog box is displayed.
The current Hairline value in the Timeline is copied to the **Start:** and **End:** lists. If required, change the values.
3. Click **Verify** to start authentication.
The **Authenticity Verification Result** dialog box is displayed that shows the result of the verification process.

See also

- *Authenticity Verification Result dialog box, page 141*
- *Verification of authenticity, page 34*

9.9 Exporting video data

Main window > 
or

Main window > 



Notice!

You cannot export the data of a local storage device.

Exporting video data is possible as follows:

- *Exporting bookmarks, page 71*
- *Exporting a time period, page 71*
- *Exporting a single search entry, page 72*

Exports can be created in different formats:

- **Native format**
- ASF
- MOV

Exports can be saved to different targets:

- HDD
- CD/DVD

For detailed information on the various fields, see the Online Help for the appropriate application window.

See also

- *Export Bookmark dialog box, page 137*
- *Export Multiple Bookmarks dialog box, page 139*
- *Export Video dialog box, page 135*
- *Timeline window, page 128*
- *Video Search Results window, page 143*
- *Authenticity Verification Result dialog box, page 141*

9.9.1

Exporting bookmarks

To export bookmarks:

1. Click the  tab.
2. Right-click a bookmark.
3. To export a single bookmark click **Export bookmark**.
The **Export bookmark** dialog box is displayed.
Or
To export multiple bookmarks click **Export multiple bookmarks**.
The **Export Video** dialog box is displayed.
4. Make the appropriate settings.
If you want to encrypt the exported files, type in a password and confirm this password.
5. Click **Export**.
The size of the recordings to be exported is estimated. Overlappings of recordings are subtracted. If free space is not enough, an error message is displayed.
The authenticity of the export is automatically verified.
The recordings are exported to the selected data medium.
6. If available, click **Verification Details** to display the **Authenticity Verification Result** dialog box. If no authentication issues were found, the **Verification Details** button is inactive.

9.9.2



Exporting a time period



Notice!

Only available in Playback Mode.

To export a time period:

1. Click the  tab.
2. Using the Hairline, select the time period on the Timeline.
3. Click .
The **Export Video** dialog box is displayed.
The selected time period is copied to the **Start:** and **End:** fields.
4. Make the appropriate settings.
If you want to encrypt the exported files, type in a password and confirm this password.

5. Click **Export**.
The size of the recordings to be exported is estimated. Overlappings of recordings are subtracted. If free space is not enough, an error message is displayed.
The authenticity of the export is automatically verified.
The files are exported to the selected data medium.
6. If available, click **Verification Details** to display the **Authenticity Verification Result** dialog box.



9.9.3 Exporting a single search entry



Notice!

Only available in Playback Mode.

To export a single search entry:

1. Perform a search for video data.
2. Click the  tab or the  tab.
3. Click an entry in the search result list.
4. Click .
The **Export Video** dialog box is displayed.
5. Make the appropriate settings.
If you want to encrypt the exported files, type in a password and confirm this password.
6. Click **Export**.
The authenticity of the export is automatically verified.
The entry is exported to the selected data medium.
7. If available, click **Verification Details** to display the **Authenticity Verification Result** dialog box.

9.10 Providing a password for export

Main window >  > **Timeline** menu > **Export video...** command > **Export Video** dialog box
or

Main window >  > Right-click a bookmark > **Export bookmark** command > **Export bookmark** dialog box
or

Main window >  tab > Right-click a bookmark > **Export multiple bookmarks** command > **Export Video** dialog box

You can provide a password for each native export that you perform using Operator Client.

To provide a password:

1. Click to select **Native format**.
2. Click to select **Encrypt Export**.
3. Type in a password and confirm it.

4. Make the appropriate settings.
5. Click **Export**.
The encrypted export is performed.
When loading this export, the operator must type in the password.

See also

- *Export Bookmark dialog box, page 137*
- *Export Multiple Bookmarks dialog box, page 139*
- *Export Video dialog box, page 135*

9.11 Exporting into a single file

Main window >  > **Timeline** menu > **Export video...** command > **Export Video** dialog box

You can export video recordings into a single ZIP file.

To export:

1. Enter the desired start and end times.
2. Click to select **Export as single ZIP file**.
3. Make the appropriate settings.
If you want to encrypt the exported files, type in a password and confirm this password.
4. Click **Export**.
The size of the recordings to be exported is estimated. If free space is not enough, an error message is displayed.
The authenticity of the export is automatically verified.
The recordings are exported and the export is added to a single ZIP file.
5. If available, click **Verification Details** to display the **Authenticity Verification Result** dialog box.

**Notice!**

You cannot load a ZIP export file in Operator Client.

See also

- *Export Video dialog box, page 135*

9.12 Loading exported video

Main window > 

**Notice!**

You cannot load a ZIP export file in Operator Client.

Export formats

- Block exports (info), created with the VRM eXport Wizard
- Not encrypted Export files (*.info), created with the BVMS Operator Client
- Encrypted Export files (*.encr) , created with the BVMS Operator Client

Additional Information

Video exports created with the VRM eXport Wizard are displayed as `info` file. With the VRM eXport Wizard it is possible to export a large volume of data. The VRM eXport Wizard is part of the BVMS release ZIP within the folder Bonus. For more information see the VRM eXport Wizard Software Manual.

You can load exported recordings for display. Before you can load an export which was exported into a single ZIP file, extract this ZIP file.

1. On the **Timeline** menu, click the **Load exported video...** command.
The dialog box for opening export files is displayed.
2. Select the required file and click **Open**.
Encrypted export files have the `.encr` extension, not encrypted files have the `.info` extension, block exports are displayed as `info` file.
If you select a file with the `.encr` extension, type in the password for this export.

The loaded video is displayed in the  window.

For playing the loaded video, expand the entry and drag a camera to an Image pane.

If the camera has been exported on a computer where Operator Client was logged on to an Enterprise Management Server, the camera name is displayed with the name of this camera's Management Server as a prefix.

The Export Tree entries are removed when you exit the Operator Client.

3. For removing the exported video, right-click  and click **Unload Export**.

See also

- *Exports window, page 125*
- *Timeline window, page 128*

9.13

Performing a Forensic Search (only VRM recordings)

Main window >  >  tab > Select an Image pane

You can check the video in the selected Image pane for motion. Forensic Search allows you to search for specific properties.

Forensic search is only available for VRM recordings.



Notice!

Forensic Search must be enabled on your workstation.

1. Select the Image pane where you want to find motion.
2. Using the Hairline, select the time period on the Timeline and select the corresponding Image pane.

3. Click .
The **Forensic Search** dialog box is displayed.
The selected time period is copied to the **Start:** and **End:** fields.

If required, change the values. Click .

4. In the **Algorithm:** list, select an Intelligent Video Analytics entry.

5. In the **Surveillance Tasks** field, configure your Forensic Search.
See the user documentation of the Intelligent Video Analytics version that you are using.
6. Click **Search** to start the Forensic Search.



The window with the matching entries is displayed.

7. For playing the corresponding video, double-click the entry. The corresponding video is displayed.

See also

- *Forensic Search dialog box, page 131*
- *Timeline window, page 128*

9.14 Enabling video content analysis (VCA)

Main window

To enable:

- ▶ Right-click an Image pane with a camera assigned and click **Enable Content Analysis**.
The VCA overlays are displayed. This setting is retained after the next restart or re-logout of Operator Client or after closing the camera and displaying it again in an Image pane.

To disable:

- ▶ Right-click an Image pane with a camera assigned and click **Disable Content Analysis**.
The VCA overlays disappear.

9.15 Finding motion



Main window > > Select an Image pane

You can check the video in the selected Image pane for motion.

To find motion:

1. Select the Image pane where you want to find motion.
2. Using the Hairline, select the time period on the Timeline.
3. Click . The **Motion Search** dialog box is displayed. The selected time period is copied to the **Start:** and **End:** fields.
If required, change the values.
4. If required, select **Display Grid**. A grid is placed above the image. You can select every cell in the grid for searching.
5. Select the cells you want to check for motion. To select the cells, drag an area.
The selected area is displayed in half transparent yellow.
To clear a selected area, drag the selected area again.
6. Click **Start Search**. The search results for the selected Image pane are listed in the window.
7. For playing the corresponding video, double-click the entry. The corresponding video is displayed.



See also

- *Motion Search dialog box, page 130*
- *Motion Search Results window, page 142*
- *Timeline window, page 128*

9.16 Finding logbook entries

Main window > **Tools** menu > **Find in logbook...** command > **Please select a Server** dialog box > **Select Search Parameters** dialog box

In the Logbook, you can search for particular events, alarms, devices, and strings of events. You can save the search criteria as a filter. If you select another time zone, the date and time display of the Logbook search results is changed accordingly.

To find Logbook entries:

1. In an Enterprise System, select the desired Management Server for searching.
2. In the **Filter** list, select a pre-defined filter if available.
A filter contains all the settings that you make in this dialog box.
You can save, load, and delete the selected filter. You can reset the settings of the selected filter.
3. In the **Date and Time** field, enter start date and time and end date and time for the search process.
4. In the **Result Count** list, limit the number of matching entries that result from the search.
5. Click **Add** to limit the search to specific events.
6. Click **Add/Edit** to specify search criteria for text data.
7. In the **Alarms** field, select search criteria to limit the search to specific alarms.
8. Click **Add** to limit the search to specific devices.
9. In the **Details** field, type a search string. You can use * as a wildcard.
10. In the **User name** field, type a user name to search for.
11. Click **Search**.
The **Logbook results:** dialog box with the matching entries is displayed.

See also

- *Select Search Parameters dialog box, page 116*
- *Logbook Results: dialog box, page 120*
- *Search Conditions dialog box, page 119*
- *Device Selection dialog box, page 119*
- *Event Selection dialog box, page 120*

9.16.1 Finding logons to an unmanaged site

Main window > **Tools** menu > **Find in logbook...** command > **Please select a Server** dialog box > **Select Search Parameters** dialog box

You can find a logon event on a workstation that is configured in another BVMS as an unmanaged site. If a user of Operator Client accesses this workstation using an unmanaged site, this event is logged as an **Operator Logon** event.

To find a logon:

1. Click **Add** to limit the search to specific events.
2. In the **Event Selection** dialog box, expand **Events and Alarms**, expand **System Devices**, expand **User Actions**.
3. Click to select **Operator Logon** and **Operator Logoff**.
4. Click **Search**.
The **Logbook results:** dialog box with the matching entries is displayed.

9.16.2 Finding Person Identification events and alarms

It is possible to search for a specific person in all Person Identification events and alarms in order to find past recordings of the specific identified person.

You can search for the following text data in order to find a specific person:

- Person name
- Person group
- Person ID

For detailed information on the various fields, follow the link to the appropriate chapter below.

See also



- *Finding logbook entries, page 76*
- *Select Search Parameters dialog box, page 116*
- *Search Conditions dialog box, page 119*
- *Logbook Results: dialog box, page 120*
- *Erasing text data from Person Identification logbook entries, page 79*

9.17 Finding recorded video

Main window >  > **Tools** menu > **Find video...** command > **Please select a Server** dialog box > **Select Search Parameters** dialog box
or

Main window >  >  >  > **Please select a Server** dialog box (if required) > **Select Search Parameters** dialog box
or

Main window >  >  > Click  > **Please select a Server** dialog box (if required) > **Search for Text Data** dialog box

Main window >  >  > Select time period with Hairline > Click 
For detailed information on the various fields, see the Online Help for the appropriate application window.

To find video data:

1. Enter or select the required search criteria.
2. Click **Search**.



The window with the matching entries is displayed.

3. For playing the corresponding video, double-click the entry. The corresponding video is displayed.

If you searched for text data, the text data pane is automatically opened in the Image pane.

See also

- *Select Search Parameters dialog box, page 116*
- *Logbook Results: dialog box, page 120*
- *Timeline window, page 128*
- *Video Search Results window, page 143*
- *Search for Text Data dialog box, page 119*

9.18 Displaying text data

Main window >  > Right-click an Image pane > **Text Data Show Bottom** or **Text Data Show Right**

Main window > Right-click an Image pane > **Text Data Show Bottom** or **Text Data Show Right**



Notice!

The system administrator must configure the recording of text data in Configuration Client.

You can display recorded text data in the text data pane.

The text values are displayed in the left column, the names of the text fields are displayed in the right column.

To find recordings with text data, click .

To display text data:

1. Move the hairline to a time position when an event with text data has been recorded.
2. In the Timeline, start the playback.

The text data is displayed in the text data pane.

The following screenshot shows an example:

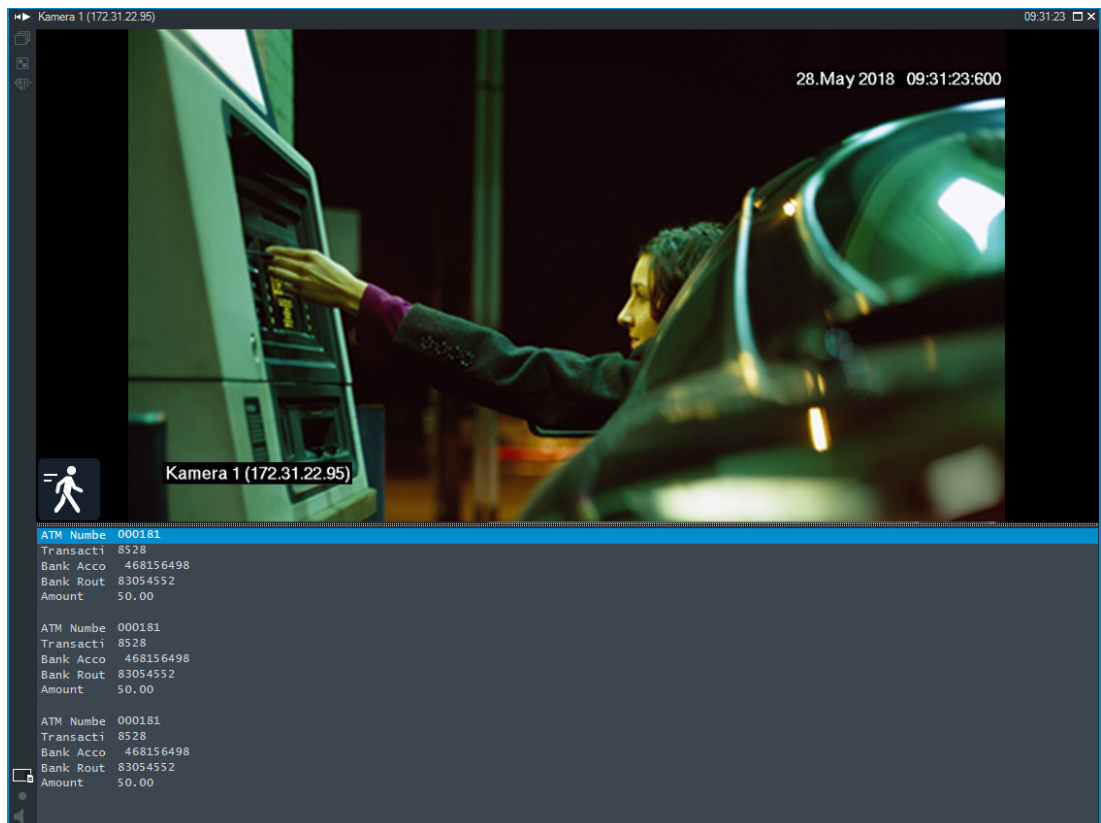

See also

- [Search for Text Data dialog box, page 119](#)
- [Finding recorded video, page 77](#)

9.19 Erasing text data from Person Identification logbook entries

Tools > Erase data from logbook...

In order to erase person-related data if requested, you can erase text data from logbook entries.

You can erase the following person-related text data:

- Person name
- Person group
- Person ID

Note: It is only possible to erase all person-related text data from a logbook entry at once.

To erase text data from logbook entries:

1. Click **Erase text data from logbook...**
The **Select search parameters for erasing text data** dialog box is displayed.
2. Click **Add/Edit** to specify search criteria for text data.
3. In the **Data Field Name** column, select the appropriate entry.
4. In the **Comparative Value** column, type a search string. You can use * as a wildcard.
5. Click **OK**.
6. In the **Date and Time** field, enter start date and time and end date and time for the search process.
7. In the **Result Count** list, limit the number of matching entries that result from the search.
8. Click **Search**.
The **Logbook entries for erasing text data** dialog box with the matching entries is displayed.
9. Select the appropriate logbook entries.
You can select multiple entries by pressing the CTRL- or the SHIFT-key.
10. Click **Erase text data from selected entries**.
11. Click **OK**.
The text data of the selected entries is erased.

Select search parameters for removing text data dialog box

Add/Edit

Click to display the **Search Conditions** dialog box.

Remove

Click to remove the selected condition entry.

Remove All

Click to remove all condition entries.

Search

Click to start the search. The **Logbook entries for erasing text data** dialog box is displayed.

See also

- *Finding logbook entries, page 76*
- *Finding Person Identification events and alarms, page 76*

9.20 Displaying video via low bandwidth

Main window

You can play back the recordings of a camera or view live images of a camera with Operator Client even if you have a low bandwidth network connection between BVMS and your Operator Client computer.

Transcoders do not support intelligent tracking, ROI, Intelligent Video Analytics overlays, and text data.

For using low bandwidth networks, 2 options are available:

- Hardware transcoding
- Software transcoding (only available for Live Mode)

Hardware transcoding

For hardware transcoding the VRM must be equipped with at least one transcoding device. This transcoding device is not configured in BVMS. See the VRM documentation on how to configure a transcoding device. Transcoding devices can have multiple transcoding instances. DIVAR IP 3000 and DIVAR IP 7000 are delivered each with one preconfigured transcoding instance.

Each live stream or recording needs an own transcoding instance.

Hardware transcoding is possible only for Video IP devices from Bosch connected to a VRM. Both camera and transcoding device must be managed by the same VRM.

Software transcoding

For software transcoding you need a Mobile Video Service configured on your Management Server or your Enterprise Management Server.

In an Enterprise System only the MVS services are used that are configured in the Enterprise Management Server configuration.

To select the preferred transcoding device, use the **Options** dialog box.

To enable transcoding:

1. In the Logical Tree, right-click the desired camera, point to **Preferred Stream**, and then click to enable **Transcoding**.
2. Display the camera in an Image pane.
 - ✓ This camera shows transcoded video.

In the toolbar of this Image pane, the  icon for hardware transcoding or the  icon for software transcoding is displayed.

If the affected camera is already displayed in an Image pane, it continues displaying untranscoded video until you close this Image pane.

If a transcoding request cannot be fulfilled, the related Image pane turns black.

To disable transcoding in Live Mode:

1. In the Logical Tree, right-click the desired camera, point to **Preferred Stream**, and then select another stream.
2. Display the camera in an Image pane.
 - ✓ This camera shows untranscoded video.The transcoding icon is not displayed.

If the affected camera is already displayed in an Image pane, it continues displaying transcoded video until you close this Image pane.

To disable transcoding in Playback Mode:

1. In the Logical Tree, right-click the desired camera, point to **Preferred Stream**, and then click to disable **Transcoding**.
2. Display the camera in an Image pane.
 - ✓ This camera shows untranscoded video.The transcoding icon is not displayed.

If the affected camera is already displayed in an Image pane, it continues displaying transcoded video until you close this Image pane.



Notice!

You can also enable or disable transcoding in an Image pane directly: Right-click the item, point to **Select Stream**, and then click the desired menu command. This setting only affects the selected Image pane. This command does not affect the setting for the preferred stream in the Logical Tree.

See also

- Options dialog box, page 120
- Image pane, page 127

9.21 Switching the recording source

Main window >

If configured, you can change the recording source. An icon for changing the recording source displays the current status.

Example: indicates that Secondary VRM recording is displayed.

To switch:

- ▶ Click an icon for changing the recording source, for example .
- The icon changes for example to .
- The Timeline displays the recording of the selected source.

See also

- Icons used, page 109
- Playing recorded videos, page 67
- Starting instant playback, page 49

9.22 Connecting to an unmanaged site

Main window

You can connect to an unmanaged site. All available devices of all video network devices of this site are then displayed in the Logical Tree. As soon as you log off or exit Operator Client, this connection is terminated.

To connect:

1. Right-click .
2. Click **Connect to Site**.

As long as the device is connecting, is displayed.

After the connection is successfully established, is displayed. All available devices of this site are displayed in the Logical Tree.

If not all devices belonging to this site can be connected, is displayed. You can later try to connect the remaining devices that were not connected now.

Tip: You can also double-click to connect.

To connect remaining devices:

1. Right-click .
2. Click **Retry Connection**.

To disconnect a single site:

1. Right-click  or .
2. Click **Disconnect from Site**.

The icon changes:



All Image panes with devices belonging to this site are automatically closed.

To disconnect all sites:

- ▶ Click .

All sites are disconnected. Partially connected sites are not disconnected.

All Image panes with devices belonging to this site are automatically closed.

See also

- *Unmanaged site, page 17*

10 Handling events and alarms

This chapter provides information on how to handle alarms. Some of the features described in this chapter can be deactivated for your user group.



Notice!

A map displayed in an Alarm Image pane is optimized for display and contains only the initial view of the basic .dwf file.

See also

- *Managing Person Identification alarms, page 88*
- *Controlling access control functions, page 92*



10.1 Accepting an alarm

Main window >  >  tab
or

Main window >  >  tab

You can accept a single alarm or multiple alarms for clearing or starting a workflow.

To accept an alarm:

1. Select the desired alarm entry and click  .
2. For returning to the image window, click  .

When an alarm is accepted, several things happen simultaneously:

- The alarm is removed from alarm lists of all other users.
- If not already displayed, an alarm image window replaces the Live Image window on the monitor that has been enabled for alarms.
- The alarm content (live video, instant playback video, or site maps) is shown in a row of alarm image panes in the alarm image window.
- If there is a workflow associated with the alarm, the workflow button  is enabled. You can now clear the alarm or start a workflow. If the alarm has been configured to "force workflow", then you must complete the workflow before you can clear the alarm.

To display an alarm camera on a monitor:

- ▶ Drag the camera image from its alarm image pane to a monitor group.

To accept all alarms on a map:



1. Display a map containing a camera hot spot in an Image pane.
2. Right-click a camera located on a map, and click **Accept all alarms of this device**. All alarms of this device are accepted. The alarm list displays the accepted alarms accordingly.

See also

- *Alarm List window, page 143*

10.2 Adding comments to an alarm

Main window >  >  tab > Select the desired alarm > ✓
or

Main window >  >  tab > Select the desired alarm > ✓
You can only comment an alarm after you have accepted it.



To add a comment to an alarm:

1. Click  .
The Workflow dialog box is displayed for entering a comment and displaying the action plan for this alarm. If no action plan is assigned to the alarm, the dialog box only displays the **Comment:** field.
2. In the **Comment:** field, type your comment.
3. Click **Close**.
4. Clear the alarm.
The comment is added as a separate entry in the Logbook and added to the alarm entry in the Logbook.

See also

- *Alarm List window, page 143*

10.3 Clearing an alarm

Main window >  >  tab
or

Main window >  >  tab

To clear an alarm:

- ▶ Select the desired alarm entries and click  .
If the alarm has the Comment or Force Workflow attribute, you cannot clear the alarm directly. In these cases you must first display the action plan and enter a comment.
The alarm is cleared and removed from your Alarm List.
If no other alarms are currently being displayed, the Alarm Image window is closed and the Image pane is displayed.

To clear all alarms on a map:

1. Display a map containing a camera hot spot in an Image pane.
2. Right-click a camera located on a map, and click **Clear all alarms of this device**.
All alarms of this device are cleared. The Alarm List displays the cleared alarms accordingly.

See also

- *Alarm List window, page 143*

10.4 Customizing the Alarm List window

Main window >  >  tab
or

Main window >  >  tab

To sort the table:

1. Click a column heading.
The arrow in the column heading indicates whether the table is sorted in ascending or descending order.
2. To change the sorting order, click the column heading again.

To add or remove columns:

- ▶ Right-click the column heading and click a marked entry to remove the corresponding column or click an unmarked entry to add the corresponding column.

To change the sequence of columns:

- ▶ Drag a column title and move it to the required position.

To change the column width:

1. Point to the right border of the column heading. The pointer becomes a double-headed arrow . Drag the column border to the left or the right.
or
2. To quickly make the column wide enough to show all of its contents, double-click the right border of the column heading.

See also

- Alarm List window, page 143

10.5 Displaying the Live Image window

Main window >  > Alarm Image window
or

Main window >  > Alarm Image window

You can switch to the Live or Playback Image window when the Alarm Image window is displayed.

To display the Image window:

- ▶ In an Alarm Image window, click . The Image window is displayed.

To start/stop loop playback:

- ▶ Click .

See also

- Alarm List window, page 143
- Image window, page 126

10.6 Switching alarm modes of Alarm Image window

In the Alarm Image window you can switch the alarm mode. The following modes are available:

- Multi-row Alarm mode

- Single View mode

To switch to Multi-row Alarm mode:

- ▶ Click .

To switch to Single View mode:

- ▶ Click 
 - or
 - double-click somewhere in the Alarm Image window
 - or
 - double-click on a specific Alarm Image pane.



Notice!



If you double-click somewhere in the Alarm Image window, the first Image pane in the Alarm Image pane row will switch to Single View mode. If you double-click on a specific alarm Image pane in the Alarm Image window this specific alarm Image pane will switch to Single View mode.

See also

- *Alarm Mode (Alarm Display), page 106*

10.7

Starting a workflow

Main window >  >  tab
or

Main window >  >  tab

To start a workflow:

1. Select the required alarm entry and click .
- If this alarm has been configured to force a workflow, the action plan is displayed (if configured for this alarm). Additionally you can enter a comment if this is configured.
2. Perform the required actions.
3. Clear the alarm.

See also

- *Alarm List window, page 143*

10.8

Un-accepting an alarm

Main window >  >  tab
or

Main window >  >  tab

When you recall the acceptance of an alarm, it returns to Active state in your Alarm List, and it reappears in the Alarm Lists of all users that originally received the alarm.

To "un-accept" an alarm:

- ▶ Select the accepted alarm entry and click  .
The alarm is displayed as active again.

See also

- *Alarm List window, page 143*

10.9**Triggering a user event**

Main window >  > Click 

You can trigger a user event for a selected Management Server of an Enterprise System that has been configured in Configuration Client.

- ▶ Right-click the desired  and click the desired user event command.
- ✓ The event is triggered.

11 Managing Person Identification alarms

When you accept a Person Identification alarm, information about the identified person is displayed in the image pane.

Person Identification information

Person group	Person group is the group that a person is assigned to.
Person image(s)	The default image and all available images from the Person Identification device are displayed.
Person name	The person name is the name of the identified person.
Confidence factor	The confidence factor is a measure of the degree of correctness a person is identified by the system in percentage (0 is no correctness, 100 is full correctness).

See also

– *Handling events and alarms, page 83*

11.1 Managing persons for a Person Identification alarm

Tools > Manage persons... > Manage persons dialog box

The **Manage persons** dialog box allows you to add persons, assign person groups, add images to existing persons and export persons.



Notice!

Person Identification only supports JPEG files.

To add/import a person:

1. Select a person.
 2. Click  to add an image of a person.
Or
drag an image of a person from your file explorer to a person group or the **All** tab.
- ✓ This image is assigned as the default image of the person.

To add images to an existing person:

1. Select a person.
The default image and all available images of the person are displayed.
2. Click  in the images window to add more images to the person.

To assign a new default image:

1. Move the mouse over the appropriate image.
The **Set as default** command is displayed.
2. Click the **Set as default** command.
The image is assigned as default image.

To assign a person group to a person:

1. Select a person.
For every new person the **Default person group** value is already selected.
2. Click in the **Default person group** field.
3. Select the appropriate person group you want to assign to the person.

To export persons:

1. Select a person.
2. Click  to export the person to the file explorer.

**Notice!**

is disabled, if the **All** tab is selected. Select the **Default person group** tab or any other available person group tab to export persons.

To delete a person:

1. Select a person.
2. Click .

To delete multiple persons:

1. Select a person
2. Press the CTRL-key and select multiple persons.
3. Click .

To delete single person images:

1. Select the appropriate image.
2. Click .

Note: If you delete the default image, the next image is automatically assigned as the default image.

12 Controlling intrusion panel functions

You can control several intrusion panel functions from within the Operator Client.

12.1 Switching off alarm sirens

Main window

You can switch off alarm sirens of an intrusion panel area if you have the corresponding permission.

To switch off an alarm siren:

- ▶ In the Logical Tree or in a map, right-click the desired area  and click **Silence Bells**. The alarm siren is silent.

12.2 Operating doors

Main window

You can control the following intrusion panel states of a door from within Operator Client:

- Secure a door.
- Unsecure a door. The state changes to locked.
- Lock a door.
- Unlock a door. You can lock or secure an unlocked door.
- Cycle a door.

The system administrator can limit the permission for each of these functions to specific user groups.

To lock a door means that a cardholder can open the door using the card.

To unlock a door, means that the door is open for anybody.

To secure a door means that nobody can open the door, even not the cardholders.

To cycle a door means to unlock a locked door for a few seconds, then lock it again.

To operate:

- ▶ Right-click a door in the Logical Tree or in a map and click the required command.

The following commands are available:

- **Lock / Unlock**
- **Secure / Unsecure**
- **Cycle**

Note: The context menus for operating a door are not available when the state of this door is unknown.

See also

- *Icons used, page 109*

12.3 Bypassing a point

Main window

You can change the state of a point to the **Bypassed** state within Operator Client.

The system administrator can limit the permission for this function to specific user groups.

When you unbyypass a point, you change its state back to normal.

To bypass a point means that this point cannot send any alarm. To unbyypass a point means that this point can send alarms. Pending alarms are also sent if available.

To bypass or unbyypass:

- ▶ Right-click a point in the Logical Tree or in a map and click the required command.

Note: The context menus for bypassing and unbypassing are not available when the state of the device is unknown.

See also

- *Icons used, page 109*

12.3.1

Arming an area



Main window

You can control the following intrusion panel states of an area from within Operator Client:



- Arm an area.
- Disarm an area.
- Force the arming of an area that is not ready for arming.

The system administrator can limit the permission for each of these functions to specific user groups.



To arm an area:

- ▶ In the Logical Tree, right-click the desired disarmed area () and click **Arm**. The icon for an armed area () is displayed.

To disarm an area:

- ▶ In the Logical Tree or in a map, right-click the desired armed area () and click **Disarm**. The icon for a disarmed area () is displayed.

To force the arming of an area:

- ▶ In the Logical Tree or in a map, right-click the desired disarmed area () and click **Force Arm**. The icon for an armed area () is displayed.

Note: The context menus for arming and disarming are not available when the state of the device is unknown.

13 Controlling access control functions

You can control several access control functions from within the Operator Client.

See also

– *Handling events and alarms, page 83*

13.1 Granting and denying access



Notice!

Only **Access requested** alarms with high priority will automatically pop-up in the image window.

To grant or deny access:

Click  to accept the **Access requested** alarm.
An alarm-timer is now running, that shows how much time is left.

▶ Click  to grant access.
Or

click  to deny access.



Notice!

Once the timer has run out, the system will automatically deny access for this specific request.

14 Using a CCTV keyboard

This chapter describes how to use BVMS Operator Client with a Bosch IntuiKey keyboard or a KBD Universal XF keyboard.

14.1 Using KBD Universal XF keyboard



Notice!

Refer to the Instructions Manual delivered with your KBD-Universal XF keyboard available on the online product catalog.

You can use the KBD-Universal XF keyboard as a USB keyboard for BVMS.















Attach the keyboard template for BVMS to the keyboard before use.

You can configure the keyboard for use by a left-handed operator. Refer to the Instructions Manual delivered with the KBD Universal XF keyboard.

14.1.1 KBD Universal XF keyboard user interface

The following table lists the icons on the keyboard template and their respective function.

Icon	Function
	Trigger a user event, only available with single Management Server
	Audio on / off Blinking indicates that the function is enabled.
	Start /stop alarm recording
	Toggle between Live Mode and Playback Mode Blinking indicates that the function is enabled.
	Toggle selected Image pane between Live Mode and instant playback. Blinking indicates that the function is enabled.
	Load a sequence. Enter a valid sequence number and confirm with OK . Use the playback buttons for controlling the sequence. Blinking indicates that the input of a number is required.
	Reduce number of Image panes
	Increase number of Image panes
	Full-screen on / off
	Maximize / restore selected Image pane
ESC	Breaks the entering of a number. Press twice to close selected Image pane.

Icon	Function
	Confirm a number entry.
	PTZ mode on/off. Blinking indicates that the function is enabled.
	Select a PTZ position. Enter a valid number of a preset and confirm with OK . Blinking indicates that the input of a number is required.
	Focus far
	Focus near
	Iris closed
	Iris open
	Analog monitor mode on /off. Enter a valid monitor number, press OK , enter a valid camera number and press OK . Blinking indicates that the input of a number is required.
	Set the default Management Server, only available when you log on to Operator Client as a user of an Enterprise User Group. Enter a valid server number and confirm with OK . Blinking indicates that the input of a number is required.
	Fast backward (stepwise)
	Play backward
	Pause
	Play
	Fast forward (stepwise)

When a button is not illuminated, it does not have any function. All illuminated buttons have a function.

When a button is blinking, its function is active, for example Playback button is blinking means that the Playback Mode is active. Press the button to toggle to the other state, for example pressing the blinking Playback button switches to Live Mode.

Enter a number and confirm with OK to display the respective camera in the selected Image pane.

14.2 Bosch IntuiKey keyboard user interface



Notice!

Every input on the keyboard is cleared after some seconds if no further input is made.

This chapter describes the user interface of the Bosch IntuiKey keyboard. The following illustration shows the various interface elements of the keyboard:

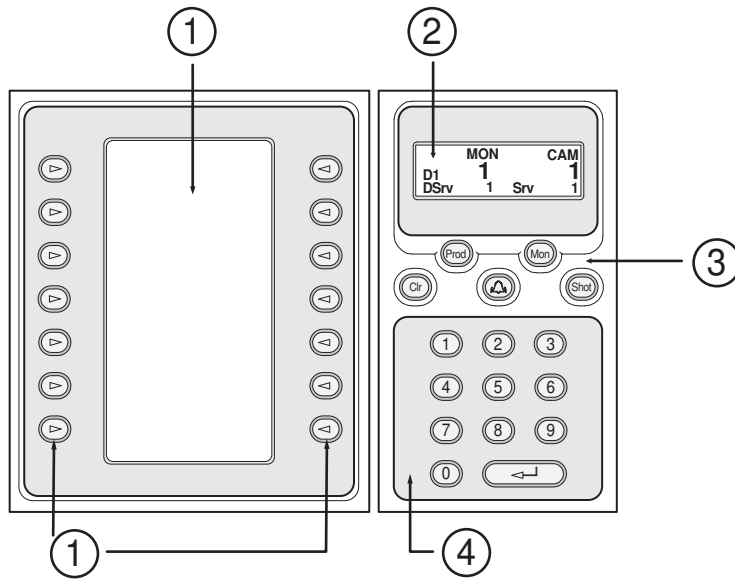

1	Softkeys and softkey display	Allow you to use a fixed set of commands or to control the Logical Tree. The commands displayed in the softkey display change depending on the operation mode.
2	Status display	Changes dynamically and displays information on the current operation mode.
3	Function keys	<p>Allow you to control certain functions directly.</p> <p>Prod: Starts a scan process to find the connected workstation. If scanning is successful: In the softkey display, Terminal and Keyboard Control menus are displayed. For selecting BVMS, press the Terminal softkey.</p> <p>Mon: Allows you to enter a monitor number (digital or analog monitor).</p> <p>Clr: Clears any numeric entry or has a Back-function.</p> <p>: Currently not supported.</p> <p>Shot: Allows you to select a camera pre-position or to leave Selection mode.</p>
4	Numeric keypad with ENTER key	Allows you to enter logical numbers. The number is displayed in the status display.

Unless preceded by pressing the Mon or Shot key, a numeric entry is interpreted as a logical camera number. The camera with the entered number is displayed in an Image pane or an analog monitor.

14.2.1

Status display

The status display changes dynamically to display information about the keyboard's present mode of operation.

The following illustration shows the various elements of the status display:

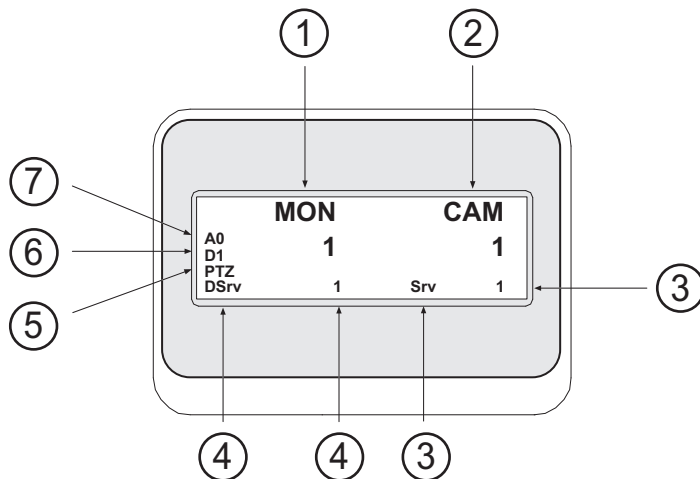

1	Monitor	Displays the selected analog monitor or Image pane number.
2	Camera	Displays the selected camera number.
3	Server	Displays the server number of the Management Server where the currently selected camera is configured.
4	Default Server	Displays the server number of the Management Server of an Enterprise System that the keyboard uses as default server. The Logical Tree of this server is displayed in the Tree Mode.
5	PTZ / JOGSHUTTLE	Displays the current operation mode.
6	D1	Displays the selected computer monitor number.
7	A0	Displays the selected analog monitor number.

14.3

Using a Bosch IntuiKey keyboard connected to a workstation

A keyboard connected to a BVMS workstation offers a wide variety of features. Both the analog and the digital mode are available.

If the keyboard is connected to a decoder, the feature set is reduced. Only the analog mode is available.

When connected to a workstation that is using an Enterprise System, you must first select the desired Management Server and then the camera configured on this Management Server.

See also

- *Bosch IntuiKey keyboard user interface, page 95*

14.3.1 Starting the keyboard

The keyboard must be connected to a COM port of a workstation.

1. Start the Operator Client on the workstation.
2. Press the Prod button.
The keyboard scans for connected devices.
3. Press the Terminal softkey.
The Selection Mode is displayed.

14.3.2 Entering operation modes

You can use the keyboard in the following modes:

- Selection Mode
This mode allows you to select an Image pane by moving the joystick in the desired direction.
- PTZ Mode
This mode allows you to control fixed and PTZ cameras, maps, and documents in Live Mode.
- Jogshuttle Mode
This mode allows you to control cameras in instant playback or in Playback Mode.

To enter Selection Mode:

1. Start the Operator Client and the keyboard.
or
2. Press ENTER to leave PTZ or Jogshuttle Mode and to return to Selection Mode.

To enter PTZ Mode:

1. Select a PTZ camera.
2. Press Shot.
To start a preposition, press Shot again, press the number of a preposition, and press ENTER.

To enter Jogshuttle Mode:

1. Start Playback Mode.
2. Press Shot.

To leave PTZ or Jogshuttle Mode:

- ▶ Press ENTER to leave PTZ or Jogshuttle Mode and start Selection Mode again.

14.3.3 Displaying cameras

Enter a numeric command to display the camera with this logical number in the active Image pane or analog monitor.

To display cameras of an Enterprise System, select the Management Server where these cameras are configured.

Toggling between analog mode and workstation mode

- ▶ Press Mon twice.

Displaying a camera in a computer monitor

1. Switch to a digital mode.
2. Press Mon, press 1 - 4 to select the desired workstation monitor, press the number of the desired Image pane and press ENTER.
The numbering of Image panes is from left to right and top to bottom.

- Press the desired number of the camera and press ENTER.
The desired camera is displayed.
Example: Press Mon, 412, and ENTER. Then press 7 and ENTER. Camera 7 is displayed on the 12th Image pane on workstation monitor 4.

Selecting a Management Server of an Enterprise System:

- Press NEXT.
- Press the  softkey and enter the server number.
The server number is configured in Configuration Client in the **Server Number** list.
When you now enter the logical number of a camera, a camera configured on this Management Server is displayed.

Displaying a camera in an analog monitor

- Switch to analog mode.
- Press Mon, press the number of the desired monitor, and press ENTER.
Monitor numbers are configured in the Configuration Client.
- Press the desired number of the camera and press ENTER.
The desired camera is displayed.
Example: Press Mon, 3, and ENTER. Then press 4 and ENTER. Camera 4 is displayed in the 3rd analog monitor.



Notice!

When you call up a PTZ camera by a numeric command, the system automatically enters PTZ mode.

14.3.4

Using the joystick

In Selection Mode, the joystick allows you to use the following features:

- Tilt the joystick to select an Image pane.

In PTZ Mode, the joystick allows you to use the following features:

- Twist the joystick to zoom in and out.
- Tilt the joystick to pan and tilt a PTZ camera.
- Use Focus and Iris buttons for a PTZ camera.

In Jogshuttle Mode, twist the joystick to use the following features:

- Play forward/backward as long as you twist.
- Change the playback speed: Speed depends on the degree of rotation.
- Stop a video when playing.

In Jogshuttle Mode, tilt the joystick to use the following features:

- Tilt up / down when video is stopped: Play forward / backward.
- Tilt up / down when video is playing: Set the playback speed.
- Tilt right / left: Pause and step forward / backward.

In Jogshuttle Mode, the Focus and Iris buttons allow you to use the following feature:

- Press Focus or Iris to move the hairline in the Timeline forward or backward. Focus moves the hairline for a larger amount of time forward or backward, Iris moves the hairline for a smaller amount of time forward or backward.

Playback Mode :

- To lock the system in the current playback speed, press the Shot button while twisting the joystick.

14.3.5

Using softkeys

The following operation modes are available:

- Tree Mode
You use this operation mode to control devices that are available in the Logical Tree of the Operator Client.
- Command Mode
You use this operation mode to send commands like switch to Playback Mode.

To toggle between Tree Mode and Command Mode:

1. In the Tree Mode: Press the left Level Up softkey as often as needed to display the root level and then press the Exit softkey to display the Command Mode.
or
2. In the Command Mode: Press the Tree Mode softkey.

To use the Logical Tree mode:

- ▶ Switch to the Tree Mode.

Right side of the softkey display:

- ▶ Press a softkey to control the item (e.g. display a camera or switch a relay).
When you press a map or a folder (black background), it moves to the left side. The right side displays the its content.

Left side of the softkey display:

1. Press a softkey on the left side to select a folder or a map and to display its content on the right side of the softkey display.
To display a map, press the softkey once to mark it (with a rectangle) and press the softkey again to display it in the selected Image pane.
2. Press Level Up to enter the next upper level of the Logical Tree.
3. Press UP to move the selection upward or DOWN to move downward.



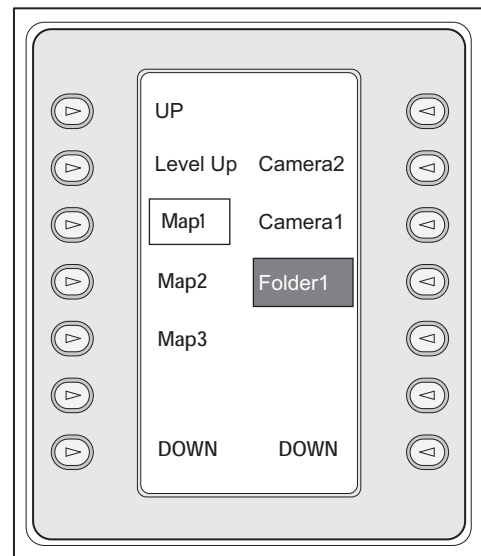
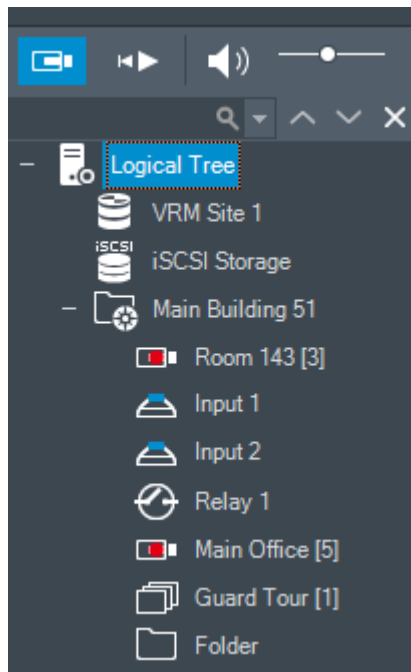









The following figures show an example of a Logical Tree and its representation on the softkey display of the keyboard.

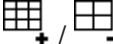

To use the Command Mode:

1. Switch to the Command Mode.
2. Press a softkey to execute the desired command.

The following commands are available:

- : Load a sequence. In the **Status Display**, enter the sequence number.
 - : Sequence play, pause
 - : Sequence step forward / backward
 - : Maximize / restore selected Image pane
 - : Close selected Image pane
 - : Toggle between Live Mode and Playback Mode
 - : Toggle selected Image pane between Live Mode and instant playback
 - : Show more Image pane rows / Show fewer Image pane rows
- Note:** You cannot display more Image pane rows than the configured maximum, which is set by a parameter in the BVMS Configuration Client.
-  / **REC**: Start /stop alarm recording
 - : Audio on / off
 - **NEXT**: Switch to next page
 - : Trigger a user event (1-4), only available with single Management Server
 - : Set the default Management Server, only available when you log on to Operator Client as a user of an Enterprise User Group.
 - : Image pane bars on / off
 - : Full-screen on / off

You cannot display more Image pane rows than the configured maximum, which set by a parameter

14.4 Using a Bosch IntuiKey keyboard connected to a decoder

A keyboard connected to decoder gives you access to the Management Server without Operator Client software. Hence, you must log on. Only the analog mode is available.

14.4.1 Starting the keyboard

After starting the keyboard you must log on to the Management Server.



Notice!

Only BVMS users with number-only user names and number-only passwords can use the analog mode of a Bosch IntuiKey keyboard.

The user must have access rights for the decoder connected to the Bosch IntuiKey keyboard.

To start the keyboard:

- ▶ Press the Terminal softkey.
- The following logon display is shown:

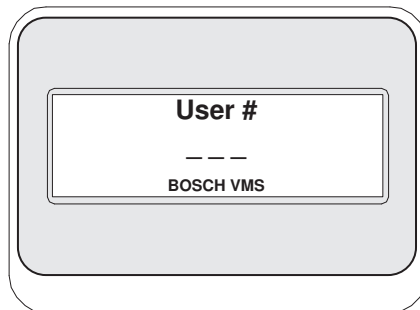

- ▶ Enter the user name.

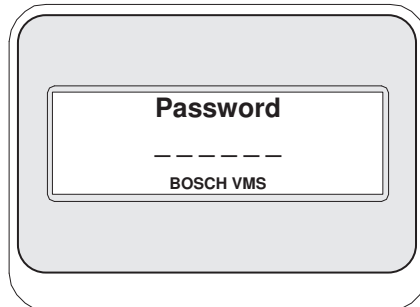

After successful logon, the Terminal and Keyboard Control softkeys are displayed in the softkey display.

14.4.2 Displaying cameras

1. Press Mon, press the number of the desired monitor, and press ENTER.
Monitor numbers are configured in the Configuration Client.
2. Press the desired number of the camera and press ENTER.
The desired camera is displayed.
Example: Press Mon, 3, and ENTER. Then press 4 and ENTER. Camera 4 is displayed in the 3rd analog monitor.
When the selected monitor displays a PTZ camera, the keyboard switches to PTZ mode automatically.

14.4.3 Using the joystick

The joystick allows you to use the following features:

- Twist the joystick to zoom in and out.
- Tilt the joystick to pan and tilt a PTZ camera.
- Use Focus and Iris buttons for a PTZ camera.

14.4.4 Using softkeys

The following operation mode is available:

- Command Mode

To use the Command Mode:

- ▶ Press a softkey to execute the desired command.

The following commands are available:

- Start /stop alarm recording
- Log off

15 User interface

This chapter contains information on all windows available in Operator Client of BVMS.

See also

- *Live Mode, page 102*
- *Playback Mode, page 104*
- *Alarm Mode (Alarm Display), page 106*

15.1 Live Mode

Main window > 

You automatically access Live Mode every time you log on.

Allows you to move, resize, or hide all control elements as required.

You can right-click to display the context menu.

If an incoming alarm has a lower priority than the currently displayed Image window, the







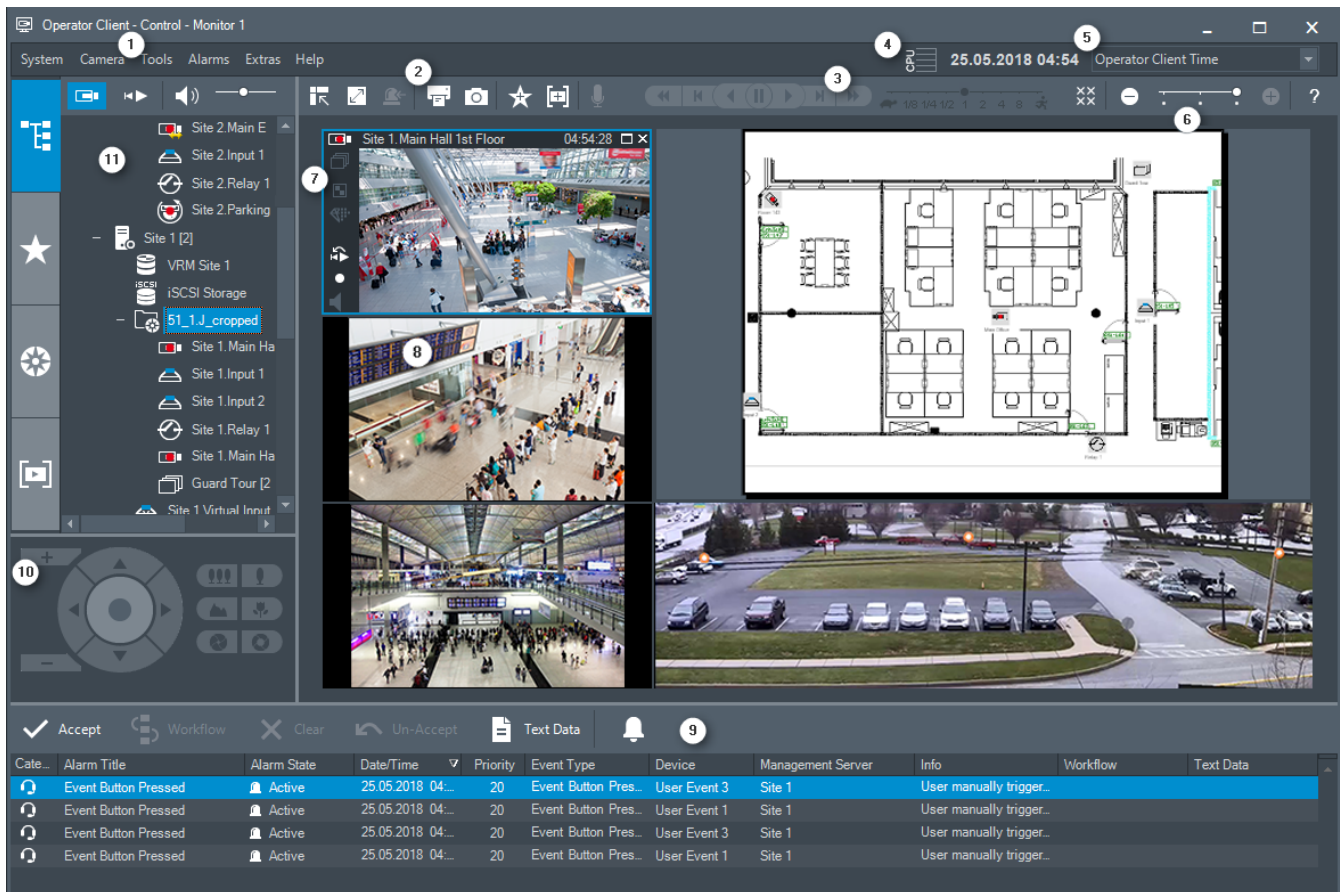

tab starts blinking and indicates an alarm.

If an incoming alarm has a higher priority than the currently displayed Image window, the incoming alarm is automatically being displayed (automatic pop-up alarm).



1	Menu bar	Allows you to select a menu command.
2	Toolbar	Displays the available buttons. Point to an icon to display a tooltip.

3	Playback controls	Allows you to control instant playback or a camera sequence or alarm sequence.
4	Performance meter	Displays the CPU usage and the memory usage.
5	Time zone selector	Select an entry for the time zone to be displayed in most time related fields. Only available if at least one Management Server or unmanaged site in the Logical Tree is located in another time zone as your Operator Client.
6	Controls for Image panes	Allows you to select the required number of Image panes and to close all Image panes.
7	Image window	Displays the Image panes. Allows you to arrange the Image panes.
8	Image pane	Displays a camera, a map, an image, a document (HTML file).
9	 Alarm List window	Displays all alarms that the system generates. Allows you to accept or clear an alarm or to start a workflow, for example, by sending an E-mail to a maintenance person. The Alarm List is not being displayed, when the connection to the Management Server is lost.
10	 PTZ Control window	Allows you to control a PTZ camera.
11	 Logical Tree window	Displays the devices your user group has access to. Allows you to select a device for assigning it to an Image pane.
	 Favorites Tree window	Allows you to organize the devices of the Logical Tree as required.
	 Bookmarks window	Allows to manage bookmarks.
	 Map window	Displays a site map. Allows you to drag the map to display a particular section of the map. If activated, a map is displayed automatically for each camera displayed in an Image pane. In this case, the camera must be configured on a map.

See also

- *Menu commands, page 112*
- *Logical Tree window, page 122*
- *Favorites Tree window, page 123*
- *PTZ Control window, page 126*
- *Image window, page 126*

- Image pane, page 127
- Alarm List window, page 143

15.2 Playback Mode

Main window > 

You can right-click to display the context menu.







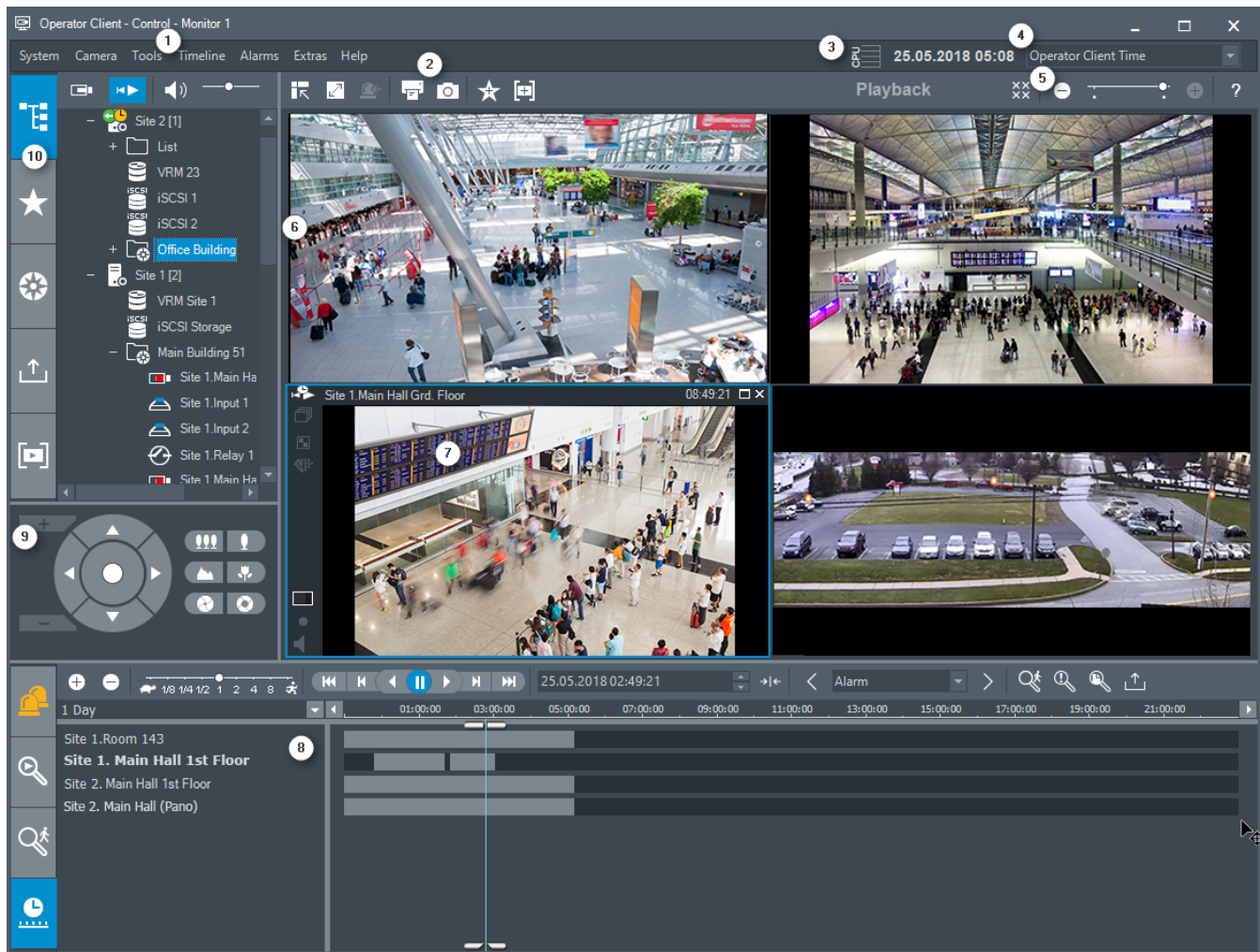

If an incoming alarm has a lower priority than the currently displayed Image window, the





tab starts blinking and indicates an alarm. If the incoming alarm has a higher priority than the Live or Playback Image window, the Alarm Image window is displayed automatically. The priorities are configured in the Configuration Client.



1	Menu bar	Allows you to select a menu command.
2	Toolbar	Displays the available buttons. Point to an icon to display a tooltip.
3	Performance meter	Displays the CPU usage and the memory usage.

4	Time zone selector	<p>Select an entry for the time zone to be displayed in most time related fields.</p> <p>Only available if at least one Management Server or unmanaged site in the Logical Tree is located in another time zone as your Operator Client.</p>
5	Controls for Image panes	<p>Allows you to select the required number of Image panes and to close all Image panes.</p>
6	Image window	<p>Displays the Image panes. Allows you to arrange the Image panes.</p>
7	Image pane	<p>Displays a camera, a map, an image, a document (HTML file).</p>
8	 <p>Timeline window</p>	<p>Allows to you to navigate through the recorded videos.</p>
	 <p>Motion Search Results window</p>	<p>Allows you to find motion.</p>
	 <p>Video Search Results window</p>	<p>Allows you to find recorded videos.</p>
	 <p>Alarm List window</p>	<p>Displays all alarms that the system generates.</p> <p>Allows you to accept or clear an alarm or to start a workflow, for example, by sending an E-mail to a maintenance person.</p> <p>The Alarm List is not being displayed, when the connection to the Management Server is lost.</p>
9	 <p>Monitors window (only available if at least one monitor group has been configured)</p>	<p>Displays the configured monitor groups.</p> <p>Allows you to switch to the next or previous analog monitor group if available.</p> <p>Note: The Monitors tab is not visible if your Operator Client is connected to more than one Management Server.</p>
	 <p>PTZ Control window</p>	<p>Allows you to control a PTZ camera.</p>
10	 <p>Logical Tree window</p>	<p>Displays the devices your user group has access to. Allows you to select a device for assigning it to an Image pane.</p>
	 <p>Favorites Tree window</p>	<p>Allows you to organize the devices of the Logical Tree as required.</p>

	 <p>Map window</p>	<p>Displays a site map. Allows you to drag the map to display a particular section of the map.</p> <p>If activated, a map is displayed automatically for each camera displayed in an Image pane. In this case, the camera must be configured on a map.</p>
	 <p>Exports window</p>	<p>Allows you to load exported video data to display it or to search for particular data.</p>
	 <p>Bookmarks window</p>	<p>Allows to manage bookmarks.</p>

See also

- *Menu commands, page 112*
- *Logical Tree window, page 122*
- *Favorites Tree window, page 123*
- *Exports window, page 125*
- *Map window, page 125*
- *PTZ Control window, page 126*
- *Image window, page 126*
- *Image pane, page 127*
- *Timeline window, page 128*
- *Motion Search Results window, page 142*
- *Video Search Results window, page 143*
- *Alarm List window, page 143*

15.3 Alarm Mode (Alarm Display)

Main window >  or  >  tab > Select an alarm > 

The Alarm Image window displays live or instant playback video from a camera to be displayed in case of an alarm. The Alarm Image window is displayed automatically if the incoming alarm has a higher priority than the Live or Playback Image window. The priorities are configured in the Configuration Client.

Allows you to view the alarm cameras. Alarm cameras are configured in the Configuration Client.

If an incoming alarm has a lower priority than the currently displayed Image window, the



tab starts blinking and indicates an alarm.

When more alarms are displayed than Alarm Image rows are available, the display in the last row is sequenced. You can control the alarm sequence with the playback controls in the Alarm Image window toolbar. You cannot perform instant playback in the last row.







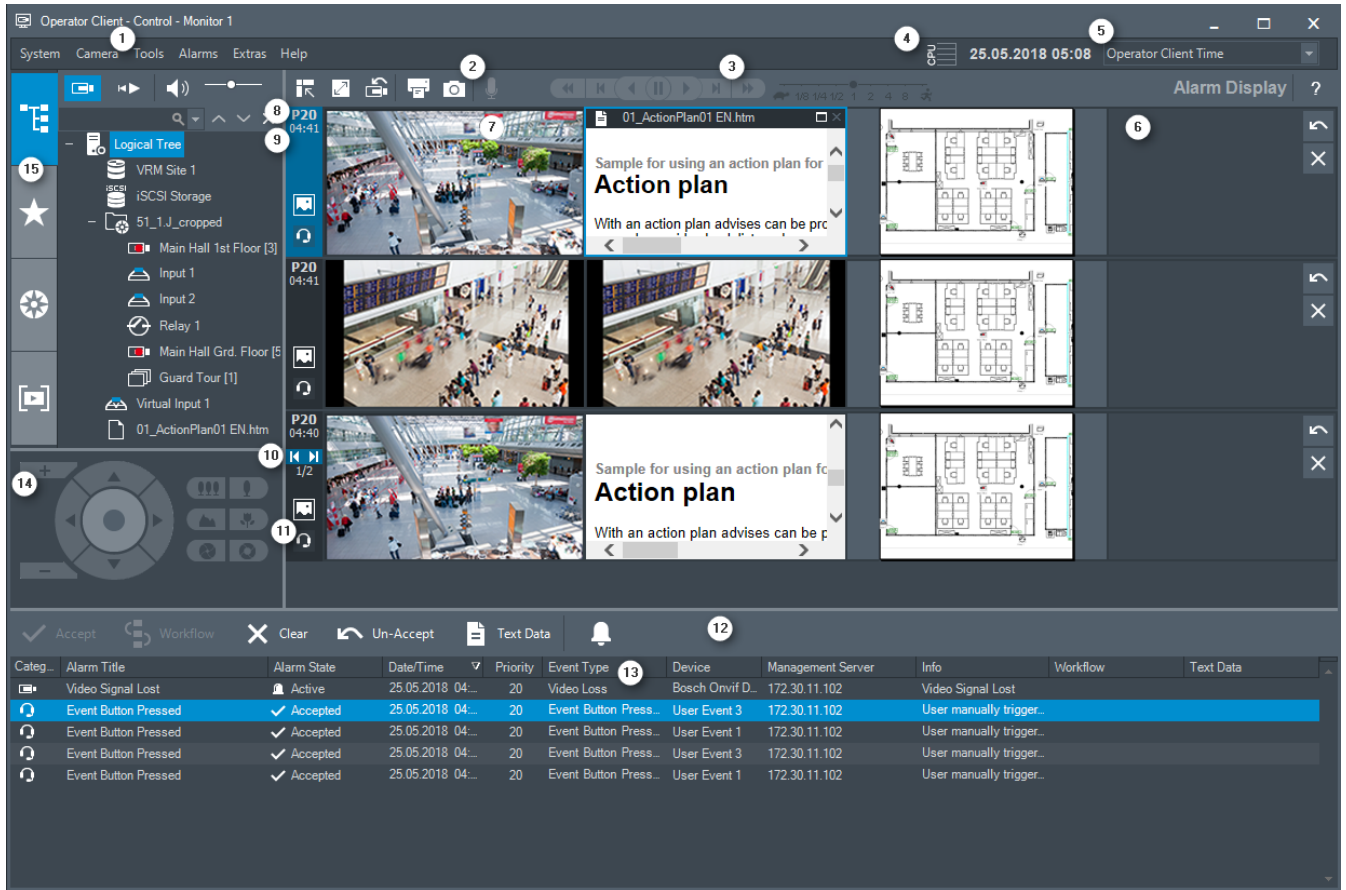



Notice!

A map displayed in an Alarm Image pane is optimized for display and contains only the initial view of the basic .dwf file.



1	Menu bar	Allows you to select a menu command.
2	Toolbar	Displays the available buttons. Point to an icon to display a tooltip.
3	Playback controls	Allows you to control instant playback or a camera sequence or alarm sequence.
4	Performance meter	Displays the CPU usage and the memory usage.
5	Time zone selector	Select an entry for the time zone to be displayed in most time related fields. Only available if at least one Management Server unmanaged site in the Logical Tree is located in another time zone as your Operator Client.
6	Alarm Image window	Displays the Alarm Image panes.
7	Alarm Image pane	Displays a camera, a map, an image, a document (HTML file).
8	Alarm priority	Displays the priority value that was configured in the Configuration Client for the automatic display behavior.
9	Time	Displays the time when the alarm was triggered.
10	Alarm Sequence buttons	Click to display the previous or next Alarm Image pane.

11	Number of alarms	Displays the number of the currently displayed alarm and the number of all alarms.
12	 Alarm List window	Displays all alarms the system generates. Allows you to accept or clear an alarm or to start a workflow, for example, by sending an E-mail to a maintenance person. The Alarm List is not being displayed, when the connection to the Management Server is lost.
13	Event Type	Indicates the type of event that triggered the alarm.
14	 Monitors window (only available if at least one monitor group has been configured)	Displays the configured monitor groups. Allows you to switch to the next or previous monitor group if available. Note: The Monitors tab is not visible if your Operator Client is connected to more than one Management Server.
	 PTZ Control window	Allows you to control a PTZ camera.
15	 Logical Tree window	Displays the devices your user group has access to. Allows you to select a device for assigning it to an Image pane.
	 Favorites Tree window	Allows you to organize the devices of the Logical Tree as required.
	 Bookmarks window	Allows to manage bookmarks.
	 Map window	Displays a site map. Allows you to drag the map to display a particular section of the map. If activated, a map is displayed automatically for each camera displayed in an Image pane. In this case, the camera must be configured on a map.
		Switches to Multi-row alarm mode.
		Switches to Single view alarm mode.

See also

- *Menu commands, page 112*
- *Logical Tree window, page 122*
- *Favorites Tree window, page 123*
- *Map window, page 125*
- *PTZ Control window, page 126*
- *Image window, page 126*
- *Image pane, page 127*

– Alarm List window, page 143

15.4 Icons used

The following table lists the icons used in Operator Client. For the icons used in the Timeline see chapter *Timeline window, page 128*.

Some of the following icons are not available in BVMS Archive Player.



: Root node of the Logical Tree (user assigned name of the Logical Tree).



: Operator Client is connected to a Management Server.



: New configuration available. Log off and log on again to accept.



: Management Server has a previous version.



: Account is disabled. Log off and on again and change password.



: Click to close all open Image panes. This icon has the same function as the shortcut for closing all Image panes.



: Indicates a video analytics device.



: Indicates an unmanaged site which is not connected.



: Indicates an unmanaged site in another time zone than the Operator Client computer.



: Indicates an unmanaged site to which a connection is being established.



: Indicates an unmanaged site which is completely connected. This means that all devices of this site are connected.



: Indicates an unmanaged site which is partially connected. This means that not all devices of this site are connected.



: Click to disconnect all connected unmanaged sites. Partially connected sites are not disconnected.



: Indicates a panoramic camera.



: Intrusion panel.



: Area configured in an intrusion panel.

























: Area is armed.















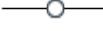



































: Area is disarmed.



: Point configured in an intrusion panel and in the state unbypassed.

-  : Point is in the state bypassed.
-  : Point is in alarm state.
-  : Door configured in an intrusion panel.
-  : Door is secured.
-  : Door is locked.
-  : Door is unlocked.
-  : License not available
-  : Not connected
-  : Primary VRM
-  : Secondary VRM
-  : Primary Failover VRM
-  : Secondary Failover VRM
-  : Indicates the source of the displayed recording: Primary VRM recording. On the Image pane toolbar, click to change the recording source (only available, if Secondary VRM or ANR is configured).
-  : Indicates the source of the displayed recording: Secondary VRM recording. On the Image pane toolbar, click to change the recording source.
-  : Indicates that ANR provides playback. On the Image pane toolbar, click to change the recording source.
-  : Indicates that the Primary Failover VRM provides playback. On the Image pane toolbar, click to change the recording source (only available, if Secondary VRM or ANR is configured).
-  : Indicates that the Secondary Failover VRM provides playback. On the Image pane toolbar, click to change the recording source.
-  : Indicates that the Encoder provides playback. On the Image pane toolbar, click to change the recording source (only available, if Secondary VRM or ANR is configured).
-  : Indicates that the Encoder provides playback. On the Image pane toolbar, click to change the recording source.
-  : Text data available
-  : Text data not available
-  : Unavailable. For a Management Server: No configuration available

-  : Disconnected
-  : Not authorized
-  : Live Mode
-  : Playback Mode
-  : Management Server is located in another time zone.
-  : Slider to adjust audio volume of all Image panes.
-  /  : Audio on / off
-  : Click to display / hide the toolbar of each Image pane.
-  : Click to display the Image pane in full-screen mode.
-  : Click to show fewer Image pane rows.
-  : Click to show more Image pane rows.
-  : Slider to change Image pane rows.
-  : Click to print an image of the selected Image pane.
-  : Click to save an image file of the selected Image pane.
-  : Click to add a Favorites View.
-  : Click to add a bookmark.
-  : Click and hold to speak on the loudspeakers of an encoder with audio configured. The button is active when an encoder with audio function is selected in an Image pane.
-  : Folder containing various items
-  : Folder containing various items and having assigned a map
-  : Camera
-  /  : Connection lost
-  : Recording camera
-  : Video loss
-  : Matrix camera
-  : Camera with local storage

-  : DVR camera
-  : DiBos camera
-  : Recording DiBos camera
-  : State unknown
-  : Too bright
-  : Too dark
-  : Too noisy
-  : Reference check failed (for example because the camera was moved)
-  : Relay
-  : Inputs
-  : Command Script
-  : Document
-  : Camera sequence
-  : Camera sequence is interrupted.
-  : Camera sequence is playing.
-  : Digital zoom
-  : Transcoding enabled
-  : Manual alarm recording
-  : Instant playback
-  : Root node of the Favorites tree
-  : Click to display the Alarm Image window (only available if alarms are pending).
-  : Click to display Live or Playback Mode again when the Alarm Image window is displayed.

See also

– *Timeline window, page 128*

15.5

Menu commands

System menu commands	
	<p>Playback mode / Live mode</p> <p>Switches to Playback or Live Mode depending on the current state.</p>

	Change password...	Displays a dialog box for entering a new password.
	Logoff	Exits the program and displays the dialog box for logging on.
	Exit	Exits the program.
Camera menu commands		
	Save image...	Displays a dialog box for saving an image of the selected camera.
	Print image...	Displays a dialog box for printing an image of the selected camera.
	Audio on / Audio off	Turns audio of the selected camera on or off.
	Record camera	Starts recording of the selected camera. The Alarm recording Mode quality level is used.
	Instant playback	Starts playback of the selected camera for the configured rewind time. (Not in Playback Mode)
	Reference Image...	Displays the Reference Image dialog box for the currently selected Image pane. (Not in Playback Mode)
	Close	Closes the selected Image pane.
Tools menu commands		
	Find in logbook...	Displays the Select Search Parameters and the Logbook results: dialog box. When you logged on as a user of an Enterprise User Group, the Please select a Server dialog box is displayed.
	Find video...	Available only in Playback Mode. Click to display the Select Search Parameters dialog box.
	Toggle image pane bars	Hides or displays the Image pane bars.
	Show fewer image pane rows	Decreases the number of Image pane rows displayed in the Image window.
	Show more image pane rows	Increases the number of Image pane rows displayed in the Image window. Note: You cannot display more Image pane rows than the configured maximum, which is set by a parameter in the BVMS Configuration Client.

Timeline menu commands (Playback Mode only)		
	First recording	Moves the hairline to the oldest recording.
	Last recording	Moves the hairline to the latest recording.
	Play	Plays forward starting from the current position of the hairline.
	Pause	Stops playback at the current position. Click Play to resume.
	Reverse play	Plays backward from the current position of the hairline.
	Protect video...	Displays the Protect Video dialog box.
	Unprotect video...	Displays the Unprotect Video dialog box.
	Restrict video...	Displays the Restrict Video dialog box.
	Unrestrict video...	Displays the Unrestrict Video dialog box.
	Delete video...	Displays the Delete Video dialog box.
	Verify authenticity...	Displays the Verify Authenticity dialog box.
	Export video...	Displays the Export Video dialog box.
	Load exported video...	Displays a dialog box for selecting an export file. The exported file is then displayed in the Exports Tree .
Alarms menu commands		
	Accept Selected Alarms	Sets all selected alarms to the alarm state Accepted and displays them in the Alarm Image window.
	Accept All New Alarms	Sets all new alarms to the alarm state Accepted .
	Clear all accepted alarms	Sets all accepted alarms to the alarm state Cleared . The entry is removed from the Alarm List and from the Alarm Image window.
	Clear Selected Alarms	Sets all selected alarms to the alarm state Cleared . The entry is removed from the Alarm List and from the Alarm Image window.
	Workflow...	Displays the action plan for the selected alarm if available.
Extras menu commands		
	Add favorite	Saves the current Image pane pattern as a View in the Favorites Tree .
	Add bookmark	Displays the Add Bookmark dialog box.

	Mute System	Turns off audio of the available Image panes and the alarm sound.
	Options...	Displays the Options dialog box.
	Restore > Default settings	Restores the settings for monitor layout, user interface and options to the factory default settings. Note: This option considers the configured maximum number of Image pane rows displayed in the Image window. The default number of Image pane rows is restored only if it does not exceed the configured maximum, which is set by a parameter in the BVMS Configuration Client.
	Restore > Last settings	Restores the settings for monitor layout, user interface and options to the last loaded settings. Note: This option considers the configured maximum number of Image pane rows displayed in the Image window. The last loaded number of Image pane rows is restored only if it does not exceed the configured maximum, which is set by a parameter in the BVMS Configuration Client.
Help menu commands		
	Display help	Displays the BVMS Online Help.
	About...	Displays a dialog box containing information on the installed system, for example the version number.

15.6 Reference Image dialog box

Main window >  > Right-click an Image pane > **Reference Image...** command
Allows you to display and update the Reference image.

Camera view:

Displays the live view of the selected camera.

Reference image:

Displays the reference image after clicking **Update**.

Update

Click to set the reference image. The image of the time when you click **Update** is used.

See also

- *Updating the reference image, page 52*

15.7 Please select a Server

Main window > **Tools** menu > **Find in logbook...** command

This dialog box only appears when you logged on as user of an Enterprise User Group.

Allows you to select a Management Server where the Logbook search is performed.

Management Server:

Select the IP address of the desired Management Server.

15.8 Select Search Parameters dialog box

Main window > **Tools** menu > **Find in logbook...** command > **Please select a Server** dialog box (if required)

or

Main window >  >  > **Please select a Server** dialog box (if required)

Allows you to define and save search criteria for finding entries in the Logbook. If you start this dialog box from within the Playback Mode via **Tools** menu, the time period selected in the **Timeline** window is copied into the **Date and Time** fields.

If you start this dialog box via , the search for text data is not supported. If you start via the **Find in logbook...** command, text search is supported.

If you start this dialog box via , the cameras of the current Image window are preselected for the search and the Management Server of the camera displayed in the selected Image pane is preselected. If no camera is displayed in the Image window, the first Management Server of the Logical Tree is preselected.

If you select another time zone, the date and time display of the Logbook search results is changed accordingly.

Filter

Select a filter name with predefined search criteria or type a name for a new filter.

Delete

Click to remove the entry selected in the **Filter** list.

Load

Click to load the search criteria of the selected filter name.

Save

Click to save the search criteria with the selected filter name.

Reset

Click to clear all search criteria of the selected filter name.

Date and Time

Type the date and time to define the period you want to search.

Result Count

Select an entry in the list to limit the number of matches that result from the search.

Add

Click to display the **Event Selection** dialog box.

Remove

Click to remove a selected event entry.

Remove All

Click to remove all event entries.

Add/Edit

Click to display the **Search Conditions** dialog box.

Remove

Click to remove the selected condition entry.

Remove All

Click to remove all condition entries.

Alarm priority

Select an alarm priority to search for.

Alarm State

Select an alarm state to search for.

Record only

Click to select for searching record-only alarms.

Force workflow

Click to select for searching force workflow alarms.

Auto clear

Click to select for searching auto-clear alarms.

Add

Click to display the **Device Selection** dialog box.

Remove

Click to remove a selected device entry.

Remove All

Click to remove all device entries.

Details

Type a string to search for. Some important events contain strings to better find them. For example, a particular SystemErrorEvent has the string **Server alarm queue capacity reached!**. You can use * as a wildcard. For example, enter *triggered* to find the string An alarm was triggered by a network failure.*triggered or triggered* will not find this string.

User name

Type a user name to search for.

Search

Click to start the search. The **Logbook results:** dialog box is displayed.

Close

Click to close the dialog box. No search is executed. If you did not save your search criteria with a filter name, they get lost.

See also

– *Finding recorded video, page 77*

- *Finding logbook entries, page 76*
- *Search Conditions dialog box, page 119*
- *Device Selection dialog box, page 119*
- *Event Selection dialog box, page 120*

15.9 Search for Text Data dialog box

Main window >  >  >  > Click  > **Please select a Server** dialog box (if required) > **Search for Text Data** dialog box

You can find text data in recordings. You can refine your search by adding specific text data with a specific value.

Entries in the **Date and Time** fields, the **Data Field Name** field, and the **Comparative Value** field are retained after the next restart or re-logout of Operator Client.

Sources

In the list, click to select the desired cameras for searching.

Date and Time

Type the date and time to define the period you want to search.

Search Conditions

Add a search condition to refine your search.

See also

- *Text data, page 24*
- *Displaying text data, page 78*

15.10 Search Conditions dialog box

Main window > **Tools** menu > **Find in logbook...** command > **Select Search Parameters** dialog box > **Add/Edit** button

You can combine multiple values of different text data entries to find the desired Logbook entry. For example, you combine a bank routing code with a date to find the respective Logbook entries.

Add Condition

Click to add a new entry in the **Data Field Name** column.

In the list of available data values, select the desired entry.

In the **Comparative Value** column, type in a search string.

Repeat these steps for further data values.

Remove Condition

Click to remove the selected entry.

Remove All

Click to remove all entries.

See also

- *Select Search Parameters dialog box, page 116*
- *Finding logbook entries, page 76*

15.11 Device Selection dialog box

Main window > **Tools** menu > **Find in logbook...** command > **Select Search Parameters** dialog box > **Add** button

Allows you to select the appropriate devices for finding Logbook entries and recorded videos.

See also

- *Finding recorded video, page 77*
- *Finding logbook entries, page 76*
- *Select Search Parameters dialog box, page 116*

15.12 Event Selection dialog box

Main window > **Tools** menu > **Find in logbook...** command > **Select Search Parameters** dialog box > **Add** button

Allows you to add events for filtering purposes.

See also

- *Finding recorded video, page 77*
- *Finding logbook entries, page 76*
- *Select Search Parameters dialog box, page 116*

15.13 Logbook Results: dialog box

Main window > **Tools** menu > **Find in logbook...** command > **Select Search Parameters** dialog box > **Search** button

Displays the results of a Logbook search. If you select another time zone, the date and time display of the Logbook search results is changed accordingly.

Back to filter

Click to display the **Select Search Parameters** dialog box.

Save results

Click to display a dialog box for saving a text file with Logbook entries as CSV file.

**Notice!**

When you open such an exported CSV file in Microsoft Excel, it can happen that time related cells do not display seconds.

To change this behavior, change the formatting of these cells from m/d/yyyy h:mm to m/d/yyyy h:mm:ss

See also

- *Finding logbook entries, page 76*

15.14 Options dialog box

Main window > **Extras** menu > **Options...** command

Allows you to configure parameters for using Operator Client.

See also

- *Displaying video via low bandwidth, page 79*

15.14.1 Control tab

Control tab**Dwell time for automatic sequences [s]**

Enter the required number of seconds a camera is to be displayed in an Image pane. This time is also valid for alarm sequences.

PTZ Control Speed

Move the slider to adjust the control speed for PTZ cameras.

Rewind time of instant playback [s]

Enter the amount of seconds for the rewind time of instant playback.

Display the map containing the camera of the selected Image pane

Click to activate that the map of the camera in the selected Image pane is getting the focus.

The map is displayed in the **Map** window of the **Control** monitor. If the selected camera is not configured on any map, the **Map** window is cleared.

The displayed map is the first found map in the Logical Tree beginning from the root item, that contains the selected camera.

If a camera sequence is running within the selected Image pane, after each sequence step the map in the **Map** window is updated accordingly.

Start PTZ mode when selecting PTZ Image pane with mouse

Select to automatically active PTZ mode for Bosch IntuiKey keyboards for the following cases:

- When the user clicks on an Image pane displaying a PTZ camera.
- When the user drags a PTZ camera to an Image pane.

15.14.2**Display tab****Display tab****Image Pane Aspect Ratio**

For each connected monitor select the required aspect ratio for the Image panes in Operator Client. Use 16:9 for HD cameras. This setting overrides the setting that was made in Configuration Client for the initial startup of Operator Client.

Display Logical Number

Select to display the logical number of a camera in the Logical Tree.

IP address visible in print and save

Select to make the IP addresses of devices in the Logical Tree available in printed or saved images.

Text Data Position

Select the desired option for the location of the text data pane when clicking on .

Prefer hardware acceleration

After logon to Operator Client hardware acceleration is enabled by default.

To disable hardware acceleration, clear the check box.

This setting is retained after the next restart or re-logon of Operator Client.

Show diagnostic information in Image panes (enable until logoff)

Select to show decoding method in the Image pane.

The decoding method is displayed in the title bar of all open Image panes.

This setting is not persistent after the next restart or re-logon of Operator Client.

15.14.3**Audio tab****Audio tab****Playback audio of the selected Image pane**

Select to activate audio playback for the video in the selected Image pane.

Multichannel audio playback

Select to enable simultaneous audio playback for all videos displayed in the Image panes.

Sound volume:

Move the slider to adjust the sound volume of alarm sounds.

Half Duplex

Select to enable half duplex mode for the Intercom functionality.

Full Duplex

Select to enable full duplex mode for the Intercom functionality.

15.14.4**Transcoding tab****Transcoding tab**

You can play back the recordings of a camera or view live images of a camera with Operator Client even if you have a low bandwidth network connection between BVMS and your Operator Client computer.

Transcoders do not support intelligent tracking, ROI, Intelligent Video Analytics overlays, and text data.

For using low bandwidth networks, 2 options are available:

- Hardware transcoding
- Software transcoding (only available for Live Mode)

Hardware transcoding

For hardware transcoding the VRM must be equipped with at least one transcoding device. This transcoding device is not configured in BVMS. See the VRM documentation on how to configure a transcoding device. Transcoding devices can have multiple transcoding instances. DIVAR IP 3000 and DIVAR IP 7000 are delivered each with one preconfigured transcoding instance.

Each live stream or recording needs an own transcoding instance.

Hardware transcoding is possible only for Video IP devices from Bosch connected to a VRM. Both camera and transcoding device must be managed by the same VRM.

Software transcoding

For software transcoding you need a Mobile Video Service configured on your Management Server or your Enterprise Management Server.

In an Enterprise System only the MVS services are used that are configured in the Enterprise Management Server configuration.

Hardware (default)

Select to enable the hardware transcoder. This is the default setting.

Software

Select to enable the software transcoder.

15.15**Logical Tree window**

Main window >  >  tab
or

Main window >  >  tab

Displays the hierarchical structure of all the devices your user group has access to.

If you logged on to an Enterprise Management Server, the server name is displayed as a prefix to the camera name.

Only an administrator can create or change the Logical Tree in the Configuration Client.

Allows you to drag an item to the following elements of the user interface:

- Camera, map, document to an Image pane
- Each item to the **Favorites Tree** window

- Map to **Map** window
- Camera to the **Monitors** window

See also

- *Arranging and resizing Image panes, page 43*
- *Displaying a camera in an Image pane, page 40*
- *Adding items to the Favorites Tree, page 61*
- *Starting a pre-configured camera sequence, page 45*
- *Displaying video via low bandwidth, page 79*

15.16 Favorites Tree window

Main window >  >  tab
or

Main window >  >  tab

You can add every item of the Logical Tree to a view in the Favorites Tree to create your own subset of the Logical Tree. At any time you can display the view or add or delete devices in a view.



When saving a view in the Favorites Tree, you save the following settings:

- The assignment of cameras or other objects to Image panes
- The Image pane pattern
- The current setting of the digital zoom
- The image section
- The selected stream (only available for Live Mode)

See also

- *Adding items to the Favorites Tree, page 61*
- *Creating/editing views, page 62*

15.17 Bookmarks window

Main window >  >  tab
or

Main window >  >  tab

You can save a time period of live view or a recording in a bookmark. A bookmark saves a start and an end time, the cameras assigned to Image window at this time, and the entire Image

pane pattern. A time period of 0 seconds is possible. Bookmarks are saved in the  pane. Deleting a bookmark does not affect the corresponding recordings. You cannot add or remove cameras from a bookmark. To change a bookmark, load it, make your changes and save it. If a recording is deleted, the corresponding bookmark is not synchronized. If loaded, a black Image pane is displayed.



If you have logged on to an Enterprise Management Server, the camera name is displayed with the name of this camera's Management Server as a prefix.

Note: Do not add more than 4 cameras in one bookmark to avoid performance issues when loading the bookmark.



See also

- *Editing a bookmark, page 64*
- *Loading a bookmark, page 64*

15.18 Add Bookmark dialog box

Main window >  > Assign desired cameras to the Image window > 

or

Main window >  > Assign desired cameras to the Image window > 

You can save a time period of live view or a recording in a bookmark. A bookmark saves a start and an end time, the cameras assigned to Image window at this time, and the entire Image

pane pattern. A time period of 0 seconds is possible. Bookmarks are saved in the  pane. Deleting a bookmark does not affect the corresponding recordings. You cannot add or remove cameras from a bookmark. To change a bookmark, load it, make your changes and save it. If a recording is deleted, the corresponding bookmark is not synchronized. If loaded, a black Image pane is displayed.

If you have logged on to an Enterprise Management Server, the camera name is displayed with the name of this camera's Management Server as a prefix.

Note: Do not add more than 4 cameras in one bookmark to avoid performance issues when loading the bookmark.

Start Time

In the lists, select date and time.

End Time

In the lists, select date and time.

Sources

Displays the cameras that belong to this bookmark.

See also

- *Adding a bookmark, page 63*

15.19 Search box



You can use the search box to search for an item in the Logical Tree, in the Favorites Tree and in the Bookmarks.

1. Main window >  >  or  or  tab > Right-click the desired root node or the desired item > Click **Tree search** Or:

In the Logical Tree window, the Favorites Tree window or the Bookmarks window press Ctrl+F.

The search box is displayed 

2. Type a search string representing the display name of an item.
The search is triggered immediately during typing and the first item that matches the search string is marked.
If the search string is not found, the background color of the search box changes.

3. Click  or  to mark the previous or the next matching item.
The search proceeds through all items in the tree that match the search string and not only through the items in the selected tree node.
4. Click  to close the search box.

15.20 Exports window



Main window >  >  tab



You can import exported video data, display it in an Image pane, search for particular data in it, and unload it again.

See also

- *Exporting video data, page 70*
- *Loading exported video, page 73*

15.21 Map window

Main window >  > Drag a map from the  to the  tab
or

Main window >  > Drag a map from the  to the  tab

Displays a site map, it cannot display video content and is not limited to a 4:3 ratio.

If a map cannot be displayed completely in the **Map** window, you can drag the map. A special cursor is displayed.

Click to get step-by-step instructions:

- *Displaying a map, page 58*

15.22 Monitor Wall Image window

Main window >  > Drag the monitor wall from the Logical Tree to an Image pane > Drag cameras to the monitor wall Image window

Select layout:

Select the desired entry for the layout of the monitor wall. Only n x m layouts are supported. If thumbnails have been configured, in each Image pane you see a static image that is updated regularly.

An Image pane that is connected to a camera displays the name of the camera, IP address and encoder input number, server number and the camera number in a tooltip.

A brown frame around a camera Image pane indicates a static camera image.

A green frame around a camera Image pane indicates a sequence running in this Image pane.

An empty Image pane is displayed with blue color.

Status information on the connection to the monitor wall hardware is displayed in the status line in the lower boundary of the monitor wall Image window.

A connection loss between monitor wall and a camera is displayed with  .

See also

- *Controlling a monitor wall, page 53*

15.23 PTZ Control window



The  window becomes active when a PTZ camera or a swiveling/tilting camera is displayed in the selected Image pane.

Allows you to control a camera with the corresponding functions displayed in the selected Image pane.



Click to zoom in or out digitally. These controls are active even when a non-PTZ camera is selected.



Click an arrow or drag the joystick in the center to swivel the camera in all directions.



Click to zoom in the picture angle (zoom angle) / zooming out the picture angle (wide angle).



Click to set the focus near / focus far.



Click to close the iris / open the iris.

Prepositions:

Select an entry to move the PTZ control to the predefined position.



Click to save the current position of the PTZ camera to the selected preposition entry.

AUX Commands:

Select an entry to execute this command.

15.24 Image window

Main window

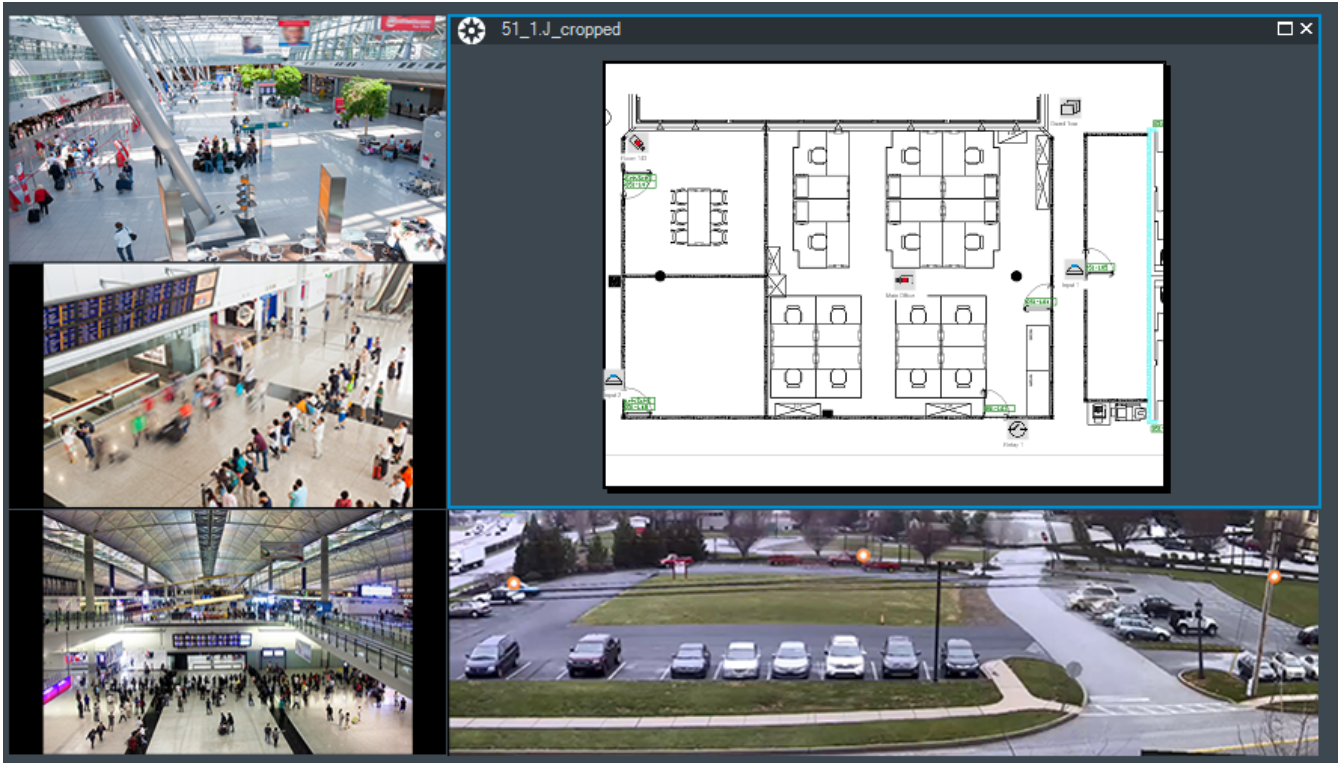

Displays a variable number of Image panes. Minimum is 1 Image pane. You can display one camera in several Image panes simultaneously.

Allows you to perform the following tasks (not all tasks are available in BVMS Archive Player):

- Changing the number of displayed Image panes.
- Arranging the Image panes with high flexibility, changing the pattern of the Image panes, and saving this arrangement as a View in the **Favorites Tree**.
- Toggling between Live Mode and Playback Mode (and Alarm Mode if alarms are available).
- Switching on/off all audio sources (application must be configured for multi-channel mode).
- Starting a sequence.
- Switching on/off the Image pane toolbars.
- Performing instant playback.
- Using Intercom functionality.

See also

- *Changing the number of Image pane rows, page 42*
- *Arranging and resizing Image panes, page 43*

15.25 Image pane

Main window

BVMS Archive Player offers only a restricted feature set.

Allows you to display:

- Live video from any video source (Live Mode only)
- Instant playback video
- Recorded video (Playback Mode only)
- Maps
- Documents (HTML files)

- Text data
- Recording source

A blue border indicates that this Image pane is selected, for example, for displaying a camera image in this Image pane.

Note: The toolbar of an image pane is only displayed, if the image pane is selected.

If you log on to an Enterprise Management Server, the camera name with the name of this camera's Management Server as a prefix is displayed in the image pane toolbar, if the image pane is selected.

Cameras in the map are displayed as hot spots. You can activate a camera in the map by double-clicking, context menu, or dragging and dropping to an Image pane.

When a PTZ camera is displayed, you can use in-window control function.

Double-click a camera in the Logical Tree to display it in the next free Image pane.

Right-click in the Image pane and click **Properties** to display the **Properties:** window. This window displays information on the camera.

The time display in the tool bar of a live Image pane always shows the local time of the displayed camera. The time display in the tool bar of a playback Image pane always shows the time of the recorded video.

See also

- *Icons used, page 109*
- *Displaying text data, page 78*

15.26

Timeline window

Main window >  >  tab

Allows you to control the playback of recorded videos. You can display several cameras simultaneously.

Audio playback is only possible when you play the video in normal speed.

If you are authorized to display recorded videos, you can also listen to the accompanying audio recording.

If you select another time zone, the Timeline is changed accordingly.

Allows you to navigate through recorded videos. The playback of all displayed Image panes is synchronized.

Many features enable the precise finding of scenes you are searching for.







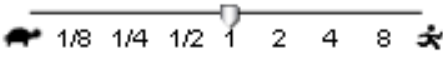

The Timeline for NVR recordings in Operator Client and BVMS Archive Player displays the following information indicated by a color or hatching:

NVR recording	Color
Continuous recording	Dark gray-blue
Alarm recording	Red
Pre-alarm recording	Light red
Motion recording	Yellow
Pre-event recording	Light yellow
Results of motion search	White
No video signal	Black
No recording	Light gray

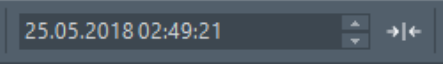
NVR recording	Color
Protected data	Diagonal stripes
Audio data available	Thin green line above the Timeline

The Timeline for VRM recordings in Operator Client and BVMS Archive Player displays the following information indicated by a color or hatching:

VRM recording	Color
Continuous recording	Dark gray-blue
Results of motion search	White
No recording	Light gray
Protected video	White diagonal stripes
Restricted video	Red diagonal stripes

	Click to zoom in or zoom out the Timeline.
	Move the slider to adjust the playback speed for the selected cameras.
	Use the controls to control the playback of the selected cameras. From left to right: <ul style="list-style-type: none"> - Jump to the oldest recording - Single frame backward no matter what frame type - Play backward, you can change the playback speed with the speed slider - Pause play or backward play - Play, you can change the playback speed with the speed slider - Single frame forward no matter what frame type - Jump to the newest recording
	Enter the time for rapid positioning the Hairline in the Timeline.
	Click to move the Hairline to the time in the time field.
	Select the desired recording mode where you want to jump to.
	Click to display the Select Search Parameters dialog box.
	Click to display the Motion Search dialog box.
	Click to display the Export Video dialog box.

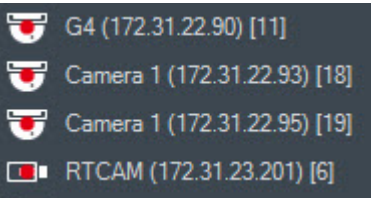
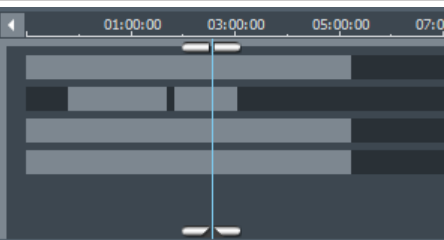
	<p>Displays all cameras displayed in the Image window.</p> <p>If you log on to an Enterprise Management Server, the camera name is displayed with the name of this camera's Management Server as a prefix.</p>
	<p>Displays the Timelines of the cameras in the camera list.</p> <p>Allows you rapid time positioning for playing the corresponding videos.</p>

See also

- *Changing the playback speed, page 68*
- *Using the Timeline, page 67*
- *Finding logbook entries, page 76*
- *Finding motion, page 75*
- *Exporting video data, page 70*
- *Verifying the authenticity of video data, page 70*
- *Protecting video, page 69*
- *Restricting video, page 68*
- *Deleting video data, page 69*
- *Exporting video data, page 70*
- *Loading exported video, page 73*

15.27

Motion Search dialog box

Main window >  >  tab 

Allows you to set up a search filter for motion in designated areas of a camera image. You select the zones where you want to detect motion. You can search for motion only in the selected Image pane.

Start:

Enter date and time for starting the search for motion. Clear the check box if you want the search start at the very beginning of the recording.

End:

Enter date and time for finishing the search for motion. Clear the check box if you want the search stop at the present point in time.

Select All

Click to select the whole image.

Clear Selection

Click to remove the selection.

Invert Selection

Click to invert the selection.

Display Grid

Click to select or clear for displaying a grid for defining the sensitive area where motion search is performed.

Start Search

Click to start the search. The results are displayed in the **Motion Search Results** window.

See also

– *Finding motion, page 75*

15.28 Delete Video dialog box



Main window > **Timeline** tab > Move the Hairline to the desired position > On the **Timeline** menu, click **Delete video...**

Allows you to delete video data from the beginning of the recording to the position of the hairline.



Notice!

You cannot delete the data of a local storage device.

Including

The current selection of the Hairline is displayed. Change the value if required.

See also

– *Deleting video data, page 69*

15.29 Forensic Search dialog box



Main window > **Timeline** tab > Select time period with Hairline > Click **Forensic search** is only available for VRM recordings.

Allows you to find video data with selecting a Forensic Search type, for example Intelligent Video Analytics. You configure the Forensic Search in the **Surveillance Tasks** field. You can search for motion only in the selected Image pane.

Algorithm:

Select the required analysis algorithm. By default, only **MOTION+** is available – this offers a motion detector and essential recognition of tampering. The current alarm status is displayed for information purposes.



Notice!

Additional analysis algorithms with comprehensive functions such as Intelligent Video Analytics are available.

If you select one of these algorithms, you can set the corresponding parameters directly.

Presets:

Select an entry to load Forensic Search settings that you have saved earlier.



Click to save the settings for the Forensic Search. You can enter a descriptive name.

Start:

The current position of the Hairline is displayed.

Enter the point in time when the search starts.

If you uncheck, all recordings until the specified end date are searched.

End:

The current position of the Hairline is displayed.

Enter the point in time when the search ends.

If you uncheck, all recordings beginning with the specified start date are searched.



Click to update the selection in the Timeline with the data of the **Start:** and **End:** fields. Only the selected video is managed.

Surveillance Tasks

Configure your Forensic Search. See the user documentation of the Intelligent Video Analytics version that you are using.

Search

Click to start the Forensic Search.

See also

- *Performing a Forensic Search (only VRM recordings), page 74*



15.30**Restrict Video dialog box**

Main window >  > **Timeline** menu > **Restrict video...** command > **Restrict Video** dialog box

You can restrict the recordings of cameras connected to the following DIVAR devices:

- DIVAR AN 3000
- DIVAR AN 5000
- DIVAR hybrid
- DIVAR network

When restricted, an unauthorized user cannot display the recordings of these cameras.

The DIVAR devices can be connected to BVMS either locally under  or as an unmanaged site under .

For restricting you need the corresponding permission.

Start:

The current selection of the Hairline is displayed.

If you uncheck, all recordings until the specified end date are restricted.

End:

The current selection of the Hairline is displayed.

If you uncheck, all recordings beginning with the specified start date are restricted.

**Notice!**

Unrestricting / unprotecting a selected time period can possibly unrestrict / unprotect the entire contiguous restricted / protected time period of this camera, even outside the selected time period.

Restrict

Click to restrict the selected time period.

See also

- *Restricting video, page 68*

15.31 Unrestrict Video dialog box

Main window >  > **Timeline** menu > **Unrestrict video...** command > **Unrestrict Video** dialog box

You can unrestrict the recordings of cameras connected to the following DIVAR devices:

- DIVAR AN 3000
- DIVAR AN 5000
- DIVAR hybrid
- DIVAR network

The DIVAR devices can be connected to BVMS either locally under  or as an unmanaged

site under .

For unrestricting you need the corresponding permission.

Start:

The current selection of the Hairline is displayed.
If you uncheck, all recordings until the specified end date are unrestricted.

End:

The current selection of the Hairline is displayed.
If you uncheck, all recordings beginning with the specified start date are unrestricted.



Notice!

Unrestricting / unprotecting a selected time period can possibly unrestrict / unprotect the entire contiguous restricted / protected time period of this camera, even outside the selected time period.

Unrestrict

Click to unrestrict the selected time period.

See also

- *Restricting video, page 68*

15.32 Protect Video dialog box

Main window >  > **Timeline** menu > **Protect video...** command > **Protect Video** dialog box

Allows you to protect the selected video data.



Notice!

You cannot protect the data of a local storage device.

Start:

The current selection of the Hairline is displayed.
Enter the point in time when the protection starts.
If you uncheck, all recordings until the specified end date are protected.

End:

The current selection of the Hairline is displayed.
 Enter the point in time when the protection ends.
 If you uncheck, all recordings beginning with the specified start date are protected.

**Notice!**

Unrestricting / unprotecting a selected time period can possibly unrestrict / unprotect the entire contiguous restricted / protected time period of this camera, even outside the selected time period.

Protect

Click to protect the selected time period.

See also

– *Protecting video, page 69*

15.33**Unprotect Video dialog box**

Main window >  > **Timeline** menu > **Unprotect video...** command > **Unprotect Video** dialog box

Allows you to protect the selected video data.

Start:

The current selection of the Hairline is displayed.
 Enter the point in time when the protection starts.
 If you uncheck, all recordings until the specified end date are unprotected.

End:

The current selection of the Hairline is displayed.
 Enter the point in time when the protection ends.
 If you uncheck, all recordings beginning with the specified start date are unprotected.

**Notice!**

Unrestricting / unprotecting a selected time period can possibly unrestrict / unprotect the entire contiguous restricted / protected time period of this camera, even outside the selected time period.

Unprotect

Click to unprotect the selected time period.

See also

– *Protecting video, page 69*

15.34**Delete Video dialog box**

Main window >  > **Timeline** menu > **Delete video...** command > **Delete Video** dialog box

Allows you to delete video data.

**Notice!**

You cannot delete the data of a local storage device.

Start:

The current selection of the Hairline is displayed.
Enter the point in time when the deletion starts.
If you uncheck, all recordings until the specified end date are deleted.

End:

The current selection of the Hairline is displayed.
Enter the point in time when the deletion ends.
If you uncheck, all recordings beginning with the specified start date are deleted.

Delete

Click to delete the selected time period.

See also

– *Deleting video data, page 69*

15.35**Export Video dialog box**

Main window >  > **Timeline** menu > **Export video...** command > **Export Video** dialog box

Allows you to export video data in BVMS Archive Player, ASF or MOV format. You can change the time period for the export. For each camera, a subfolder is created in the target folder. When the verification of authenticity is enabled in Configuration Client, each export is automatically checked.

**Notice!**

You cannot export the data of a local storage device.

Export of a panoramic camera

When you export the recordings of a panoramic camera you always export the full image circle. If you export multiple cropped Image panes of the same panoramic camera, the full image circle of this camera is exported only once. This also applies for the export of non-panoramic cameras.

Unencrypted export

You can export video and audio data to a local drive, a CD/DVD drive, a Blu-Ray disk, a network drive, or a USB drive.

Note: If you use a USB drive, use a fast USB device to avoid failures.

The data is exported in native (BVMS Archive Player), ASF or in MOV format.

When you export a video in native format, you can add BVMS Archive Player as a viewer.

Data in MOV format can be played with standard software such as QuickTime from Apple.

You export the video and audio data of the selected cameras.

Only in an Enterprise System: You can select a remote Management Server to perform the export there. You can only export the recordings of the cameras that are managed by the selected Management Server.

Only one export at a time can run on a workstation.

Note: You need a permission for each camera that you want to export.

If exporting video data on a hard drive was not successful for multiple cameras, the completely exported video data of cameras is retained. The data of an uncomplete export process of a camera is deleted.

If the user cancels the export, the already exported video data of this export process is deleted.

The video export without providing a password creates an unencrypted file with the extension `.info` and the unencrypted video data files in subfolders. The operator must select the `.info` file when loading this unencrypted export.

Encrypted export

When a password is provided for a video export, a file with the extension `.encr` and the encrypted video data files in subfolders are created.

For loading the encrypted export, the operator must select the encrypted `.encr` file and type in the correct password.

The `.encr` file and the encrypted video data files are indicated by a specific file icon.

If a file in the subfolders of an encrypted export is deleted or tampered, you cannot import this encrypted export.

If exporting video data on a hard drive was not successful or the user cancels the export, the already exported video data of this export process is deleted.

Export on multiple discs

Encrypted export and export into a single ZIP file are not possible on multiple CDs/DVDs/Blu-Ray discs. If the export fits on a single CD/DVD/Blu-Ray disc, encrypted export on a CD/DVD/Blu-Ray disc is possible.

Recordings that were selected for export and that are to be exported to CD/DVD/Blu-Ray discs, are first written to the local hard drive and then written to one or more writeable discs. Unencrypted export on multiple discs is only supported for native format. Exporting with ASF or MOV format only works when it fits on one disc.

The first inserted disc determines the media type of all following discs.

If recordings were exported to multiple CD/DVD/Blu-Ray discs, and you must view all exported cameras in all exported time periods, copy the content of all discs to your hard drive. You can ignore all occurring overwrite warnings.

You can view the recordings exported to a single disc out of a group of discs that were created during an export.

If exporting video data on a CD/DVD/Blu-Ray disc was not successful or the user cancels the export, the already exported video data of this export process is retained.

Name

Type the name for the exported file.

Start:

Select the check box to set a start time for exporting. In the lists, select date and time.

End:

Select the check box to set an end time for exporting. In the lists, select date and time.

Native format

Click to select the BVMS Archive Player format.

If you want to encrypt the export, click to activate **Encrypt Export**. Type in a password and confirm it.

Export file viewer

Click to select that a setup for BVMS Archive Player is stored in the location selected under **Data Medium**.

ASF (Compatible with Media Player)

Click to select the ASF format. In the list, select an entry for the quality.

MOV (Fast and compatible with Media Player)

Click to select the MOV format (compatible for example with QuickTime from Apple).

Encrypt Export

Click to select encryption for this export.

Password

Type in a password for your encrypted export. Confirm this password in the **Confirm password** field.

Export as single ZIP file

Select to store the exported files in a single ZIP file. You use the ZIP file format to store all exported files in a single file, compression of the data is not available.

On a FAT32 partition, the maximum file size of the ZIP file is 4 GB.

Remote Export

Click to enable remote export. You can select a Management Server of your Enterprise System. On this Management Server the export is performed.

Ensure that the desired storage media is available.

Disk

Click **Browse** to select a hard disk partition for exporting.

CD/DVD/Blu-Ray

In the list, select a CD/DVD/Blu-Ray writer for exporting.

Not active when the **Remote Export** option is selected.

Finalize Disk

Click to select that the data medium is finalized after the successful burning process. After finalizing no further data can be burned on the data medium.

Comment:

Enter a comment for the export.

Cancel

Click to save the dialog settings until you start Operator Client the next time.

See also

- *Exporting video data, page 70*
- *Providing a password for export, page 72*
- *Exporting into a single file, page 73*

15.36**Export Bookmark dialog box**

Main window >  > Right-click a bookmark > **Export bookmark** command > **Export bookmark** dialog box

Allows you to export video data of a bookmark in BVMS Archive Player, ASF or MOV format.

You can change the time period for the export. For each camera, a subfolder is created in the target folder.

Export of a panoramic camera

When you export the recordings of a panoramic camera you always export the full image circle. If you export multiple cropped Image panes of the same panoramic camera, the full image circle of this camera is exported only once. This also applies for the export of non-panoramic cameras.

Unencrypted export

You can export video and audio data to a local drive, a CD/DVD drive, a Blu-Ray disk, a network drive, or a USB drive.

Note: If you use a USB drive, use a fast USB device to avoid failures.

The data is exported in native (BVMS Archive Player), ASF or in MOV format.

When you export a video in native format, you can add BVMS Archive Player as a viewer. Data in MOV format can be played with standard software such as QuickTime from Apple. You export the video and audio data of the selected cameras.

Only in an Enterprise System: You can select a remote Management Server to perform the export there. You can only export the recordings of the cameras that are managed by the selected Management Server.

Only one export at a time can run on a workstation.

Note: You need a permission for each camera that you want to export.

If exporting video data on a hard drive was not successful for multiple cameras, the completely exported video data of cameras is retained. The data of an uncomplete export process of a camera is deleted.

If the user cancels the export, the already exported video data of this export process is deleted.

The video export without providing a password creates an unencrypted file with the extension `.info` and the unencrypted video data files in subfolders. The operator must select the `.info` file when loading this unencrypted export.

Export on multiple discs

Encrypted export and export into a single ZIP file are not possible on multiple CDs/DVDs/Blu-Ray discs. If the export fits on a single CD/DVD/Blu-Ray disc, encrypted export on a CD/DVD/Blu-Ray disc is possible.

Recordings that were selected for export and that are to be exported to CD/DVD/Blu-Ray discs, are first written to the local hard drive and then written to one or more writeable discs. Unencrypted export on multiple discs is only supported for native format. Exporting with ASF or MOV format only works when it fits on one disc.

The first inserted disc determines the media type of all following discs.

If recordings were exported to multiple CD/DVD/Blu-Ray discs, and you must view all exported cameras in all exported time periods, copy the content of all discs to your hard drive. You can ignore all occurring overwrite warnings.

You can view the recordings exported to a single disc out of a group of discs that were created during an export.

If exporting video data on a CD/DVD/Blu-Ray disc was not successful or the user cancels the export, the already exported video data of this export process is retained.

Name

Type the name for the exported file.

Start:

Select the check box to set a start time for exporting. In the lists, select date and time.

End:

Select the check box to set an end time for exporting. In the lists, select date and time.

Native format

Click to select the BVMS Archive Player format.

If you want to encrypt the export, click to activate **Encrypt Export**. Type in a password and confirm it.

Export file viewer

Click to select that a setup for BVMS Archive Player is stored in the location selected under **Data Medium**.

ASF (Compatible with Media Player)

Click to select the ASF format. In the list, select an entry for the quality.

MOV (Fast and compatible with Media Player)

Click to select the MOV format (compatible for example with QuickTime from Apple).

Encrypt Export

Click to select encryption for this export.

Password

Type in a password for your encrypted export. Confirm this password in the **Confirm password** field.

Remote Export

Click to enable remote export. You can select a Management Server of your Enterprise System. On this Management Server the export is performed. Ensure that the desired storage media is available.

Disk

Click **Browse** to select a hard disk partition for exporting.

CD/DVD/Blu-Ray

In the list, select a CD/DVD/Blu-Ray writer for exporting. Not active when the **Remote Export** option is selected.

Finalize Disk

Click to select that the data medium is finalized after the successful burning process. After finalizing no further data can be burned on the data medium.

Comment:

Enter a comment for the export.

See also

- *Exporting bookmarks, page 64*
- *Providing a password for export, page 72*

15.37

Export Multiple Bookmarks dialog box

Main window >  tab > Right-click a bookmark > **Export multiple bookmarks** command > **Export Video** dialog box

Allows you to export video data of multiple bookmarks in BVMS Archive Player, ASF or MOV format. This way you can export different time periods of the same or different cameras in one process. For each camera, a subfolder is created in the target folder.

Export of a panoramic camera

When you export the recordings of a panoramic camera you always export the full image circle. If you export multiple cropped Image panes of the same panoramic camera, the full image circle of this camera is exported only once. This also applies for the export of non-panoramic cameras.

Unencrypted export

You can export video and audio data to a local drive, a CD/DVD drive, a Blu-Ray disk, a network drive, or a USB drive.

Note: If you use a USB drive, use a fast USB device to avoid failures.

The data is exported in native (BVMS Archive Player), ASF or in MOV format.

When you export a video in native format, you can add BVMS Archive Player as a viewer. Data in MOV format can be played with standard software such as QuickTime from Apple. You export the video and audio data of the selected cameras.

Only in an Enterprise System: You can select a remote Management Server to perform the export there. You can only export the recordings of the cameras that are managed by the selected Management Server.

Only one export at a time can run on a workstation.

Note: You need a permission for each camera that you want to export.

If exporting video data on a hard drive was not successful for multiple cameras, the completely exported video data of cameras is retained. The data of an uncomplete export process of a camera is deleted.

If the user cancels the export, the already exported video data of this export process is deleted.

The video export without providing a password creates an unencrypted file with the extension `.info` and the unencrypted video data files in subfolders. The operator must select the `.info` file when loading this unencrypted export.

Export on multiple discs

Encrypted export and export into a single ZIP file are not possible on multiple CDs/DVDs/Blu-Ray discs. If the export fits on a single CD/DVD/Blu-Ray disc, encrypted export on a CD/DVD/Blu-Ray disc is possible.

Recordings that were selected for export and that are to be exported to CD/DVD/Blu-Ray discs, are first written to the local hard drive and then written to one or more writeable discs. Unencrypted export on multiple discs is only supported for native format. Exporting with ASF or MOV format only works when it fits on one disc.

The first inserted disc determines the media type of all following discs.

If recordings were exported to multiple CD/DVD/Blu-Ray discs, and you must view all exported cameras in all exported time periods, copy the content of all discs to your hard drive. You can ignore all occurring overwrite warnings.

You can view the recordings exported to a single disc out of a group of discs that were created during an export.

If exporting video data on a CD/DVD/Blu-Ray disc was not successful or the user cancels the export, the already exported video data of this export process is retained.

Name

Type the name for the exported file.

Native format

Click to select the BVMS Archive Player format.

If you want to encrypt the export, click to activate **Encrypt Export**. Type in a password and confirm it.

Include Viewer

Click to select that a setup for BVMS Archive Player is stored in the location selected under **Target**.

ASF (Compatible with Media Player)

Click to select the ASF format. In the list, select an entry for the quality.

MOV (Fast and compatible with Media Player)

Click to select the MOV format (compatible for example with QuickTime from Apple).

Encrypt Export

Click to select encryption for this export.

Password

Type in a password for your encrypted export. Confirm this password in the **Confirm password** field.

HDD

Click to select a folder on a hard disk partition for exporting.

CD/DVD/Blu-Ray

In the list, select a writer device for exporting.

Enable **Finalize Disk**, if you do not want to burn further data on the data medium.

Bookmarks

In the list, select the bookmarks that you want to export.

Finalize Disk

Click to select that the data medium is finalized after the successful burning process. After finalizing no further data can be burned on the data medium.

Comment:

Enter a comment for the export.

See also

- *Exporting bookmarks, page 64*
- *Providing a password for export, page 72*

15.38**Export dialog box**

Main window >  > **Timeline** menu > **Export video...** command > **Export Video** dialog box > **Export** button > **Export** dialog box
or

Main window >  tab > Right-click a bookmark > **Export multiple bookmarks** command > **Export Video** dialog box > **Export** button > **Export** dialog box
or

Main window >  > Right-click a bookmark > **Export bookmark** command > **Export Video** dialog box > **Export** button > **Export** dialog box

Allows you to view information on the performed export and to display the results of the authenticity verification that is automatically performed on every export.

Verification Details

Click to display the **Authenticity Verification Result** dialog box.

This button is only available if authentication issues were found.

See also

- *Exporting video data, page 70*
- *Exporting into a single file, page 73*

15.39**Authenticity Verification Result dialog box**

Main window >  > **Timeline** menu > **Verify authenticity...** command > **Verify Authenticity** dialog box > **Verify** button > **Authenticity Verification Result** dialog box
or

Main window >  > **Timeline** menu > **Export video...** command > **Export Video** dialog box > **Verification Details** button > **Authenticity Verification Result** dialog box
or
or

Main window >  > Right-click a bookmark > **Export bookmark** command > **Export bookmark** dialog box > **Verification Details** button > **Authenticity Verification Result** dialog box
or

Main window >  tab > Right-click a bookmark > **Export multiple bookmarks** command > **Export Video** dialog box > **Verification Details** button > **Authenticity Verification Result** dialog box

Allows you to view the results of an authenticity verification of a selected time period of recorded video. You can save the results in a CSV file.

Created on

Displays the date when the authenticity verification was performed.

By

Displays the name of the user who started the authenticity verification.

Time range

Displays the time period to be verified that was selected by the user.

Summary

Displays the number of cameras which recordings have been verified, and the results.

Details

Click to display detailed information on the authenticity verification.

Authentic

Displays an authentic result. The icon is explained in the summary.

Camera

Displays the camera that was verified.

Date / Time

Displays the authentic time period.

More Information

Displays detailed information on the certificate.

CSV Export

Displays a dialog box to enter path and filename for the authenticity verification report.

See also

- *Exporting video data, page 70*
- *Verifying the authenticity of video data, page 70*
- *Verification of authenticity, page 34*

15.40

Motion Search Results window

Main window >  >  tab

Displays entries for video data containing motion for the camera displayed in the selected Image pane. You can select an entry for playback, protection, authenticity checking, archiving, or export.

Displays the recordings that match the search criteria.

See also

- *Performing a Forensic Search (only VRM recordings), page 74*
- *Exporting video data, page 70*
- *Finding motion, page 75*

15.41 Video Search Results window



Displays entries for video data matching different search criteria. You can select an entry for playback, protection, authenticity checking, archiving, or export.

Allows you to play the recordings that match the search criteria.

15.42 Alarm List window



Click to accept an alarm.

The alarm is removed from all Alarm Lists and alarm video displays of the other operators.



Click to display a dialog box displaying an action plan. If configured, you can enter a comment.



Click to clear an alarm.

You cannot clear an alarm that has the comment or force workflow attribute before you have displayed the action plan and entered a comment. If the alarm is configured as an auto-clear alarm, the alarm is removed from the Alarm List after the auto-clear time (configured in the Configuration Client).



Click to revoke the acceptance of an alarm.



Click to turn alarm audio on / off.

The latest incoming alarm triggers an alarm sound.



Click to display the Alarm List.

See also

- *Alarm handling, page 20*

16 Keyboard shortcuts

This section lists the available keyboard shortcuts for a US keyboard layout.

+ indicates that each key must be pressed simultaneously (for example, Control+z means to press the Control key and the z key simultaneously).

On your Setup CD you find an Acrobat file for printing. The name of this file is keyboard_layout_en.pdf.

16.1 General controls

To	Press
Display Online Help	F1
Rename (for example in favorites)	F2

16.2 Playback controls

To	Press
Play / Pause	Space
Previous frame	,
Next frame	.
Set direction to forward	Enter
Set direction to backward	Backspace
Jump to oldest recording	Home
Jump to latest recording	End
Increase playback speed	Page Up
Decrease playback speed	Page Down

16.3 Image window controls

The following keyboard shortcuts only work when the Image window has the focus.

To	Press
Move selected Image pane	Cursor keys
Close Image pane	Delete,
Close all Image panes	Control + Delete
Show fewer Image pane rows	F7
Show more Image pane rows	F8*
Show / hide Image pane bars	F9
<p>*Note: You cannot display more Image pane rows than the configured maximum, which is set by a parameter in the BVMS Configuration Client.</p>	

17 Troubleshooting

This chapter contains information on how to handle known problems using BVMS Operator Client BVMS Archive Player.

Problems with playing recorded videos

Caution!

Do not attempt to play recorded videos exported with BVMS V.1.1 with Archive Player from BVMS V.1.0. This can result in data loss.

Issue	Cause	Solution
Archive Player cannot play recorded videos.	Archive Player is from BVMS V.1.0. Recorded video data has been exported with BVMS V.1.1.	Update Archive Player to BVMS V.1.1. See <i>Updating an old BVMS Archive Player version</i> , page 145.

Problems with the settings in the recording control of your soundcard

Issue	Cause	Solution
Feedbacks occur when using a microphone for Intercom functionality.	In the recording control of your soundcard the microphone must be selected, not the stereo mix (or something else). Operator Client checks its configuration file during startup and changes the settings in the recording control accordingly. This configuration file contains a default entry which might not match your system configuration. This setting is restored during each start of Operator Client.	Change the setting in the configuration file of Operator Client to microphone.

Crashing Operator Client

Issue	Cause	Solution
Operator Client crashes.	DiBos Web client is installed and has been started on the computer where Operator Client is installed.	Uninstall the DiBos Web client.

17.1 Updating an old BVMS Archive Player version

To update:

- ▶ Export video data (see *Exporting video data*, page 70).
In the **Export Video** dialog box, select **Export file viewer** and **Native format**.
A setup for installing BVMS Archive Player is stored in the selected location.

17.2

Reestablishing the connection to a Bosch IntuiKey keyboard

1. Plug in the cable again or wait until the workstation is online.
The Off Line message disappears.
2. Press the Terminal softkey to enter BVMS.

Glossary

Alarm Image window

Image window for displaying one or more Alarm Image panes.

Alarm List

Window in Bosch Video Management System used to display a list of active alarms.

alarm priority

Each alarm is assigned a priority. Alarms can be configured to automatically display (pop up) in the Alarm Image window, based on the alarm priority. Each user's live/playback display is also assigned a priority. When alarms are received with priority higher than that of the user's display, the alarm automatically displays its alarm row in the Alarm Image window. If the Alarm Image window is not currently displayed, it automatically replaces the Live or Playback Image window on the alarm-enabled monitor.

analytics viewer

External application that is used for displaying video analytics alarms in Operator Client.

ANR

Automated Network Replenishment. Integrated process that copies missing video data from a video transceiver to the network video recorder after a network failure. The copied video data exactly fills the gap that occurred after the network failure. Hence the transceiver needs any kind of local storage. The recording capacity on this local storage is calculated with the following formula: $(\text{network bandwidth} \times \text{estimated network downtime} + \text{safety margin}) \times (1 + 1/\text{backup speed})$. The resulting recording capacity is required because the continuous recording must continue during the copy process.

area

A group of detection devices connected to the security system.

ASF

Advanced Systems Format; Microsoft Windows media audio and video format.

authenticity

State of a recorded video that indicates its originality. That means, the recorded video is not manipulated.

bookmark

Used for storing a time period of live or recorded video. This allows for tagging particular scenes for later investigation. Additionally you can share your investigation results with other users by exporting a bookmark.

bypass

Selectively remove points from the security system. A point may be bypassed in order to arm the perimeter with a window open.

camera sequence

A list of cameras that are displayed one after the other. Each camera is displayed for a specific time (dwell time). There are two types of sequences: predefined and automatic. Predefined sequences are defined by the administrator. Icons for these sequences are located in the Logical Tree. Automatic sequences are created when you drag a multiple selection or a folder from the Logical Tree to an Image pane or a decoder. All cameras in this folder or selection sequences in the Image pane. You can create your own sequences by creating a folder in your Favorites Tree.

Dewarping

The use of software to convert a circular image from a fisheye lens with radial distortion to a rectilinear image for normal viewing (dewarping is the correction of distortion).

DNS

Domain Name System. A DNS server converts a URL (www.myDevice.com, for example) into an IP address on networks that use the TCP/IP protocol.

dual authorization

Security policy that requires two different users to log on to the Operator Client. Both the users must be member of a normal Bosch Video Management System user group. This user group (or these user groups if the users are members of different user groups) must be part of a dual authorization group. A dual authorization group has its own

access rights within Bosch Video Management System. This dual authorization group should have more access rights than the normal user group that the user belongs to. Example: User A is member of a user group called Group A. User B is member of Group B. Additionally a dual authorization group is configured with Group A and Group B as members. For the users of Group A, dual authorization is optional, for users of Group B it is mandatory. When user A logs on, a second dialog box for confirming the logon is displayed. In this dialog box, a second user can log on if he is available. If not, user A can continue and start the Operator Client. He then has only the access rights of Group A. When user B logs on, again a second dialog box for logging on is displayed. In this dialog box, a second user must log on. If not, user B cannot start the Operator Client.

duplex

Term used to define the direction of data transmission between two parties. Half-duplex allows data transmission in both directions but not simultaneously. Full-duplex allows simultaneous data transmission.

Dwell time

Preset amount of time a camera is displayed in an Image window until the next camera is displayed during a camera sequence.

Edge dewarping

Dewarping performed in the camera itself.

Encoder

Changes an analog stream to a digital stream, e.g., to integrate analog cameras in a digital system like Bosch Video Management System. Some encoders can have a local storage like a flash card, a USB hard disk, or they can store their video data on iSCSI devices. IP cameras have an encoder built in.

Enterprise Account

Enterprise Account is an authorization that enables a user of Operator Client to connect to the devices of a Management Server being part of an Enterprise System. In an Enterprise Account, all permissions for the devices of this Management Server are configured. Operator Client can simultaneously connect to all

Management Server computers that are part of this Enterprise System. This access is either controlled by the membership to an Enterprise User Group, and is controlled by the device permissions configured in the Enterprise Account for this Management Server.

Enterprise System

Enterprise System is a feature of Bosch Video Management System that allows a user of Operator Client to access multiple Management Server computers simultaneously.

Enterprise User Group

Enterprise User Group is a user group that is configured on an Enterprise Management Server. Enterprise User Group defines the users that are authorized to access multiple Management Server computers simultaneously. Defines the operating permissions available for these users.

erase

The right of erasure in the GDPR (General Data Protection Regulation) provides that the data subject has the right to request erasure of personal data related to them on any one of a number of grounds within 30 days.

Event

A circumstance or state that is linked to an alarm and/or an action. Events can arise from many sources such as cameras, archivers, directories, digital inputs, etc. They can include start-recording states, loss of signal states, disk full messages, user logons, digital input triggers, etc.

Failover VRM

Software in the BVMS environment. Takes over the task of the assigned Primary VRM or Secondary VRM in case of failure.

Favorites Tree

Hotspot

Mouse sensitive icon on a map. Hotspots are configured in Configuration Client. Hotspots can be for example cameras, relays, inputs. The operator uses it for localizing and selecting a device in a building. If configured, hotspots can display a blinking background color when a specific state event or alarm occurs.

Image pane

Used for displaying live and recorded video of a single camera, a map, or an HTML file.

Image pane pattern

Arrangement of Image panes.

Image window

Container for Image panes, structured by an Image window pattern.

Instant playback

Plays the recorded image of the selected camera in an Image pane on the live screen. The start time (number of seconds in the past, or rewind time) can be configured.

Intelligent Tracking

Intelligent Tracking is a software process running on a camera that allows the camera to follow a selected object.

Intelligent Video Analytics

Algorithm that detects specific properties and the behavior of objects in a scene monitored by a video camera and from this generates alarm events that, in turn, can be processed in a CCTV system. Recording with Intelligent Video Analytics settings activated is a precondition to be able to selectively and quickly search through video material later. Intelligent Video Analytics makes it possible to capture and evaluate directional movement of objects in such a way that false alarms are prevented to a large extent. Intelligent Video Analytics adapts automatically to changing environmental conditions and is therefore largely non-sensitive to perturbing influences such as rain and tree movement. Especially when used for forensic search, Intelligent Video Analytics allows for filtering moving objects by their color specifications. With the aid of Intelligent Video Analytics algorithm extensive video material can be searched selectively for objects with specific color properties.

Intercom functionality

Used to talk on the loudspeakers of an encoder. This encoder must have audio-in and audio-out. The Intercom functionality can be granted per user group.

intrusion control panel

Generic name for the core device in a Bosch intrusion (burglary) security system. Keypads, modules, detectors, and other devices connect to the control panel.

iSCSI

Internet Small Computer System Interface. Protocol that manages storage via a TCP/IP network. iSCSI enables access to stored data from everywhere in the network. Especially with the advent of Gigabit Ethernet, it has become affordable to attach iSCSI storage servers simply as remote hard disks to a computer network. In iSCSI terminology, the server providing storage resources is called an iSCSI target, while the client connecting to the server and accessing the resources of the server is called iSCSI initiator.

Logbook

Container for logging all events in Bosch Video Management System.

Logical number

Logical numbers are unique IDs assigned to each device in the system for ease of reference. Logical numbers are only unique within a particular device type. Typical use of logical numbers are Command Scripts.

Logical Tree

Tree with a customized structure of all the devices. The Logical Tree is used in the Operator Client to select cameras and other devices. In the Configuration Client, the "Full Logical Tree" is configured (on the Maps and Structure page) and tailored for each user group (on the User Groups page).

Management Server

BVMS server managing devices.

monitor group

A set of monitors connected to decoders. The monitor group can be used for alarm processing in a given physical area. For example, an installation with three physically separated control rooms might have three monitor groups. The monitors in an monitor group are logically configured into rows and columns and can be set to different layouts, e. g. full-screen or quad view.

MOV

File extension of the default video format used by QuickTime Player from Apple.

No-touch deployment

Method for automatic downloading, installing and running .NET applications without changing the registry or shared system components. With Bosch Video Management System, no-touch deployment is used for updating the Operator Clients from the Management Server. The update takes place if a new version is stored on the Management Server and when each user is logging on to the Operator Client. If you work with one Operator Client against multiple Management Server computers, no-touch deployment uses only the software version stored on the Management Server where the Operator Client has last logged on successfully. When you try to log on to another Management Server with a different application version, this one displays the Management Server as not online because the software versions do not match.

NVR

Bosch Network Video Recorder; computer in the Bosch Video Management System storing audio and video data, acting as Failover NVR, or as Redundant NVR. This NVR is different from the VIDOS NVR which can be integrated in Bosch Video Management System.

Operator Client

Component of Bosch Video Management System that provides the user interface for system monitoring and operation.

Operator Client workstation

Computer in the Bosch Video Management System environment for viewing live and playback video and for configuration tasks. Operator Client is installed on this computer.

Panoramic camera

Camera with a 360° or 180° view angle.

Playback Mode

Feature of Operator Client. Used to playback and search through archived videos.

point

A detection device connected to the security system. Points show on the keypad individually and with custom text. The text might describe a single door, motion sensor, smoke detector, or an protected space such as UPSTAIRS or GARAGE.

PTZ camera

Camera with pan, tilt, and zoom function.

Reference image

A reference image is continuously compared with the current video image. If the current video image in the marked areas differs from the reference image, an alarm is triggered. This allows you to detect tampering that would otherwise not be detected, for example if the camera is turned.

Rewind time

Number of seconds when an Image pane is switched to instant playback.

ROI

Region of Interest. Intended use of ROI is to save bandwidth when zooming into a section of the camera image with a fixed HD camera. This section behaves like a PTZ camera.

Secondary VRM

Software in the BVMS environment. Ensures that the recording performed by one or multiple Primary VRMs is additionally and simultaneously performed to another iSCSI target. The recording settings can deviate from the settings of the Primary VRM.

Server Lookup

Access method for a user of Configuration Client or Operator Client to sequentially connect to multiple system access points. A system access point can be a Management Server or an Enterprise Management Server.

Site

User-created entity for grouping related system resources together for ease of viewing and management. Typically, a site corresponds to a physical location, like a building or a floor, but it may be used to represent any concept. It consists of a Management Server, usually Configuration Client and multiple Operator Client installations.

TCP

Transmission Control Protocol. Connection-oriented communication protocol used to transmit data over an IP network. Offers a reliable and ordered data transmission.

Timeline

Part of the Bosch Video Management System user interface. Displays lines as graphical representations of the recordings of the selected cameras. The Timeline allows you to navigate through recorded videos.

Trunk line

Analog outputs of an analog matrix that are connected to an encoder device. Thereby matrix video sources can be used in the Bosch Video Management System.

UDP

User Datagram Protocol. A connectionless protocol used to exchange data over an IP network. UDP is more efficient than TCP for video transmission because of lower overhead.

unmanaged site

Item of the Device Tree in BVMS that can contain video network devices like Digital Video Recorders. These devices are not managed by the Management Server of your system. The user of Operator Client can connect to the devices of an unmanaged site on demand.

User group

User groups are used to define common user attributes, such as permissions, privileges and PTZ priority. By becoming a member of a group, a user automatically inherits all the attributes of the group.

UTC

Universal Time Coordinated

Video Analytics

Video analytics is a software process that compares a camera image with the stored images of specific persons or objects. In case of a match, the software triggers an alarm.

Video Streaming Gateway (VSG)

Virtual device that allows integrating Bosch cameras, ONVIF cameras, JPEG cameras, RTSP encoders.

view

Collection of cameras assigned to Image panes that you can recall for instant live viewing. Image panes with maps or HTML files can be part of a view. Sequences cannot be part of a view.

VRM

Video Recording Manager. Software package in Bosch Video Management System which manages storing video (MPEG-4 SH++, H.264 and H.265) with audio data and metadata on iSCSI devices in the network. VRM maintains a database containing the recording source information and a list of associated iSCSI drives. VRM is realized as a service running on a computer in the Bosch Video Management System network. VRM does not store video data itself but distributes storage capacities on iSCSI devices to the encoders, while handling load balancing between multiple iSCSI devices. VRM streams playback from iSCSI to Operator Clients.

Index

A	
accept new configuration	36
accessing the Help	8
add bookmark	63
additional data	
text data	24
alarm camera	
analog monitor	83
Alarm Images window	44
alarm map	58
alarm recording	44
find	77
NVR recordings	44
VRM recordings	44
alarm sequence	106
analog monitor group	105, 108
application windows	102
area	109
arm	90, 91
audio	46, 50
Audio Intercom functionality	50, 122
authentication	70, 142
authenticity	128
automatic alarm popup behavior	21
automatic display of alarms	21
automatic pop-up alarm	102
automatic sequence	45
B	
blinking device icon	58
bookmark	61
add	63
display	64
edit	61, 64, 123, 124
load	64
save	63
Bosch IntuiKey keyboard	
analog mode	100
Command Mode	99
digital mode	96
icons	99
Bosch Video Management System	
Online Help	8
BVMS Archive Player	135, 137, 138, 139, 145
bypass	
point	90
C	
camera round	45
camera sequence	45
automatic	45
pre-configured	45
CCTV keyboard	93
change password	37
check authenticity	70, 142
color	128
Command Mode	99
Compatibility Mode	27
connection issues	56
crash	
Operator Client	145
D	
data sheet	12
decline new configuration	36
decoupled	25
delete user	37
delete video	128
digital keyboard	93
digital zoom	47, 62
disarm	90, 91
disconnected	25
displaying	
screens	39
dome camera	58, 59, 60
DWF files	
initial view	58
E	
edit bookmark	64
Enterprise System	15
entire screen	48
exit	
Operator Client	36
export	
split	136, 138, 140
video	128, 135, 138, 139
F	
Favorite	62
find alarm recording	77
find motion	77
find text data	77, 119
find video	77
finding	
information in the Help	8
Logbook entries	76, 116
force arm	90, 91
Forensic Search	74

full-screen mode	48	N	
G		new configuration available	36
general settings	120	NVR	12
H		NVR recordings	
Hairline	128	alarm recording	44
HD camera	121	O	
help	8	offline	25, 37
HTML files	126	Offline Mode	24
I		online application Help	8
icons	109	Operator Client	
Bosch IntuiKey keyboard	99	quit	36
Image pane	40, 43, 48, 127	start	36
in-window PTZ	59	options	120
image section	47, 62	P	
Image window	126	panoramic camera	
import		viewing modes	28, 41
video data	74	password change	37
import exported video	74	playback	104
Independent Operator Client	24	playback control	
initial view		jump to latest recording	129
DWF files	58	jump to oldest recording	129
instant playback	47, 49	pause	129
instant replay	49	play	129
Intelligent Tracking	60	play backward	129
Intercom functionality	50	single frame backward	129
intrusion panel	109	single frame forward	129
IntuiKey keyboard	93	Playback Mode	104
in-window PTZ	59, 128	playback video	126
K		point	
KBD Universal XF keyboard	93	bypass	90
L		point in time	128
Live Mode	102, 125	pre-configured sequence	45
live video	102, 126	printing the Help	8
load		protect video	128
video data	74	PTZ blocking	52
Logbook	76, 116, 120	PTZ camera	58, 59, 60
Logical Tree		PTZ control	126
search	42	blocking	52
M		push-to-talk	50
malfunction relay	23	Q	
Management Server	12, 15, 25	quit	
manual recording	27, 44	Operator Client	36
map	126	R	
blinking device icon	58	recording quality	44
colored device icon	58	recording source	81, 127
motion search	74, 75	reference image	52, 115
multichannel	46	refuse new configuration	36

Region of Interest	21	used icons	109
relay		user	
malfunction	23	delete	37
Release Notes	12	remove	37
Remote export	27, 135, 138, 139	V	
remove user	37	VCA	
resize	43	disable	49, 75
restrict video	68, 132	enable	49, 75
ROI	21	verify authenticity	70, 142
S		video	
save bookmark	63	export	135, 138, 139
search		find	77
Logical Tree	42	video data	
search for alarm recording	77	import	74
search for motion	74, 75, 77, 128	load	74
search for recorded video	77	View	62
search for text data	77, 119	view camera	40
searching for Logbook entries	76, 116	viewing	
sequence	45	screens	39
shortcuts	144	viewing modes of panoramic camera	28, 41
single frame		VRM recordings	
backward	129	alarm recording	44
forward	129	Z	
smart motion search	75, 128	ZIP export	73
sound	102		
specific event	128		
split export	136, 138, 140		
start			
Operator Client	36		
stream selection	54		
switch			
panoramic viewing mode	41		
system requirements	12		
T			
TCP	56		
text data			
find	77, 119		
time zone	10, 103, 107, 116, 120, 128		
Timeline	104, 128		
toggle	44		
toolbar	48		
transcoded video	55, 80		
U			
unmanaged site access	76		
unrestrict video	133		
update reference image	52		



Bosch Security Systems B.V.

Torenallee 49

5617 BA Eindhoven

Netherlands

www.boschsecurity.com

© Bosch Security Systems B.V., 2019