

Access Modular Controller 2

ADS-AMC2-4WCF | APC-AMC2-4WCF

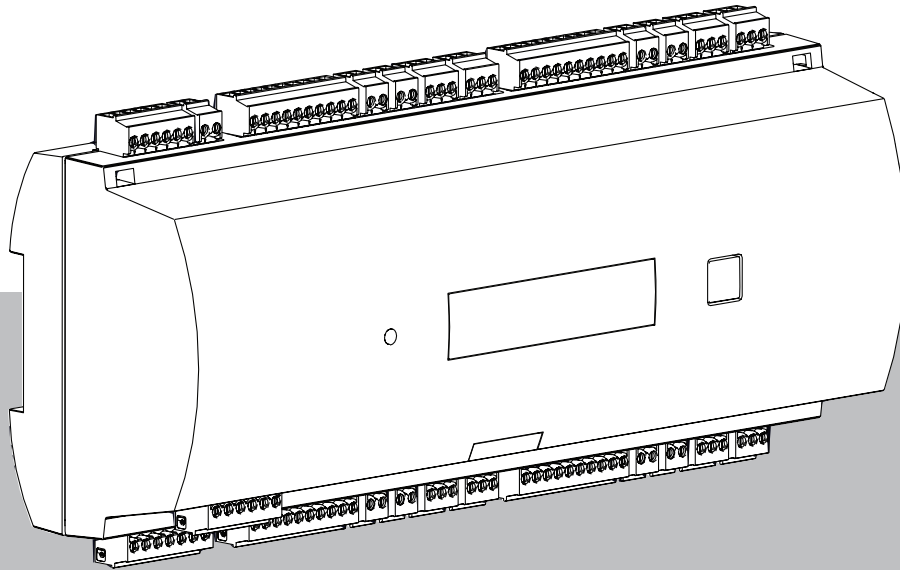

Table of contents

1	Safety	5
1.1	FCC Class B	6
2	Short information	7
3	Introduction	8
3.1	Description	8
3.2	Product overview	10
3.2.1	Mainboard	10
3.2.2	Status display	12
3.3	System overview	13
4	Installing	14
4.1	Mounting the device on a mounting rail	14
4.2	Unmounting the device from a mounting rail	14
4.3	Opening the case	15
4.4	Closing the case	16
4.5	Cabling	17
4.5.1	Conductor data for powering the controller	17
4.6	Grounding and shielding	18
4.6.1	Grounding for host Interface	18
4.6.2	Grounding for extension interface	19
4.7	Connecting the power supply to the controller	20
4.8	Ethernet host interface	21
4.9	RS-485 host interface	22
4.9.1	RS-485 Two Wire Connection	23
4.9.2	RS-485 Four Wire Connection	23
4.9.3	DIP switch selector	23
4.10	RS-485 for extension modules	26
4.11	Wiegand interface for card readers	27
4.12	Connecting relay outputs	28
4.13	Connecting analog input devices	30
4.14	Tamper protection	32
5	Operating	33
5.1	Configuring Ethernet interface	33
6	UL requirements	34
6.1	System requirements	35
6.1.1	Computer	35
6.2	UL 294 level descriptions	35
6.3	Installation instructions	35
6.4	Extended technical specification	38
6.4.1	RS-485 extension	38
6.4.2	Power consumption	38
7	Troubleshooting	39
7.1	Resetting the software	40
7.2	Resetting the device to factory default	41
8	Service and repair	42
9	Disposal	43
10	Technical specifications	44
11	Appendices	46
11.1	Connecting diagrams	46

11.2	Status display	49
11.2.1	Bootloader V00.49	49
11.2.2	Firmware until 6x.45, 37.60	50
11.2.3	Firmware xx.61, 37.71	51
11.2.4	Firmware xx.62, 37.72	52

1 Safety

**Warning!****Read instructions**

Before working with the device, read these instructions carefully. Make sure you have understood all information described in this document.

**Caution!****Fire hazard and risk of electric shock due to unauthorized spare parts and accessories**

Unauthorized spare parts and accessories might lack grounding wires or other safety elements. External power supplies must be installed by qualified personnel. The service technician must use replacement parts or accessories that are specified by the manufacturer.

**Warning!****Risk of explosion of lithium battery**

The battery can explode if it is replaced incorrectly. Pay attention to the correct polarity when inserting.

Replace only with the same battery type, as recommended by the manufacturer.

Do not overheat or expose to fire, mechanical force, or unusual high/low air pressure conditions.

**Warning!****Risk of physical injury due to blocked escape routes**

This product may block escape routes if not installed correctly. To keep escape routes free:

- Use locks in fail-safe mode, so that doors can be released if power fails.
- Install manual override switches, such as break-glass or lever stations, to unlock doors in an emergency.

**Notice!**

Dispose used batteries according to the battery manufacturer's instructions, local laws and regulations. Batteries must be disposed of separately from household waste.

**Notice!****Device damage due to incorrect mounting**

Mount this product on the matching mounting rails.

If the device falls or is damaged, check it before the installation.

**Notice!****Considerations on local regulations**

When you install the device, consider any local fire, health and safety regulations.

**Notice!****Device damage due to electrostatic discharge**

Protect the hardware from electrostatic discharge, especially when the device is open and exposed. Always disconnect the controller from the power source before modifying the installation. This product does not support hot plugging.

**Notice!****Unauthorized access**

If this product is installed in an unprotected environment, unauthorized people may be able to enter.

Install the product in a location with restricted access.

This device is not suitable for use in locations where children may be present.

**Notice!**

Some features and functions described in this document depend on the firmware loaded into the device and host software. Make sure that the controller is updated to the firmware version provided with the host system.

This product is RoHS compliant. See Technical data for the full table of hazardous components.

1.1**FCC Class B**

This device complies with part 15 of the FCC Rules. Operation is subject to the following two conditions: (1) This device may not cause harmful interference, and (2) this device must accept any interference received, including interference that may cause undesired operation. Changes or modifications not expressly approved by the party responsible for compliance could void the user's authority to operate the equipment.

Note: This equipment has been tested and found to comply with the limits for a Class B digital device, pursuant to Part 15 of the FCC Rules. These limits are designed to provide reasonable protection against harmful interference in a residential installation. This equipment generates, uses, and can radiate radio frequency energy and, if not installed and used in accordance with the instructions, may cause harmful interference to radio communications. However, there is no guarantee that interference will not occur in a particular installation. If this equipment does cause harmful interference to radio or television reception, which can be determined by turning the equipment off and on, the user is encouraged to try to correct the interference by one or more of the following measures:

- Reorient or relocate the receiving antenna.
- Increase the separation between the equipment and receiver.
- Connect the equipment into an outlet on a circuit different from that to which the receiver is connected.
- Consult the dealer or an experienced radio/TV technician for help.

2 Short information

This controller is able to control up to four Wiegand card readers.

It is designed to fully process the access logic at assigned access points. Access points consist of doors, gates, barriers, turn stiles, revolving doors, mantraps, ID card readers, door opening elements and sensors.

All the product versions use encrypted connections between the access modular controller and the host system.

The controller stores all necessary information in a battery-buffered memory and in a compact flash storage element. Even when the unit is offline, it is able to perform:

- Independent status and authorization checks on access points
- Take access decisions
- Activate and deactivate connected peripheral elements
- Detect and register all relevant events

The Access Modular Controller (AMC) is supported by the Access Professional Edition (APE), BIS Access Engine (ACE) and the Access Management System (AMS).

For the latest information about our products, visit our online product catalog:

www.boschsecurity.com/xc/en/product-catalog/

Manufacturing dates

For product manufacturing dates, go to www.boschsecurity.com/datecodes/ and refer to the serial number on the product label.

Remarks

This hardware is part of a security system.

Access should be granted to authorized people only.

Some states do not allow the exclusion or limitation of implied warranties, or limitation of liability for incidental or consequential damages, hence the above limitation or exclusion might not apply to you.

If you need further assistance or have any questions, contact:

Bosch Security Systems B.V.

Torenallee 49
5617 BA Eindhoven
Netherlands

www.boschsecurity.com

© Bosch Security Systems B.V., 2023

3 Introduction

3.1 Description

The controller is equipped with four independent interfaces for Wiegand type readers. It is able to control two doors with one reader in each direction and up to four doors with a reader in one direction only.

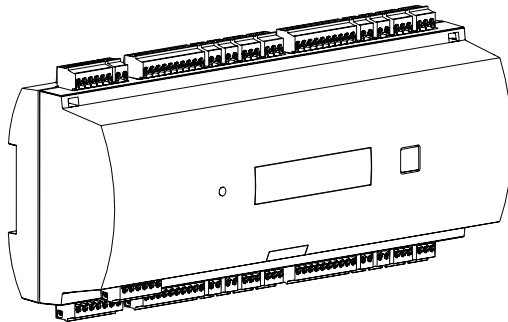

Figure 3.1: Access Modular Controller

All necessary information for access verification is stored in a battery buffered on-board memory and a Compact Flash (CF) memory card. This guarantees autonomous access decisions and complete access registrations even if the management host system is offline. The built in compact flash adapter provides adequate storage capability for cardholders and events.

The electronics of the controller are completely covered by a plastic housing. The LCD (liquid crystal display) provides all important status information.

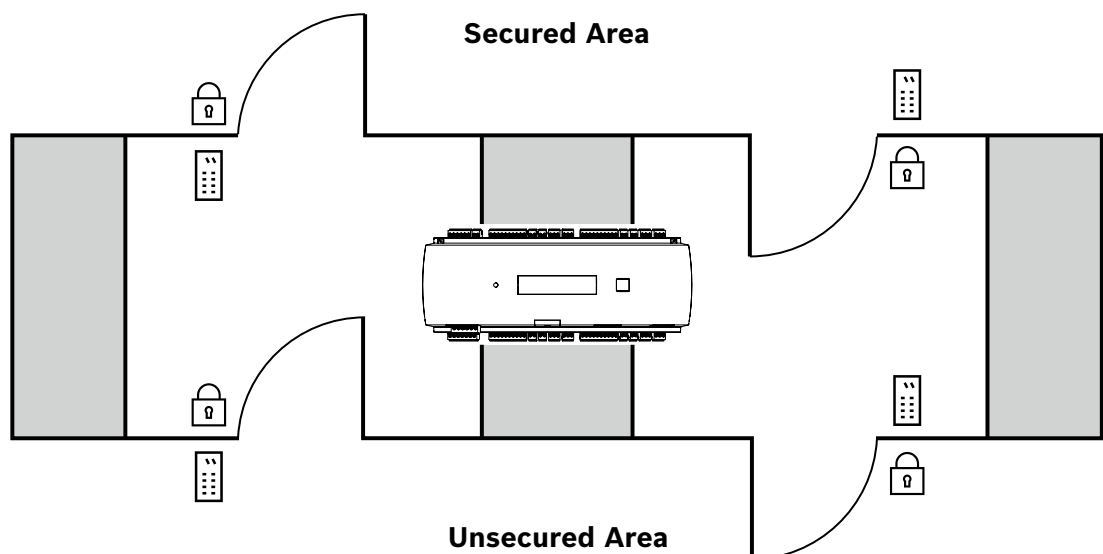

Figure 3.2: Example

The controller can communicate upstream to the host computer using one of the following interfaces:

- Ethernet

- RS-485 multi-dropped, not supported by:
 - BIS 4.9.1 and later
 - AMS 4.0 and later.

The controller has eight analog input devices and eight relay outputs. With its analog input devices, the controller verifies, for example, if a lock is closed or open. The relay outputs can be used, for example, to activate lock mechanisms if access is granted, or activate the burglar alarm system if an intrusion or system alert is detected. If the eight inputs and eight outputs on the board are not enough to configure the system, up to three additional extension boards can be connected. The extensions offer 8 or 16 additional inputs and outputs.

In the Bosch Access Host Systems, the setup procedure for a controller is made very simple and fast by the use of door templates. Once selected, all the inputs and outputs are predefined. These settings can be changed to choose every free contact of the controller or a connected extension.

The product name and marking can be found on the backside of the product housing.

3.2 Product overview

3.2.1 Mainboard

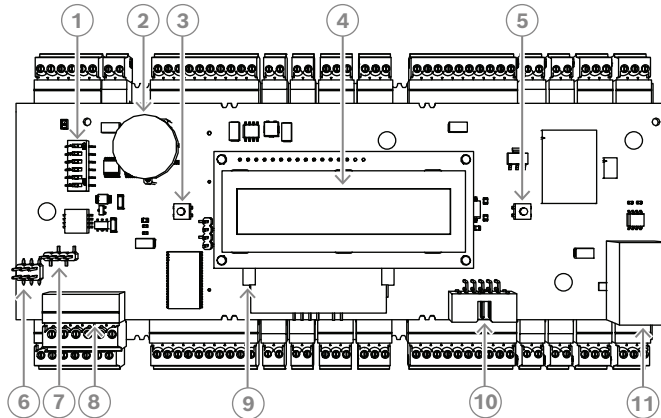

Figure 3.3: Upper circuit board with display (front)

1	DIP switch for RS-485 address and protocol selection.
2	Lithium battery for buffering of static RAM and real time clock (RTC). The battery life is estimated at 10 years, nevertheless an error message is generated if the voltage sinks below a preset minimum level. NOTICE: In order to avoid an error message caused by an earlier voltage drop we suggest to replace the battery every 8 years. Spare part: VARTA CR 2032 PCB.
3	Reset push button - reachable through the casing using a screwdriver
4	Liquid Crystal Display
5	Push button, available on top of the housing, to select different display modes
6	Jumper: Equalization of potential between different systems and earth ground (shield)
7	Jumper: Interface selector RS-485 host connection, RS-485 two wire or RS-485 four wire (depends on external wiring)
8	Configurable RS-485 host interface
9	Compact flash memory
10	Project-specific interface
11	Configurable 10/100 Mbit/s Ethernet host interface

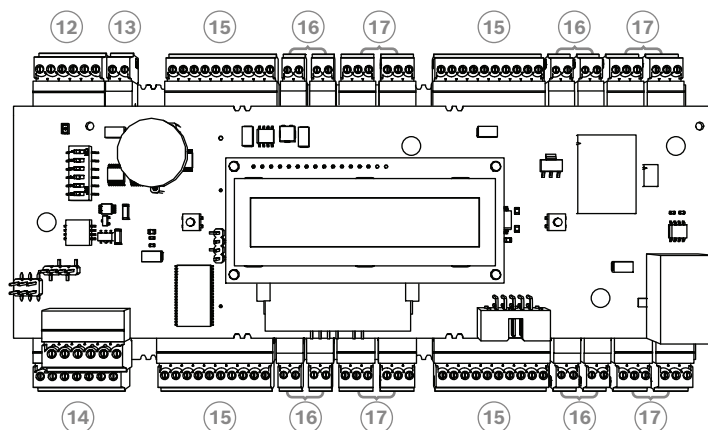

Figure 3.4: Interfaces - overview

12	RS-485 extension module bus
13	External tamper contact
14	Connector for power supply
15	Wiegand interfaces for card readers
16	Connectors for analog inputs
17	Connectors for relay outputs

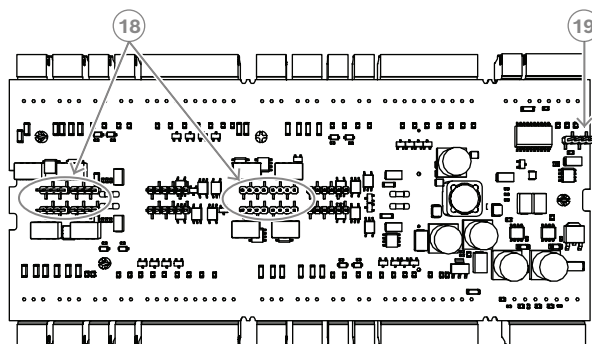

Figure 3.5: Jumper (back)

18	Jumper for setting either voltage free relay output (“dry” mode) or looped-in voltage from the AMC internal power supply (“wet” mode).
19	Jumper: Equalization of potential between different systems and earth ground (shield) for the extension interface.

3.2.2 Status display

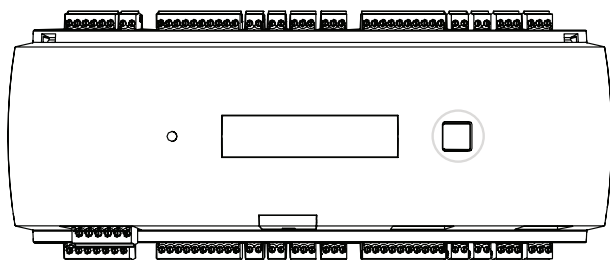

Figure 3.6: Dialog button of the controller

The liquid crystal display delivers status information about the controller. Push the dialog button to switch between different modes.

The selected display mode remains set until the next time the button is pressed.

The display pages depend on the firmware loaded into the controller. The order of the display pages available on delivery (Bootloader V00.49) is shown in the following table.

For information on display pages available for the different firmware (FW) variants, refer to *Status display, page 49*.

Push	Display (Example)	Description
0	V00.49 dd.mm.yy	Bootloader version by factory dd.mm.yy release date of the firmware
1	S/N1: 0910024419	Serial number 18 digits - Part1 10 digits
2	S/N2: 22850034	Part 2 - 8 digits
3	11.18 12:24:18 S	Current date and time (MM.DD hh:mm:ss) (S) = daylight saving
4	MAC 001B860012AB	Network device address (MAC)
5	N AMC-1234-5678	Network name of the controller (max. 14 char.) <i>See Configuring Ethernet interface, page 33.</i>
6	I 192.168.10.18	IP-address of the controller
7	G 192.168.10.255	IP-address of the gateway
8	M 255.255.255.0	Subnetmask
9	H 192.168.10.10	IP-address of the host computer
10	DHCP 1	DHCP-status: 1 = on; 0 = off
11	D 192.168.10.1	IP-address of the DNS server
12	Host: + "C"	Host activity: + = online - = offline "C" = Counter (0 to 9) of the received data packages from the host interface. RS 485 Bus connection: A = Address 1 ... H = Address 8

3.3 System overview

The controller can be connected to the host system through one of the following interfaces, depending on the type of installation:

- Ethernet
- RS-485 multi-dropped, not supported by:
 - BIS 4.9.1 and later
 - AMS 4.0 and later.

The host interface is selected during installation.

The four reader interfaces are available on the device.

With RS485 operation, a maximum of eight access controllers can be connected to one party line.

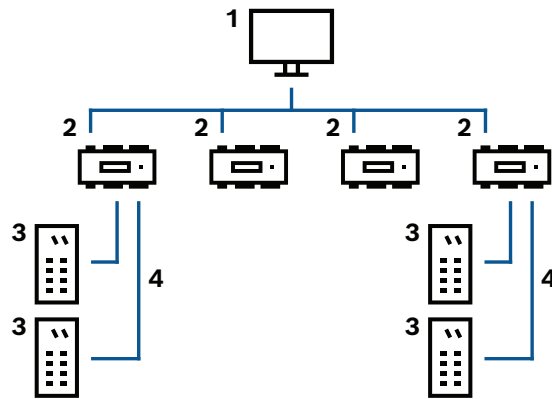

Figure 3.7: Example

1	Host computer
2	Access Modular Controller
3	Card reader
4	Communication and power supply

In the communication chain of a system, the access controller is integrated between the host system and the peripheral devices.

It is possible to connect a maximum of four readers to the access modular controller.

4 Installing

4.1 Mounting the device on a mounting rail

The controller can be attached on a standard 35 mm (1.377 in.) mounting rail using a snap-in mechanism. Attach the controller into the upper edge of the mounting rail [1], then push down the device and snap it onto the rail by pushing it towards the back [2].

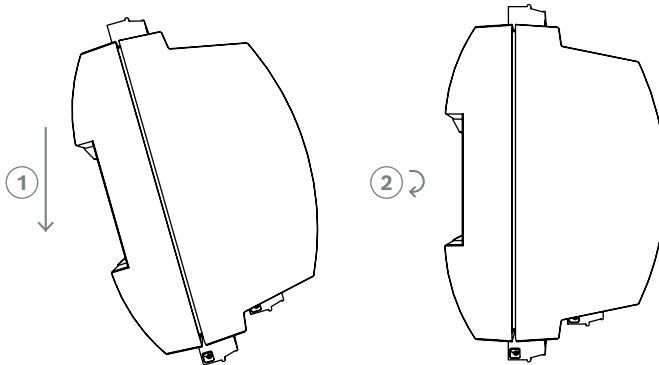

Figure 4.1: Mounting the controller on a mounting rail

For information on how to install the device in an enclosure, refer to the separate instruction manual of the enclosure AEC-AMC2-UL01 or AEC-AMC2-UL02. After installing the device, keep the door of the enclosure closed.

4.2 Unmounting the device from a mounting rail



Notice!

To remove the controller from a mounting rail, first remove all pluggable connectors.

Push down the controller until the lower edge snaps out of the mounting rail [1]. Pull the lower end of the controller from the mounting rail [2].

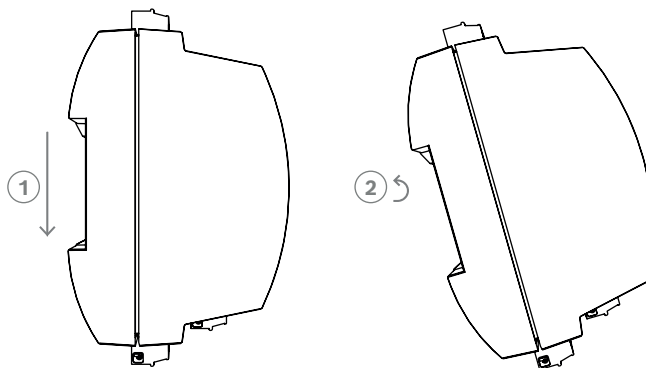

Figure 4.2: Unmounting the controller from a mounting rail

4.3 Opening the case

**Notice!**

To open the controller, first remove all pluggable connectors.

The controller's case consists of a top cover mounted with a two-point snap-in closure on a chassis. To open the case, push down the two snap-ins with a screwdriver, then swing the cover down.

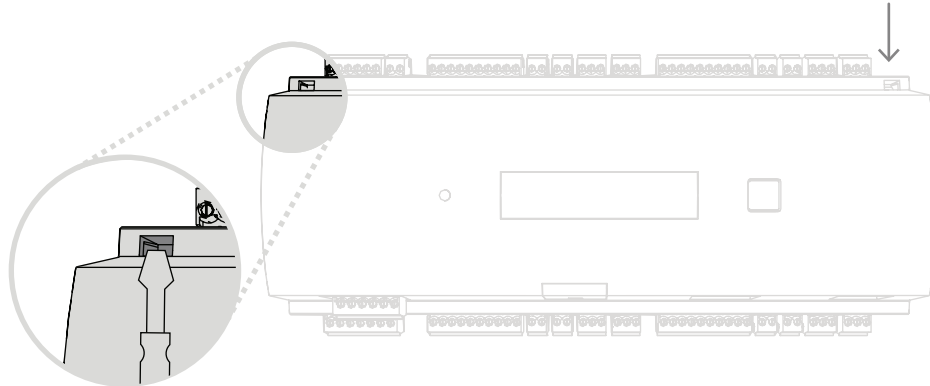

Figure 4.3: Opening the controller's case

4.4 Closing the case

Before aligning the covers, unplug any pluggable screw connectors. Insert the hooks on the lower edge of the front cover into the lugs on lower edge of the plastic back cover [1]. Please ensure that the BOSCH logo is not upside-down. The upper edge of the front cover now aligns with the two-point snap-in closures on the upper edge of the back cover [2], and may thus be clicked gently into place.

Hence the closing process is the reverse of the opening process.

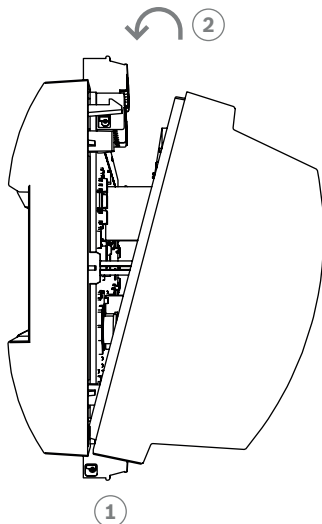

Figure 4.4: Closing the case



Notice!

Risk of damage to equipment

If excessive force is required to close the front cover then it is probably incorrectly hooked into the back cover. In such cases the display dialog button in the front cover will be misaligned and will not function correctly.

4.5 Cabling



Notice!

Risk of malfunction

The cables used in the controller are not prone to electrical interference. However, you should avoid routing cables close to heavy load switching cables and equipment. If this is unavoidable, cross the cable at right angles every 1 to 2 m (3 to 6 ft) to reduce interference.

4.5.1 Conductor data for powering the controller

With the calculation below you can find out which cable type must be used. If you connect the power supply and the controller with the delivered cable set from the enclosure the calculation is not necessary.

For distances below 25 m (75 ft) use AWG18 conductors (1mm²). For longer distances, install an additional power supply close to the controller.

Please, calculate the voltage drop by checking the conductor specifications for characteristic resistance values. The voltage drop shall not exceed 2 V.

Example:

Length = 100 m/328 ft

$$U = 12V, I = 1A, \text{maximum } U_{Drop} = 2V$$

$$i. e. \text{RAWG18 (acc. specs)} = 6.385 \frac{\Omega}{1000 \text{ ft}} \text{ or } 20,948 \frac{\Omega}{\text{km}}$$

$$U_{Drop} = 20,948 \frac{\Omega}{\text{km}} \times 0.1 \text{ km} \times 1A = 2.1V$$

$$U_{Drop} = 6.385 \frac{\Omega}{1000 \text{ ft}} \times 328 \text{ ft} \times 1A = 2.1V$$

Critical condition! Install the power supply closer to the controller.



Notice!

These specifications apply to power supply, readers, relay outputs, and extension interface. Regarding inputs, specific voltage-drop values need to be taken into account. Refer to Connecting Analog Input Devices.

4.6 Grounding and shielding

The main grounding point at the controller is connected to pin 2 of the power supply connector - see Connecting diagrams.

It is good practice to shield all wires carrying low level signals.

The controller allows you to create a central ground or shielding point, simply by setting certain jumpers. Set these jumpers only if grounding or shielding is not achieved by other means.



Notice!

The functional earth ground symbol  identifies a functional part that allows installing an electrical system in an electromagnetically compatible manner.



Notice!

Risk of malfunction
Ensure that no ground loops are formed.



Notice!

In general the following apply:

If the devices have their own power supplies, the shielding is applied to one side only. The free end should be insulated to avoid inadvertent connections.

If one device is fed power by another, the cable shielding should be applied to both sides.

4.6.1 Grounding for host Interface

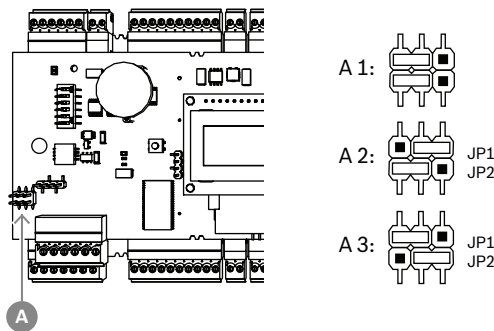

Figure 4.5: Location of ground jumper RS-485 host interface

A1	Delivery status
----	-----------------

The internal ground of the controller is always connected with the ground of the RS485 host. The jumper setting A1 shows the factory settings.

Jumper JP1 connects the internal ground of the controller to the ground of the RS-485 host interface.

Jumper JP2 manages the signal ground.

Settings for jumper JP1:

If the ground conductor and the shield on the host are not connected and:

- no party line exists, the jumper JP1 is set (= A2)
- a party line exists, the jumper JP1 is set at the first device only (= A2)

Settings for jumper JP2:

If the ground conductor and the shield on the host are not connected and:

- no party line exists, the jumper JP2 is set (= A3)
- a party line exists and signal ground is connected, the jumper JP2 is set at the first device only (= A3)
- a party line exists and signal ground is not connected, the jumper JP2 is set at all devices (= A3)

4.6.2 Grounding for extension interface

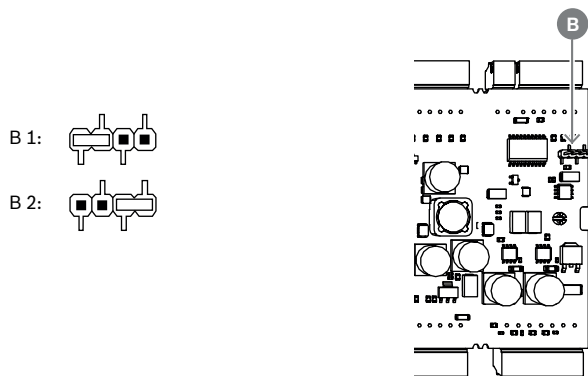

Figure 4.6: Location of ground jumper bottom side

B1	Delivery status
----	-----------------

Jumper B connects the internal ground of the controller to the RS-485 ground of the slave interface. Only set jumper B (B2) if the controller powers all other peripheral devices directly connected to it.

4.7 Connecting the power supply to the controller

Connect the power supply to the POWER 7-pin pluggable screw connector.

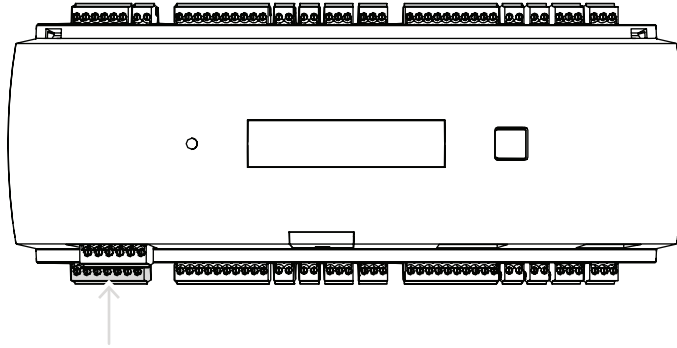

Figure 4.7: Location of the power supply connector

Connect an external power supply (10 VDC - 30 VDC) to the controller at pin 1 (positive) and pin 3 (0 V) of the pluggable screw connector.

Bosch recommends using the Bosch APS-PSU-60 power supply unit.

This power supply can also be used as an Uninterruptible Power Supply (UPS) when using the appropriate batteries. It also has relay outputs for monitoring the power good signals. These can be connected to:

- pin 4 and 7 for power good AC
- pin 5 and 7 for power good Battery
- pin 6 and 7 for power good DC.

If the recommended power supply is not in use, it is useful to have these pins short-circuit.

Notice!

If a battery is used, the power supply unit (PSU) checks the battery status every 5 minutes. During the self-test, the PSU switches its output from AC regulated power to battery regulated power. This causes the AMC to be supplied by the battery only.

Make sure that the battery is maintained according to the advice of the manufacturer, in order to reduce the risk of losing the power on the AMC controller during self-test.

The duration of this self-test is of approximately 1 second.

The **Power Good AC** signal is switched off during the self-test.

If no battery is connected, the PSU does not perform any self-test.

Depending on the security level of your building, it is recommended to replace the battery more frequently (e.g. every 3 years, in order to keep the system running properly).



Notice!

Unstable AC networks can result in various error messages on the host system. If this happens, the AMC only reports AC power losses of more than 10 minutes of duration. This time cannot be set.



4.8 Ethernet host interface

The controller offers a 10/100 Mbit/s Ethernet auto-sensing interface to connect to a local area network or host computer.

**Notice!**

Use a CAT5 network cable or higher version to connect the controller with the network.

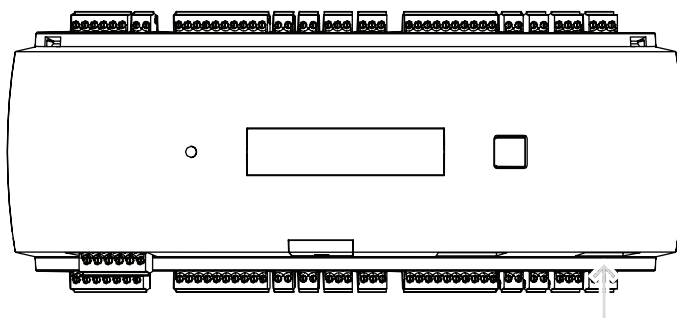

Figure 4.8: Location of the Ethernet interface

**Notice!**

After connecting a new controller to a network using DHCP, it can take some time before the new controller is recognized by the remote server.

You can accelerate this process by running the following command in a command console:

```
ipconfig /flushdns
```

This makes the controller immediately available by its name.

**Notice!**

When using an Ethernet connection, switches 1 and 5 of the DIP switch must be set to the ON position (= factory setting) (see Figure 3.3, item 1, *page 10*). This also ensures correct communication with the Bosch Building Integration System (BIS) and the Bosch Access Management System (AMS).

**Notice!**

Whenever an AMC is connected to a new switch, powered up or detects a new network link (e.g. because the switch rebooted or the cable was replaced), the AMC will announce its presence on the network link.

4.9 RS-485 host interface

The RS-485 interface is not supported by:

- BIS 4.9.1 and later
- AMS 4.0 and later.

The RS-485 host interface of the controller can be set for using a 2- or 4-wire connection. Up to eight controllers can be used on one host bus.

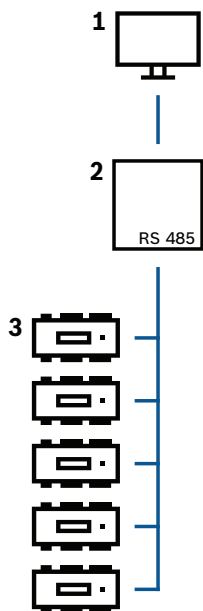

Figure 4.9: Configuration of a RS-485 host system

Position	Description
1	Host
2	RS-485 bus
3	Access Modular Controller

The following conditions apply for a RS-485 bus system:

- A bus system consists of a bus line and/or one or more branch lines.
- Cable lengths exceeding 100 m (300 ft) must be installed as bus lines.
- Branch lines are branching connections from a bus line.
- Peripheral devices are controllers which are connected to the host computer.
- Maximum cable length of a bus line must not exceed 1200 m (4000 ft).
- The cable length of branch lines must not exceed 100 m (330 ft).

To use RS-485 mode at the controller, connect the data cables to the pluggable screw connector of the RS-485 host interface.

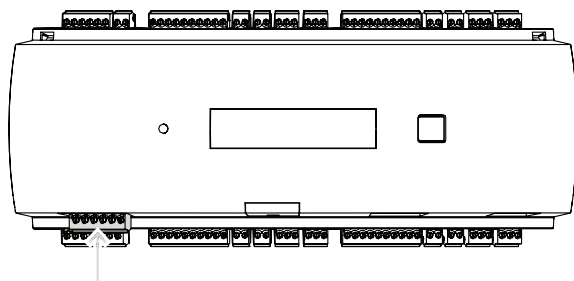

Figure 4.10: RS-485 host interface

4.9.1 RS-485 Two Wire Connection

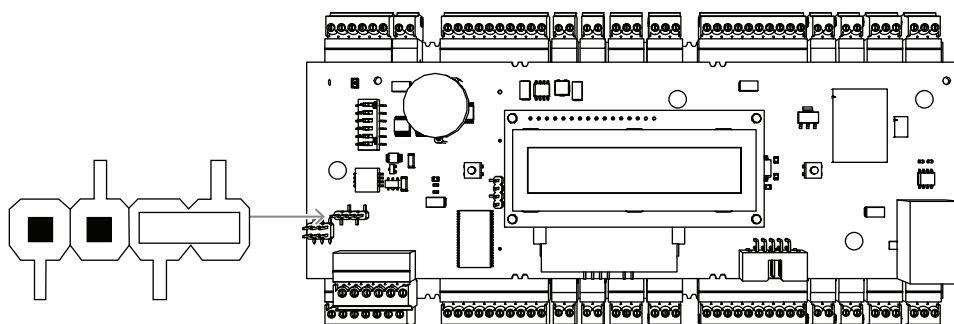

Figure 4.11: Setting of the jumpers for RS-485 two wire connections

4.9.2 RS-485 Four Wire Connection

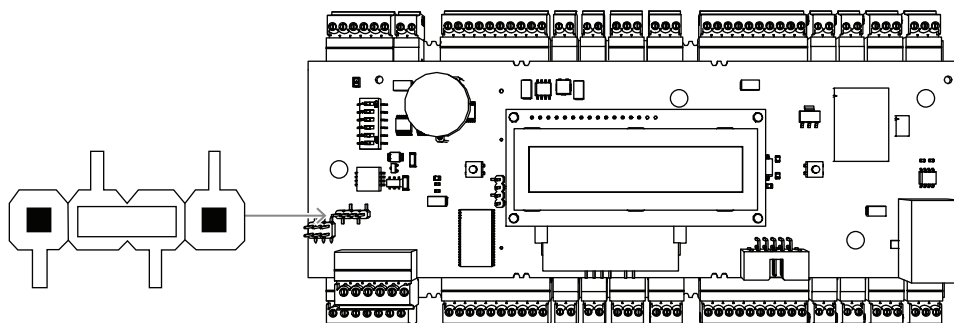

Figure 4.12: Settings for RS-485 four wire connection

Select the RS-485 address of the AMC2 controller using the DIP switch.



Notice!

If a four-wire connection is used the interface must be set up as a crosslink.

4.9.3 DIP switch selector

DIP switches are used to configure the host settings.

The first four DIP switches for address selection, define the RS-485 address of the AMC2 in an RS-485 bus system.

Switch 5 selects one of the two different protocols, SDEB and BPA (according to DIN6619).

Switch 6 sets the connection to the host system to either RS-485 or the Project-specific interface (PI).



Notice!

If using an Ethernet connection, set **switch 1** and **5** to **ON** (= delivery status).

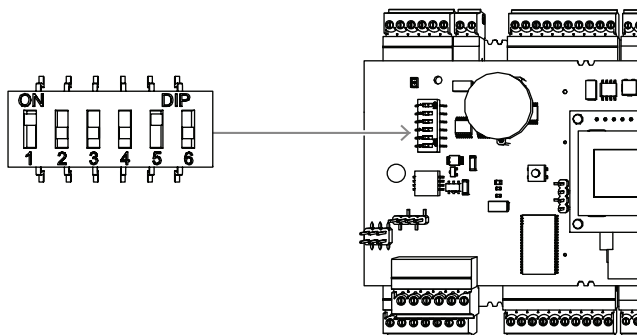

Figure 4.13: Location of the selector for host settings and delivery status

Address	DIP switches			
	1	2	3	4
none	OFF	OFF	OFF	OFF
1	ON	OFF	OFF	OFF
2	OFF	ON	OFF	OFF
3	ON	ON	OFF	OFF
4	OFF	OFF	ON	OFF
5	ON	OFF	ON	OFF
6	OFF	ON	ON	OFF
7	ON	ON	ON	OFF
8	OFF	OFF	OFF	ON

Table 4.1: Setting the address via the DIP switch

Mode	DIP switches	
	5	6
ON	SDEB	PI
OFF	BPA	RS-485

Table 4.2: Protocol and connection settings

Host settings

Instructions for DIP switch 5

Set **SDEB** (= DIP switch **5** to **ON**) in the following cases:

- Ethernet host connection
- RS-485 host connection, provided only one AMC2 is connected on the bus.

Set **BPA** (= DIP switch **5** to **OFF**) in the case of an:

- ▶ RS-485 host connection with more than one and maximum eight AMC2s per bus.



Notice!

Changing the type of the host connection requires a reset of the AMC2 - see *Resetting the software, page 40*.

4.10 RS-485 for extension modules

The RS485 Extension Module Bus expands the AMC2 with additional I/O modules (AMC2-8IOE, AMC2-16IE, AMC2-16IOE).

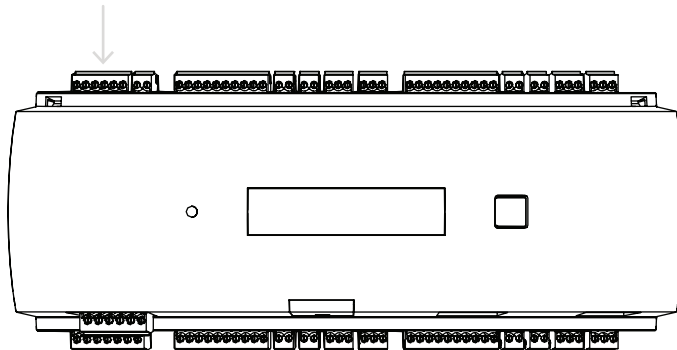

Figure 4.14: Location of the RS-485 extension module bus

Up to three expansion modules can be connected to provide additional in- and outputs, for example, for elevator control.

You can find further information about the extension boards in their installation manuals. A complete connection diagram of the RS485 extension module bus is shown in the chapter Connecting diagrams.

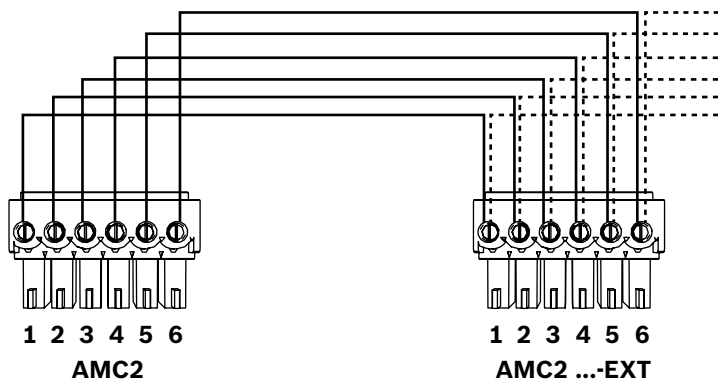

Figure 4.15: Connection of an extension module to a controller



Notice!

The address of the board is set using a switch on the board's underside (see Equipment Configuration).

The extension boards are assigned the addresses 1 to 3.

4.11 Wiegand interface for card readers

The AMC2 provides four ports for connecting a maximum of 4 readers with Wiegand interfaces. Each interface is connected using a 10-pin pluggable screw - refer to Connecting diagrams.

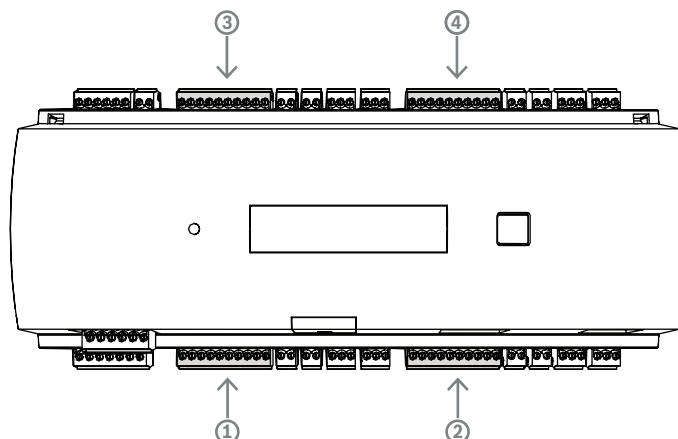

Figure 4.16: Location of the Wiegand interface (port) for readers

These interfaces are point-to-point connections, and each can support only a single reader with a maximum cable length of 90 m (300 ft) for 24 AWG or 150 m (500 ft) for 22 AWG. Readers are addressed according to their respective interface numbers.



Notice!

When wiring the readers, the voltage loss on the line must be taken into account. The voltage must be maintained according to the specifications of the reader.

If this is not the case, use a cable with a larger cross-section or a separate power supply with the reader.

4.12 Connecting relay outputs

To operate locks or alarm systems, the AMC2 has eight relay outputs. The outputs will be connected to the 3-pin pluggable screw connectors S5, S6, S10, S11, S17, S18, S22 and S23 - refer to chapter Connecting diagrams.

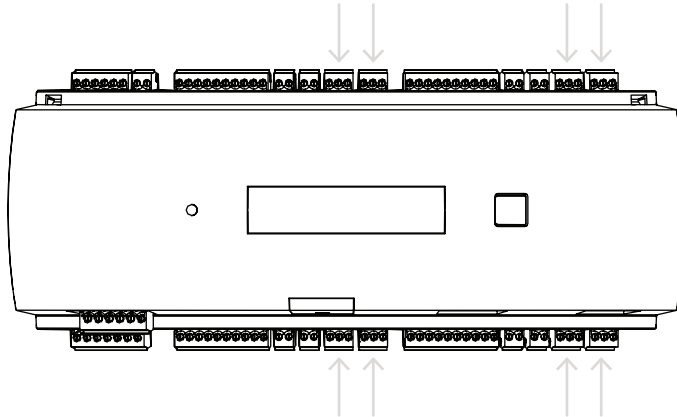

Figure 4.17: Location of the relay output connectors

By default, the relay outputs are connected as floating contacts (E1). However, it is possible to connect the internal voltage 12/24 V of the AMC2 to each relay output (E2) to control external consumers.

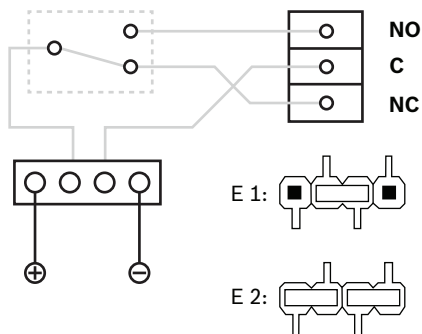

Figure 4.18: Relay mode settings

Notice!

Risk of damage to equipment

To prevent damage to the relays, note these specifications:

- The maximum switching current is 1.25 A.
- The maximum switching voltage is 30 VDC.
- Only OHM resistive load can be connected to the relay.
- Inductive loads have to be short circuited using recovery diodes. The diodes (1N4004) are supplied with every controller.
- If you need higher voltage or current for special applications, or electric door holding magnets, you have to use coupling relays (e.g. Wieland flare move) on the outputs.
- Note that the coupling relays must be selected according to the supply voltage (12 V, 24 V) of the controller.



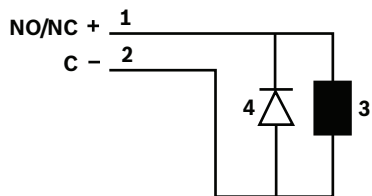

Figure 4.19: Recovery diode schematic

1	Normally open / normally closed	2	Common
3	Inductive load	4	Recovery diode



Notice!

When you use the recovery diode, make sure to use it in the reverse direction.

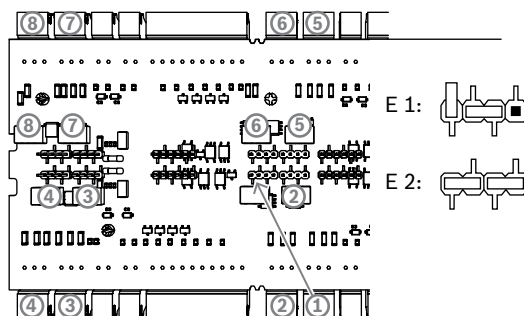

Figure 4.20: Location of the relay output jumpers (bottom side)

E1	Delivery status
----	-----------------



Notice!

The positions of the jumpers 1 and 2 are interchanged related to the corresponding interfaces.

4.13 Connecting analog input devices

The AMC2 has eight analog inputs, for example, for potential-free lock mechanisms, or to detect whether a lock is closed or open. The inputs will be connected to the 2-pin pluggable screw connectors: S3, S4, S8, S9, S15, S16, S20 and S21 - refer to Connecting diagrams.



Notice!

Risk of damage to equipment

Do not connect external power supply to the AMC2 inputs.

When connecting a relay output to an AMC2 input use dry mode with potential-free contact - refer to *Connecting relay outputs*, page 28.

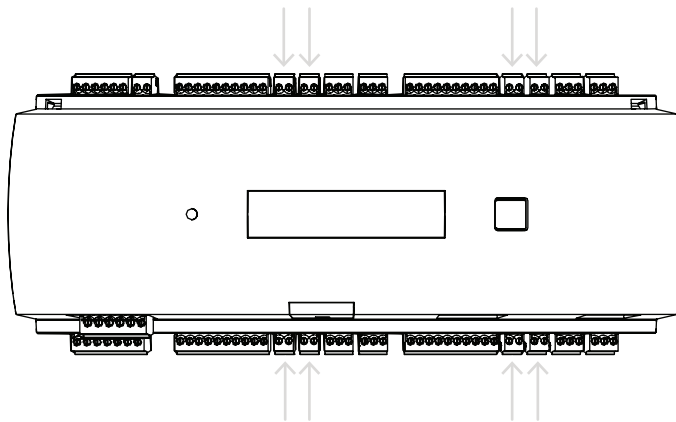

Figure 4.21: Location of the analog input connectors

The AMC2 can also detect the wiring conditions ‘short circuit’ and ‘broken’, and hence trigger an alarm if the appropriate devices are connected.

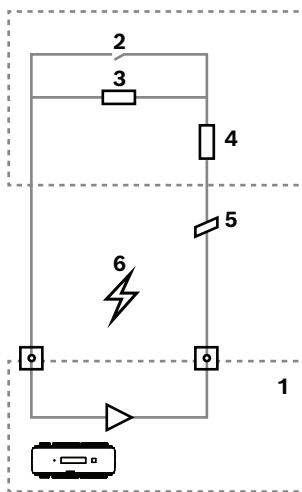

Figure 4.22: Circuit diagram

1	AMC2 analog input	2	Monitoring / door contact
3	Resistor parallel (R_p)	4	Resistor serial (R_s)
5	Broken wire	6	Short circuit

- Door open: $R_s + R_p$
- Door closed: R_s
- Open wire: $R_s + R_p = \infty$
- Short circuit: $R_s + R_p = 0$

The resistor values can vary and depend on the used lock system.

The extension package includes 2.2 k Ω resistors which can be used to replace R_S and R_P resistors.

To detect the four states, the voltage drop in the connecting cable may not exceed special values. The following table shows the maximum values of permissible cable resistance depending on the used resistor combination.

R _P	1k	1k2	1k5	1k8	2k2	2k7	3k3	3k9	4k7	5k6	6k8	8k2
R _S												
1k	220	220	220	210	200							
1k2	260	270	270	270	260	240						
1k5	310	330	340	350	350	340	310	280				
1k8	340	380	390	410	410	410	400	370	330	290	200	
2k2		430	460	490	510	520	510	500	460	420	340	240
2k7		490	540	570	620	630	640	640	620	580	510	420
3k3			610	650	700	740	770	780	770	750	700	620
3k9				720	790	850	890	910	910	910	880	810
4k7					880	960	960	970	1100	1100	1050	1050
5k6						1050	1100	1200	1200	1300	1300	1250
6k8							1300	1400	1500	1500	1500	1500
8k2								1500	1650	1700	1800	1900

Table 4.3: Maximum values of cable resistance per used resistor combination in Ohm

4.14 Tamper protection

To protect the AMC2 against unauthorized access and so prevent tampering with sensitive data, the AMC2 provides an additional interface to connect external tamper contacts. This interface is a potential-free 2-pin pluggable screw connector marked with **T**. When not in use this tamper contact should be shorted.

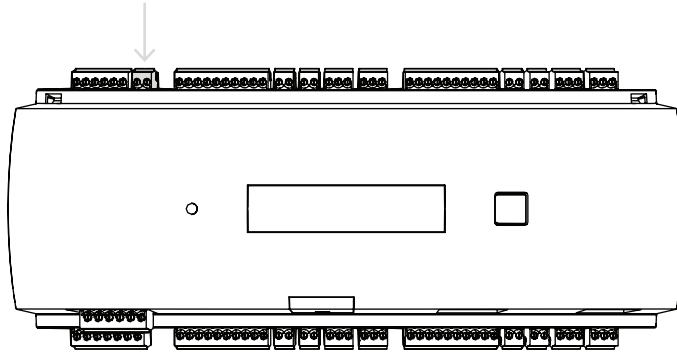

Figure 4.23: Location of the tamper protection contact

5

Operating

5.1

Configuring Ethernet interface

To configure the controller in a TCP/IP network environment, use the controllers IPConfig tool of the access control system. The tool is delivered with the access host system software.

Refer to the online help of the IPConfig for details on configuring the controller.

For further information refer to the documentation of the corresponding access system.

To ensure that the controller can communicate with the software follow these naming rules:

- Use only alphanumeric characters plus the separator "-" (minus/dash).
- Do not use special characters or spaces.
- **The network name must start with a letter.**
- The names are **not** case sensitive.



Notice!

The AMC2 can be renamed through the controllers IPConfig tool with a name that is not longer than 14 characters. The name has to fulfill the requirements of NetBIOS.

6 UL requirements

Before installing the product in an UL system, read and follow the UL requirements described below.

Depending on the Host Management, the system consists of:

The Access Professional Edition (APE) 3.4 or 3.5 or Building Integration System (BIS) - Access Engine (ACE) 4.5, or AMS 2.0 or 3.0 as the Host Management System. This is an Access Control (UL 294 ALVY) system. It consists of the following devices - all listed to UL 294:

- The maximum number of AMC2 controllers varies depending on the type of license (AMC2-2WCF, downloader version 00.49 or higher, program version 37.xx).
- Every controller can be extended with one AMC2-4WE.
- Every controller can be extended with up to three AMC2-8IOE, AMC2-16IOE or AMC2-16IE in any combination.
- The enclosures AMC2-UL01 (for one device) or AMC2-UL02 (for two devices).
- For every enclosure, a power supply Bosch APS-PSU-60 is necessary, and must be located in the same room as the connected AMC2 device. Recommended maximum distance between power supply unit and AMC2 is 3 m (9.84 ft).

**Notice!**

The use of the burglar alarm, panic hardware, and elevator control have not been evaluated by UL.

**Notice!**

This section applies to APC product versions. ADS product versions have not been evaluated by UL.

For UL compliance, use only UL Listed 26-bit Wiegand format readers.

The following Bosch model card readers were evaluated by UL for compatibility with above-mentioned Bosch Access Host Management System:

- LECTUS secure 1000 WI
- LECTUS secure 4000 WI
- LECTUS secure 5000 WI
- LECTUS secure 9000 WI

6.1 System requirements

6.1.1 Computer

Host system

For detailed information about the needed Operating system and Hardware, please refer to the corresponding installation manual of the used Management system.



Notice!

Computers used for UL installations must be UL listed by the Information Technology Equipment Group (ITE).

6.2 UL 294 level descriptions

The following UL 294 levels apply:

- ACCESS CONTROL DESTRUCTIVE ATTACK LEVEL I - An access control product intended for, but not limited to, a controlled area that is not required to meet the destructive Attack Test.
- ACCESS CONTROL LINE SECURITY LEVEL I - An access control product with no communication line security.
- ACCESS CONTROL ENDURANCE LEVEL IV - An access control product shall operate as intended at rated voltage and current for 100,000 cycles of intended operation.
- ACCESS CONTROL STANDBY POWER LEVEL II - An access control product for units employing Model APS-PSU-60 Power Supply for 12 VDC and 24 VDC Mode. Level II operates for 30 minutes.

6.3 Installation instructions

This system is to be installed indoors within the protected or restricted area.

The UL evaluated configuration requires the following restrictions:

- A connected Host Management System to configure the AMC2 controller, manage card user database, etc. After configuration is done, the AMC2 controller is still able to work as intended, without any connection to the Host Management System. However, alarm status of the system will not be reflected.
- UL evaluated that the protection is set by the Access System Software as supplementary monitoring equipment.
- The enclosure AMC2-UL01 or AMC2-UL02 is necessary. The AMC2 Controller and Extension devices must be installed in one of these enclosures.
- The tamper contact of the AMC2 Controller must be connected to the tamper switch of the enclosure.
- In one enclosure: when using an AMC2 controller and an AMC2 extension board, if the AMC2 Extension board is supplied via the extension interface, the AC fail, DC fail, and BAT fail contacts must be shorted.
- The door locks should be connected as fail safe (NFPA 101).
- For host system connection, only the Ethernet (RJ45) port must be used. **The RS-232 and RS-485 host connections may not be used in UL installations.**
- The RS-485 slave connection may be used for connection to other AMC2 Extension devices only. It may not be used for connection to readers or other accessories.
- All units are to be powered by the Bosch APS-PSU-60 power supply for UL installations. The power supply must be located in the same room as the connected AMC2 device. Recommended maximum distance between power supply unit and AMC2 is 3 m (9.84 ft).

- Wiring methods shall be in accordance with the National Electrical Code (ANSI/NFPA70 - Articles 725 and 800), local codes, and the Authority Having Jurisdiction (AHJ).
- All interconnecting devices and wiring must be UL listed and or/recognized.
- The minimum wire size used for connecting external devices shall be at least 26 AWG, depending on the electrical power consumption.
- Products are not intended to be installed or mounted in air-handling spaces.
- To detect the four states of the input, the voltage drop in the connecting cable may not exceed special values. For UL installations only the RS = 2k Ω and RP = 2k Ω End-of-Line resistors may be used.

The supply line transient protection complying with the Standard for Transient Voltage Surge Suppressors, UL 1449, with a maximum marked rating of 330 V must be used in conjunction with the Host Management System.

The signal line transient protection complying with the requirements for the Standard for Protectors for Data Communication and Fire Alarm Circuits, UL 497B, with the maximum marked rating of 50 V.

The communication circuits and network components connected to the telecommunications network shall be protected by secondary protectors for communication circuits. These protectors shall comply with the Standard for Secondary Protectors For Communication Circuits, UL 497A. These protectors shall be used only in the protected side of the telecommunications network.

The equipment should be installed in a temperature controlled environment. A temperature controlled environment is defined as one that can be maintained between 13 - 35° C (55 - 95° F) by the HVAC system. Twenty-four hours of standby power shall be provided for the HVAC system. The standby power system for the HVAC system may be supplied by an engine driven generator alone. A standby battery is not required to be used.

For UL compliance, use only UL Listed readers.

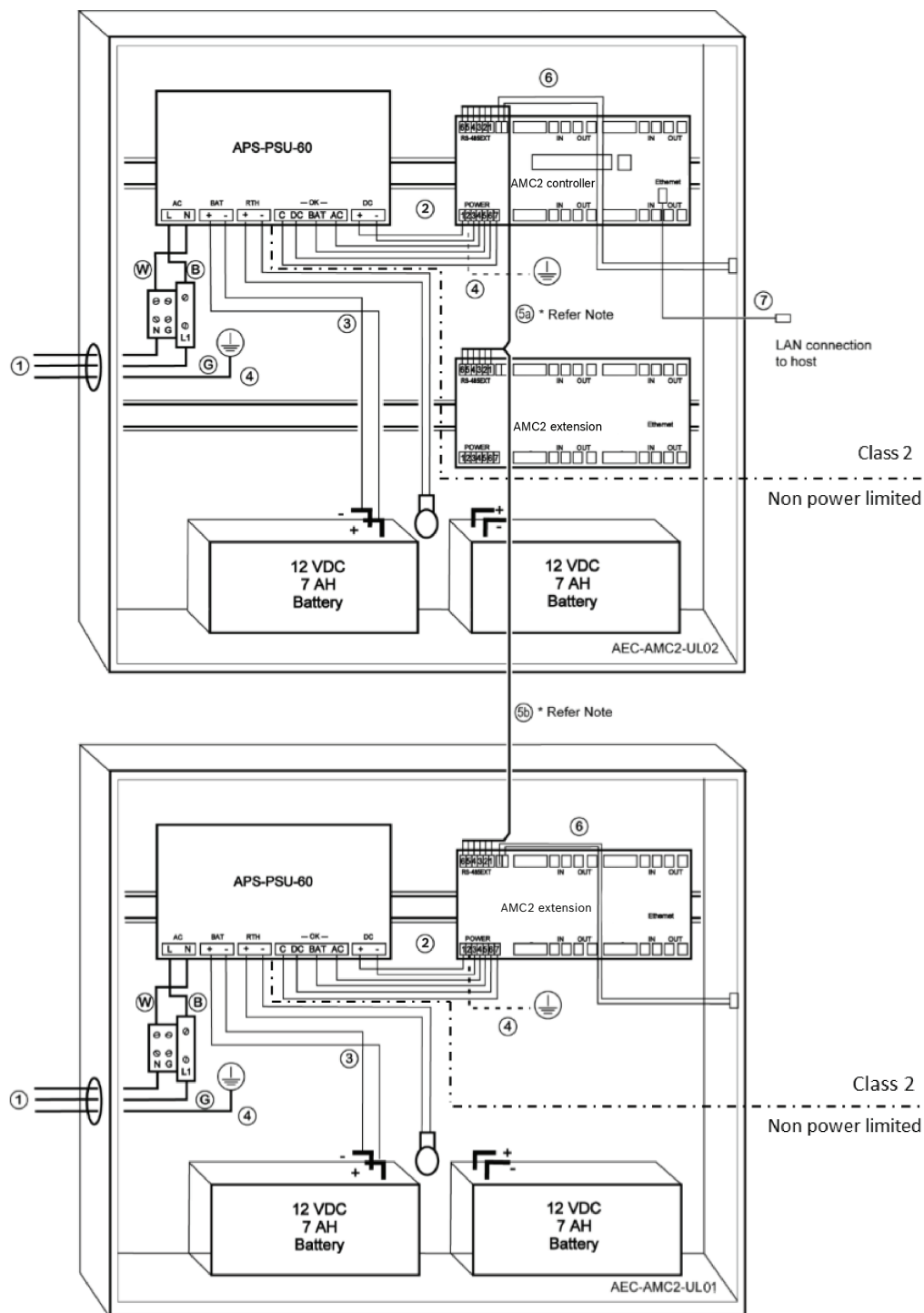



Figure 6.1: Example of mountings with extensions

Position	Description	Position	Description
B	Black / brown	3	Battery connection
		4	Earth cable
W	Blue	5a 5b	R-485 extension connection
G	Green or green / yellow	6	Tamper connection
1	AC power connection	7	Ethernet cable
2	DC power to AMC2		Grounding points



Caution!

Risk of electrical interference.

Make sure to keep the class 2 conductors and the non-power limited conductors strictly separate.

- Avoid any crossing of the conductors of the two categories.
- Guide the conductors of the two categories through different knock-outs of the housing.

6.4 Extended technical specification

6.4.1 RS-485 extension

- RS-485 extension output power rated maximum 2.5 A @ 9.0 VDC to 30 VDC (the voltage output is dependent on board voltage input)

6.4.2 Power consumption

Power input	10 VDC to 30 VDC, maximum of 3 A
Power consumption	5 VA
Total combined output	3 A @ 10 VDC - 12 VDC 2.5 A @ 24 VDC - 30 VDC

7 Troubleshooting

If problems occur read the table below.

Adjust only those controls specified in the installation manual. Improper adjustment of other controls may result in damage, and require extensive work by a qualified technician to restore the unit to normal operation.

If you are unsure of the problem or if the problem persists, contact *After sales support, page 42*.

Problem	Cause	Solution
Display is not working.	<ul style="list-style-type: none"> – Voltage is too low. – Power is off. 	<ul style="list-style-type: none"> – Make sure the power supply has enough voltage to power the controller. – Power up the controller.
Controller is not online.	<ul style="list-style-type: none"> – Network connection is missing. – DIP switch 5 is set to OFF (BPA protocol is selected). 	<ul style="list-style-type: none"> – Plug the Ethernet cable into the controller. – Make sure to configure the Ethernet interface correctly. Refer to <i>Configuring the Ethernet Interface</i> for instructions. – Set DIP switch 5 to ON (SDEB protocol is selected).
Controller does not work as expected.		<ul style="list-style-type: none"> – Switch the power of the controller off and on again. – Check the configuration of the controller. If necessary, delete all configuration data by <i>Resetting the Device to Factory Default</i>. – Reset the controller as described in <i>Resetting the software, page 40</i>.
No connection to BIS and AMS after factory reset.	<ul style="list-style-type: none"> – No connection to access system. 	<ul style="list-style-type: none"> – Check configuration settings within AMS or ACE system. – Check if the controller is activated in the configuration settings.

7.1 Resetting the software

1. Insert the provided screwdriver into the hole until it reaches the reset button as shown in the figure below.
2. Press the reset button with the screwdriver.
3. Look at the LCD display. It will indicate the word **Reset**.
4. Keep the reset button pressed until the LCD display indicates **Release to Reset**.
5. The controller deletes its application program leaving only its bootloader and network setting.

As soon as it is online again, controller's bootloader will download a fresh copy of the application program and configuration. If the problem persists contact after sales support.

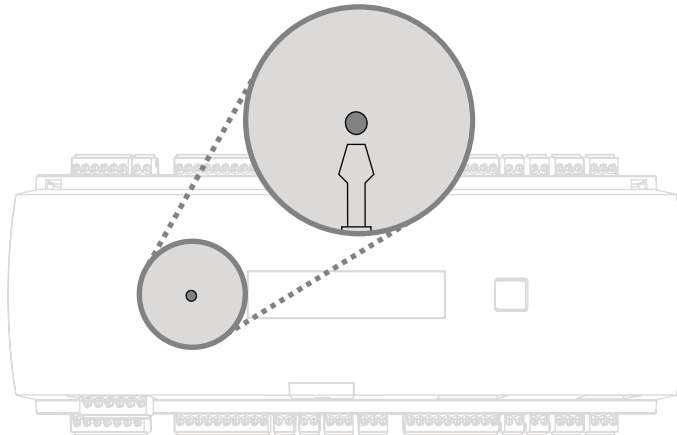

Figure 7.1: Reset button

7.2 Resetting the device to factory default

1. If connected to the Ethernet, release the connection.
2. Open the upper case of the controller as described in *Opening the case*, page 15.
3. Reset the controller as described in *Resetting the software*, page 40.
4. Set all six DIP switches of the RS-485 selector to ON (see figure below).
5. Press the reset button.
6. After completing this procedure, do not forget to set the DIP switches to your preferred position (factory default 1 and 5 to ON).

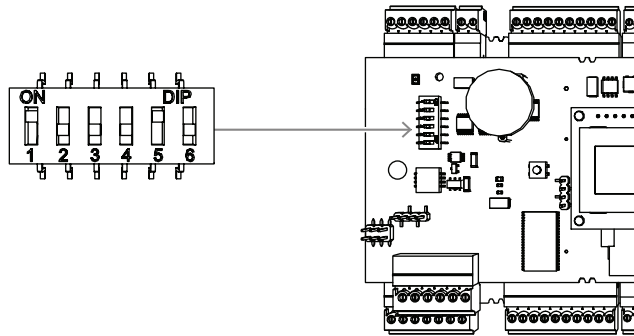

Figure 7.2: DIP switches and delivery status

The controller now has the following network configuration:

- DHCP = 1
- IP = [assigned by DHCP server or “0.0.0.0” if not available]
- Subnet mask = [assigned by DHCP server or “0.0.0.0” if not available]
- Password = no password
 - Create your password in the IP Config settings of the AMC.

8 Service and repair

The controller is backed by a standard warranty of 3 years. Contact your dealer to buy a warranty extension.



Warning!

Risk of electric shock

Opening or removing the covers can expose you to dangerous voltages. An electric shock can cause injuries or death. Do not perform servicing tasks yourself. Refer all servicing to qualified service personnel.

Damage that requires service

Disconnect the controller from the main AC or DC power source and refer servicing to qualified service personnel under the following conditions:

- If the power supply cord or plug is damaged.
- If liquid has been spilled or an object has fallen into the controller.
- If the controller has been exposed to water and/or humid weather (rain, snow, etc.).
- If the controller has been dropped or the cabinet damaged.
- If the controller shows a distinct change in performance.

Safety check

Upon completion of service or repair work on the controller, ask the service technician to perform safety checks to ensure that the controller operates properly.

After sales support

For more information, visit www.boschsecurity.com/xc/en/support/.

9

Disposal

Old electrical and electronic equipment

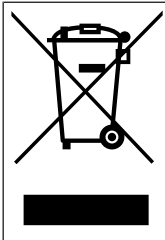

This product and/or battery must be disposed of separately from household waste. Dispose such equipment according to local laws and regulations, to allow their reuse and/or recycling. This will help in conserving resources, and in protecting human health and the environment.



Batteries may be subject to specific country regulations and must not be disposed in the general waste.

Data security

According to the General Data Protection Regulation (GDPR), companies are obliged to properly delete or destroy data carriers containing personal data if they are no longer needed. Since access controllers and readers can contain sensitive information, these should be treated and disposed of as data carriers after use.

The controller has a CF card as storage medium. When disposing of the controller, ensure that the CF card or the complete controller is destroyed or disposed of in accordance with the Local Data Protection Ordinance.

10 Technical specifications

Mechanical

Type	DIN rail mounting
Housing material	ABS and Polycarbonate (UL94V-0)
Dimensions (H × W × D)	232 mm × 90 mm × 63 mm (9.13 in. × 3.54 in. × 2.48 in.)
Weight	681 g
Color	White

System specifications

Memory	<ul style="list-style-type: none"> – Serial EEPROM – Pluggable 2 GB compact flash
Reader interfaces	<ul style="list-style-type: none"> – 4× Wiegand Power 280 mA each 11.8 VDC to 12 VDC
Host interface	<ul style="list-style-type: none"> – Ethernet 10/100 MBit/s – RS485 – AES128 encrypted
Extension interface	<ul style="list-style-type: none"> – RS485 9,6 kBit/s, no parity, 8 bit, 2 stop bit
Outputs	<ul style="list-style-type: none"> – 8× relay outputs – 30 V DC max. (switching voltage) – 1,25 A max. (switching current) @ 30Vdc – Operation mode: wet and dry
Inputs	8 analog inputs with tamper detection
Power consumption	5 VA
Tamper	2-wire input for external tamper contact
Reset button	Yes
Power	<ul style="list-style-type: none"> – 10 VDC to 30 VDC – 60 VA max. – 55 VA (available for external devices)
Display	LCD

Environmental

Temperature	0 °C to +45 °C (32 °F to 113 °F)
Environmental rating	IP 30
RoHS	Compliant



Notice!

The voltage drop from the power supply to the controller affects the interfaces of the controller. The total drop must not exceed 2V.



Notice!

To determine the environmental impact of an installation, take the most extreme values of all participating devices into account.



Notice!

To determine the vulnerability of an installation, take the most restrictive values of all participating devices into account.

Access Modular Controller Series

Hazardous substance table according to SJ/T 11364-2014						
	Pb (Pb)	Hg (Hg)	Cd (Cd)	Cr 6+ (Cr 6+)	PBB (PBB)	PBDE (PBDE)
Housing & Enclosures	o	o	o	o	o	o
PCBA	x	x	o	o	o	o
Connectors	x	o	o	o	o	o
Electronic Components	x	o	o	o	o	o
Plastic Materials	o	o	o	o	o	o
Metal Materials	o	o	o	o	o	o
This table was created according to the provisions of SJ/T 11364						
O: The content of such hazardous substance in all homogeneous materials of such component is below the limit defined in GB/T 26572						
X: The content of such hazardous substance in a certain homogeneous material is above the limit defined in GB/T 26572						

11 Appendices

11.1 Connecting diagrams

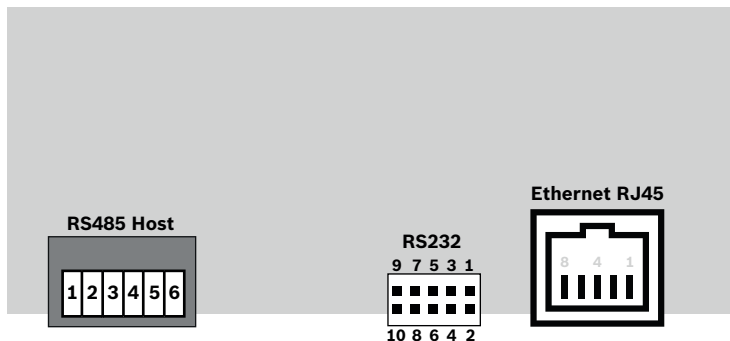

Figure 11.1: Connectors on upper PCB

The RS-485 interface is not supported by:

- BIS 4.9.1 and later
- AMS 4.0 and later.

	1	NC (configurable shield)
	2	Data RxTx+ (2-wire) Data Rx+ (4-wire)
	3	Data RxTx- (2-wire) Data Rx- (4-wire)
	4	PAG
	5	Data Tx+ (4-wire)
	6	Data Tx- (4-wire)

Table 11.4: RS-485 host on upper PCB

	1	TXD+
	2	TXD-
	3	RXD+
	4	Not connected
	5	Not connected
	6	RXD-
	7	Not connected
	8	Not connected

Table 11.5: Ethernet Network socket (RJ45)

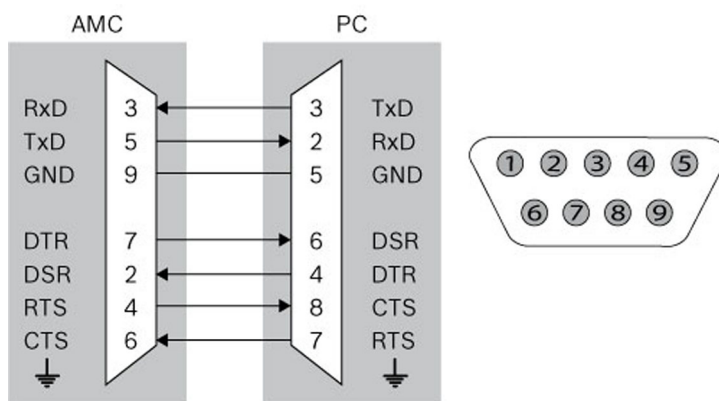

Figure 11.2: Interconnect diagram of the project-specific interface

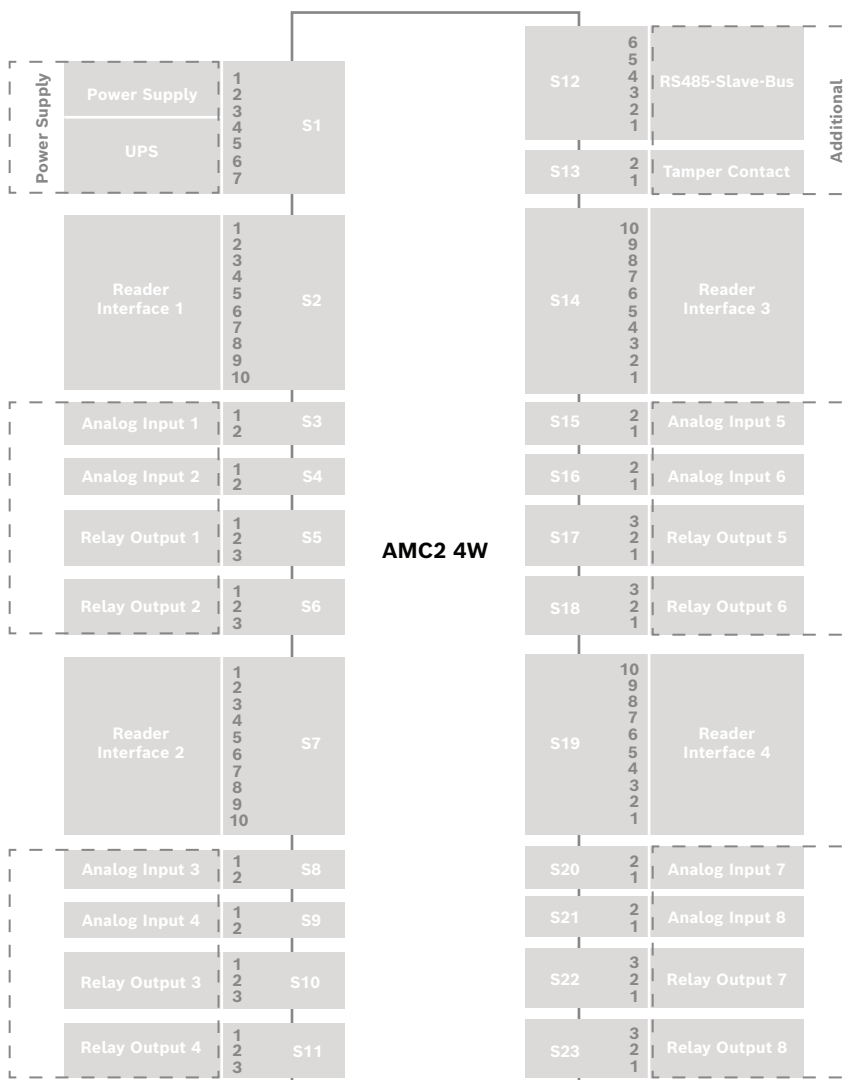

Figure 11.3: Connector blocks of the AMC2-4W



	1	Power supply, DC positive (10V - 30V)
	2	Shield 
	3	Power supply (0V)
	4	UPS (power good signal) - AC
	5	UPS (power good signal) - Battery
	6	UPS (power good signal) - DC
	7	UPS (power good signal) - Common

Table 11.6: Power supply

	1	red	Power supply (12V)
	2	black	Power supply (GND)
	3	green	Data 0
	4	white	Data 1
	5	drain	GND
	6	orange	green LED
	7	brown	red LED
	8	yellow	Beeper
	9	blue	Hold
	10	violet	Card Present

Table 11.7: Wiegand interface AMC

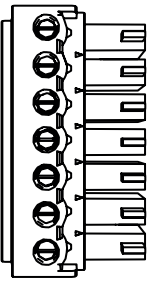

Notice!

For reader settings refer to the respective reader manual.

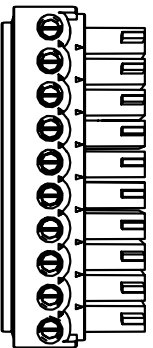
	1	Analog Input, in
	2	Analog Input, out

Table 11.8: Analog input

	1	Relay Output, normally open
	2	Relay Output, common
	3	Relay Output, normally closed

Table 11.9: Relay output

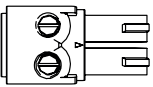

1	Power supply (10V - 30V)
2	Power supply GND
3	Shield 
4	Data RxTx+
5	Data RxTx-
6	PAG

Table 11.10: Host / Extension interface

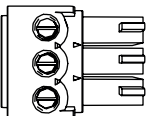
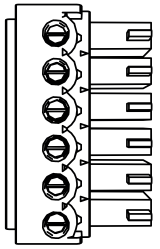

1	Tamper Contact, in
2	Tamper Contact, out

Table 11.11: External tamper contact

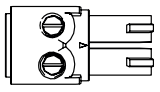
11.2 Status display

11.2.1 Bootloader V00.49

Push	Display (Example)	Description
0	V00.49 dd.mm.yy	Bootloader version by factory dd.mm.yy release date of the firmware
1	S/N1: 0910024419	Serial number 18 digits - Part1 10 digits
2	S/N2: 22850034	Part 2 - 8 digits
3	11.18 12:24:18 S	Current date and time (MM.DD hh:mm:ss) (S) = daylight saving
4	MAC 001B860012AB	Network device address (MAC)
5	N AMC-1234-5678	Network name of the controller (max. 14 char.) See <i>Configuring Ethernet interface, page 33.</i>
6	I 192.168.10.18	IP-address of the controller
7	G 192.168.10.255	IP-address of the gateway
8	M 255.255.255.0	Subnetmask
9	H 192.168.10.10	IP-address of the host computer
10	DHCP 1	DHCP-status: 1 = on; 0 = off
11	D 192.168.10.1	IP-address of the DNS server
12	Host: + "C"	Host activity: + = online - = offline "C" = Counter (0 to 9) of the received data packages from the host interface. RS 485 Bus connection: A = Address 1 ... H = Address 8

11.2.2 Firmware until 6x.45, 37.60

Push	Display (Example)	Description
0	Vaa.bb 01.05.17	aa = Reader Protocol Version 37 - Wiegand, 60 - Lbus, 61 - BG900, 62 - OSDP bb = Firmware Version 01.05.17 release date of the firmware (dd.mm.yy)
1	S/N1: 0910024419	Serial number 18 digits - Part1 10 digits
2	S/N2: 22850034	Part 2 - 8 digits
3	11.18 12:24:18 S	Current date and time (MM.DD hh:mm:ss) (S) = daylight saving
4	Dig. IO: ::::::::::::::	Display of the digital contacts: the input signals set will be shown with an extension above - output signals with an extension below. The first eight digits display the controller's signals. The second eight digits display the extension board's signals
4a	Dig. I1: ::::::::::::::	If there are I/O-Boards connected, the signals will be shown on separate pages.
4b	Dig. I2: ::::::::::::::	
4c	Dig. I3: ::::::::::::::	
5	MAC 001B860012AB	Network device address (MAC)
6	N AMC-1234-5678	Network name of the controller (max. 14 char.) See <i>Configuring Ethernet interface, page 33</i> .
7	I 192.168.10.18	IP-address of the controller
8	G 192.168.10.255	IP-address of the gateway
9	M 255.255.255.0	Subnetmask
10	H 192.168.10.10	IP-address of the host computer
11	DHCP 1	DHCP-status: 1 = on 0 = off
12	D 192.168.10.1	IP-address of the DNS server
13	Host: + "C"	Host activity: + = online - = offline "C" = Counter (0 to 9) of the received data packages from the host interface. RS-485 Bus connection: A = Address 1 ... H = Address 8
14	HSC state: x	Host secure status: 1 = enable 2 = disable

11.2.3 Firmware xx.61, 37.71

Push	Display (Example)	Description
0	AMC-xxxxx	Display firmware variants: - Bootloader - WIEGAND - LBUS - OSDP - BG900
1	Vxx.xx xx.xx.xx	aa = Reader Protocol Version 37 - Wiegand, 60 - Lbus, 61 - BG900, 62 - OSDP bb = Firmware Version 01.05.17 release date of the firmware (dd.mm.yy)
2	S/N1: 0910024419	Serial number 18 digits - Part1 10 digits
3	S/N2: 22850034	Part 2 - 8 digits
4	11.18 12:24:18 S	Current date and time (MM.DD hh:mm:ss) (S) = daylight saving
5	Dig. IO: :::::::::::::: (only available with	Display of the digital contacts: the input signals set will be shown with an extension above - output signals with an extension below. The first eight digits display the controller's signals. The second eight digits display the extension board's signals (Not available for Bootloader FW)
5a	Dig. I1: ::::::::::::::	If there are I/O-Boards connected the signals will be shown on separate pages. (Not available for Bootloader FW)
5b	Dig. I2: ::::::::::::::	
5c	Dig. I3: ::::::::::::::	
6	MAC 001B860012AB	Network device address (MAC)
7	N AMC-1234-5678	Network name of the controller (max. 14 char.) See <i>Configuring Ethernet interface, page 33</i> .
8	I 192.168.10.18	IP-address of the controller
9	G 192.168.10.255	IP-address of the gateway
10	M 255.255.255.0	Subnetmask
11	H 192.168.10.10	IP-address of the host computer
12	DHCP 1	DHCP-status: 1 = on 0 = off
13	D 192.168.10.1	IP-address of the DNS server
14	Host: + "C"	Host activity: + = online - = offline "C" = Counter (0 to 9) of the received data

		packages from the host interface. RS 485 Bus connection: A = Address 1 ... H = Address 8
15	HSC state: x	Host secure status: 1 = enable 2 = disable (Not available for Bootloader FW)

11.2.4

Firmware xx.62, 37.72

This firmware supports DTLs. For details on how to set the required device communication password, refer to the configuration manual of the host system.

- If a brand-new AMC is connected to a host system supporting DTLs, the AMC will be configured with DHCP active and its IP address will be set to a device-specific link-local IP address in the range 169.254.0.0/16.
- If the network is operating with a DHCP server, the AMC will get its network configuration automatically from the DHCP server.
- If the network is operating without a DHCP server, the link-local address will remain active until otherwise configured via the AMCIConfig tool.

Push	Display (Example)	Description
0	AMC-xxxxx	Display firmware variants: - Bootloader - WIEGAND - LBUS - OSDP - BG900
1	Vxx.xx xx.xx.xx	aa = Reader Protocol Version 37 - Wiegand, 60 - Lbus, 61 - BG900, 62 - OSDP bb = Firmware Version 01.05.17 release date of the firmware (dd.mm.yy)
2	S/N1: 0910024419	Serial number 18 digits - Part1 10 digits
3	S/N2: 22850034	Part 2 - 8 digits
4	11.18 12:24:18 S	Current date and time (MM.DD hh:mm:ss) (S) = daylight saving
5	Dig. IO: :::::::::::::: (only available with	Display of the digital contacts: the input signals set will be shown with an extension above - output signals with an extension below. The first eight digits display the controller's signals. The second eight digits display the extension board's signals. (Not available for Bootloader FW)
5a	Dig. I1: ::::::::::::::	If there are I/O-Boards connected, the signals will be shown on separate pages. (Not available for Bootloader FW)
5b	Dig. I2: ::::::::::::::	
5c	Dig. I3: ::::::::::::::	
6	MAC 001B860012AB	Network device address (MAC)

7	N AMC-1234-5678	Network name of the controller (max. 14 char.) See <i>Configuring Ethernet interface, page 33.</i>
8	I 192.168.10.18	IP-address of the controller
9	G 192.168.10.255	IP-address of the gateway
10	M 255.255.255.0	Subnetmask
11	H 192.168.10.10	IP-address of the host computer
12	DHCP 1	DHCP-status: 1 = on 0 = off
13	D 192.168.10.1	IP-address of the DNS server
14	Host: + "CCCC"	Host activity: + = online - = offline "CCCC" = Counter (0 to 9) of the received data packages from the host interface.
16a	Key1: ZACM-85GZC	Random LCD Key, which can be used to authenticate the connection at the controller configuration tool to set the DCP. The key is generated anew with each power cycle of the AMC, if no DCP has been set. Splitted over 3 displays.
17a	Key2: GUZY-KJUN3	Random LCD Key Part2
18a	Key3: GSJ6-HOP43	Random LCD Key Part3
16b	Key: Customized	DCP set



Support

Access our **support services** at www.boschsecurity.com/xc/en/support/.

Bosch Security and Safety Systems offers support in these areas:

- [Apps & Tools](#)
- [Building Information Modeling](#)
- [Warranty](#)
- [Troubleshooting](#)
- [Repair & Exchange](#)
- [Product Security](#)



Bosch Building Technologies Academy

Visit the Bosch Building Technologies Academy website and have access to **training courses**, **video tutorials** and **documents**: www.boschsecurity.com/xc/en/support/training/

Bosch Security Systems B.V.

Torenallee 49

5617 BA Eindhoven

Netherlands

www.boschsecurity.com

© Bosch Security Systems B.V., 2023

Building solutions for a better life.

202308221653